

Roll Your Own Ijunggrenaudio.com

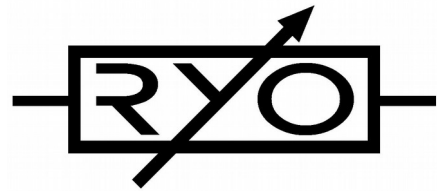

Altered States version 1.0

Bills Of Material **Bold = PCB1**

Qty	Value	Device	Parts	Comment
12	1N4148	Diode	D6, D7, D8, D9, D12, D13, D14, D15, D16, D17, D18, D19	Small signal diode
2	1N5818	Diode	D1, D2	Schottky rectifier diode. 1N5817-1N5819 or SB130
4	1N750 4.7V	Zener diode	D4, D5, D10, D11	Zener Diode 1N750 or other 4.7V
4	220p	Capacitor	C19, C21, C37, C39	C0G ceramic 1%, 2.5 or 5mm pin pitch
30	100n	Capacitor	C1, C2, C7, C8, C9, C10, C12, C13 , C14, C15, C17, C18, C25, C26 , C27, C29, C30, C31, C32, C43, C44, C45, C46, C47 , C48, C49, C50, C51 , C54, C55	X7R ceramic 2.5mm pin pitch
4	15p	Capacitor	C23, C34, C41, C53	Any ceramic 2.5mm pin pitch
8	560p	Capacitor	C16, C20, C22, C24, C36, C38, C40, C42	Any ceramic 2.5mm pin pitch
1	5x2 pin	Connector	POWER	POWER CONNECTOR
7	10u	Electrolytic	C3, C4, C11, C28, C33 , C35, C52	Electrolytic, 2mm pin pitch, 5mm dia, min 25V C33 and C52 max 9mm tall
2	100u	Electrolytic	C5, C6	Electrolytic, 2.5mm pin pitch, 6-6.3mm dia, min 25V
18	3.5mm	Jack	J1, J2, J3, J4, J5, J6, J7, J8, J9, J10, J11, J12, J13, J14, J15, J16, J17, J18	Thonkicon / Inline
2	Orange	LED 3mm	L1, L2	Low lumen
1	LM4040 5V	Volt ref diode	D3	
4	8x1 pin	Socket strip	PCB1-CON1, PCB1-CON2, PCB1-CON3, PCB1-CON4	8x1 socket strip
4	8x1 pin	Pin strip	PCB2-CON1, PCB2-CON2, PCB2-CON3, PCB2-CON4	8x1 pin strip
2	A100k	Potentiometer	POT1, POT7	Metal shaft 9mm snap in panel mount
6	B22k	Potentiometer	POT3, POT4, POT5, POT9, POT10, POT11	Metal shaft 9mm snap in panel mount, B20k – B25k
4	B100k	Potentiometer	POT2, POT6, POT8, POT12	Tall plastic shaft with indicator 9mm snap in
2	72V/0.25A	PPTC	F1, F2	Auto Resettable Fuse PPTC (Polyswitch)
36	100k	Resistor	R5 , R8, R20, R21, R22, R34, R36, R37, R38, R39, R40, R42, R43, R49 , R56, R57, R62, R63, R67 , R70, R81, R82, R83, R95, R97, R98, R99, R100, R101, R103, R104, R108 , R116, R117, R122, R123	Max 7mm 1% (usually 1/4W)
6	12k	Resistor	R26, R46 , R51, R87, R105 , R111	Max 7mm 1% (usually 1/4W)
6	15k	Resistor	R13, R48 , R59, R74, R107 , R119	Max 7mm 1% (usually 1/4W)
2	27k	Resistor	R14, R75	Max 7mm 1% (usually 1/4W)
14	1k	Resistor	R9, R15, R18 , R52, R53, R58, R71, R76, R79 , R112, R113, R118 , R128, R130	Max 7mm 1% (usually 1/4W)
20	200k	Resistor	R7, R28, R29, R30, R41 , R54, R55, R64, R65, R66 , R69, R89, R90, R91, R102 , R114, R115, R124, R125, R126	Max 7mm 1% (usually 1/4W)
3	249R	Resistor	R45, R50, R109	Max 7mm 1% (usually 1/4W); R45 240-270R; R50 and R109 LED brightness 220-270R
8	30k	Resistor	R10, R16, R27 , R72, R77, R88, R131, R132	Max 7mm 1% (usually 1/4W)
2	390k	Resistor	R12, R110	Max 7mm 1% (usually 1/4W)
10	4.7k	Resistor	R1, R25, R33, R44, R47 , R86, R94, R106 , R127, R129	Max 7mm 1% (usually 1/4W)
8	470R	Resistor	R11, R17, R24, R35, R73, R78, R85, R96	Max 7mm 1% (usually 1/4W)
9	47k	Resistor	R2, R3, R4, R23, R31, R32, R84, R92, R93	Max 7mm 1% (usually 1/4W)
4	5.6k	Resistor	R60, R61, R120, R121	Max 7mm 1% (usually 1/4W)
4	680k	Resistor	R6 , R19, R68 , R80	Max 7mm 1% (usually 1/4W)
2	SPDT ON-ON	Toggle switch	S1, S2	SPDT ON-ON
1	DIP8	IC socket	IC1	8 pin IC socket
8	DIP14	IC socket	IC2 , IC3, IC4 , IC5, IC6 , IC7, IC8 , IC9	14 pin IC socket
3	DIP16	IC socket	IC10, IC11, IC12	16 pin IC socket
1	LM13700	OTA	IC12	
1	LM358	OpAmp	IC1	
2	V2164	VCA	IC10, IC11	Cool Audio
8	TL084	OpAmp	IC2 , IC3, IC4 , IC5, IC6 , IC7, IC8 , IC9	TL074 or TL084
1	100R	Trimmer	TRIM1	3296W compatible
4	10k	Trimmer	TRIM2, TRIM3, TRIM4, TRIM5	3296W compatible

1		PCB1
1		PCB2
1		Panel
8		Screws
4		spacers
4		nuts
6		cream knobs
2		red knobs
1		Power cable 10-16p

PCB pictures

PCB1

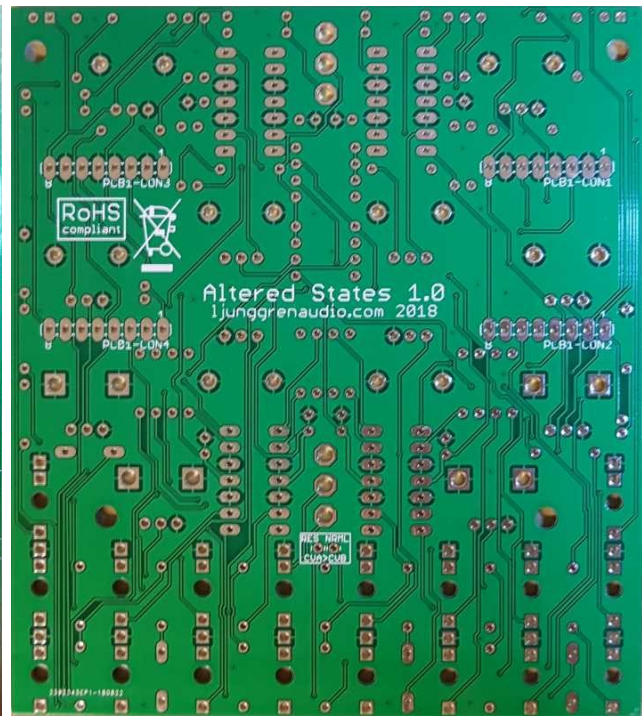
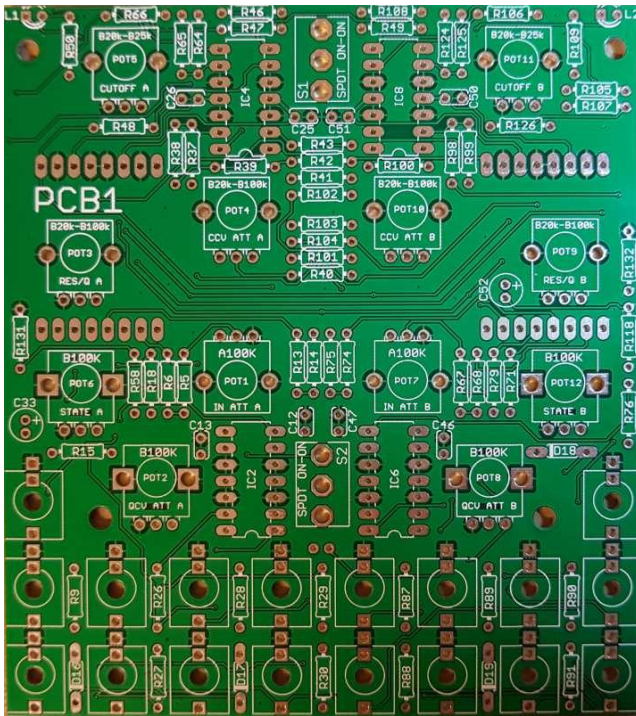

PCB2

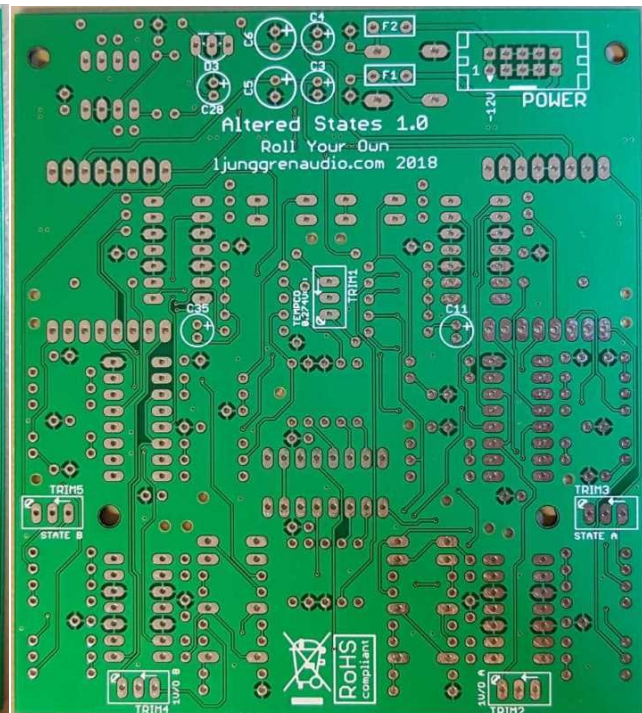
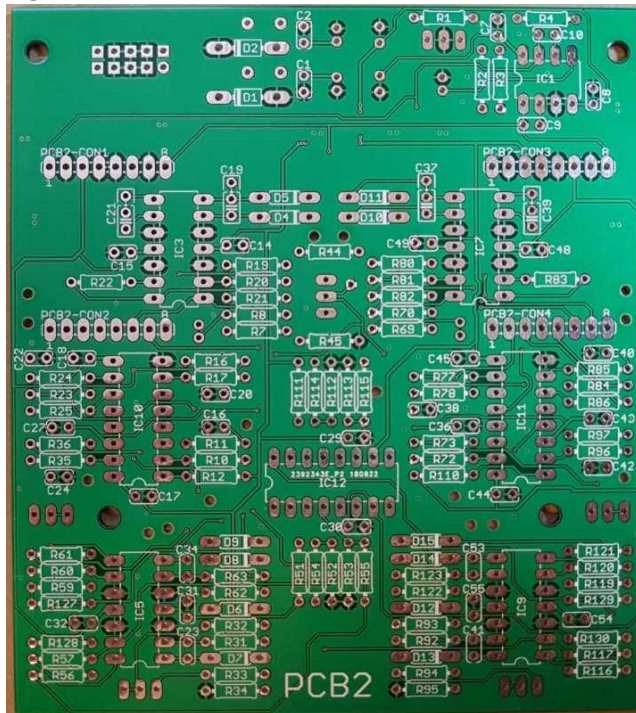

You can find the calibration instructions on the last page.

Assembly instructions

We start with PCB2.

Step 1

Solder small diodes. Diodes are sensitive to mounting direction, make sure the stripe on the diode match the stripe on the silkscreen.

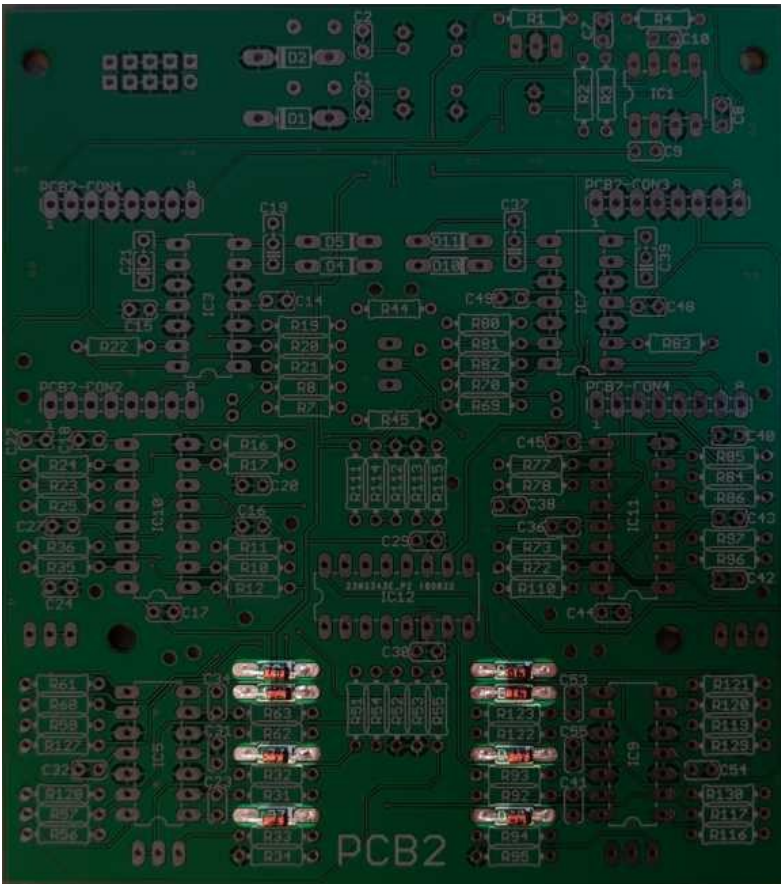

D6, D7, D8, D9, D12, D13, D14, D15 1N4148 8pcs

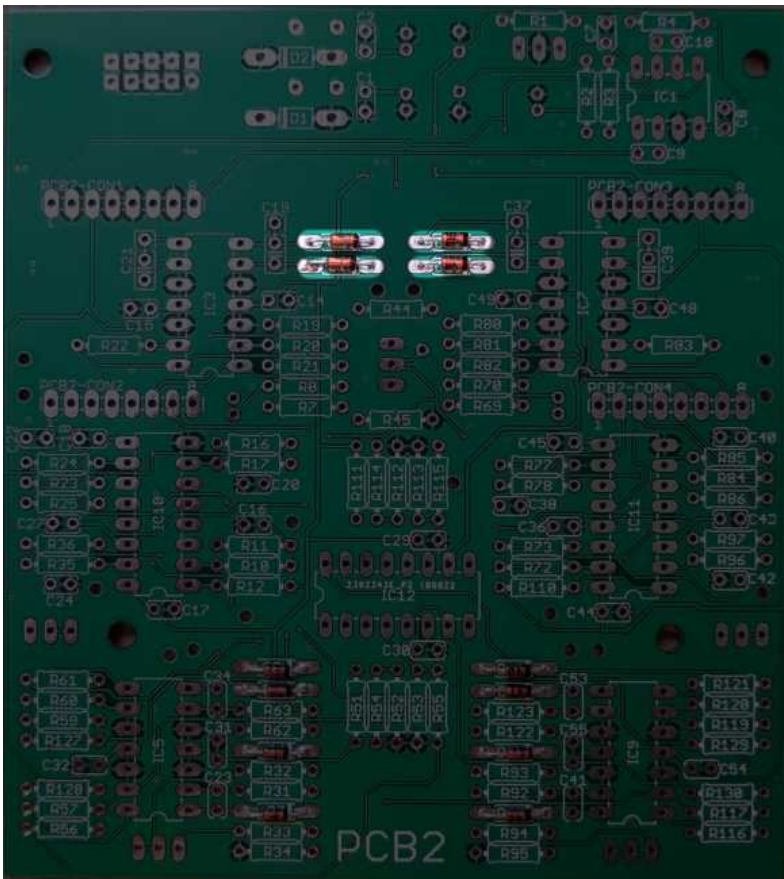

D4, D5, D10, D11 1N750 4pcs

Step 2

Solder resistors. Resistors are not sensitive to mounting direction.

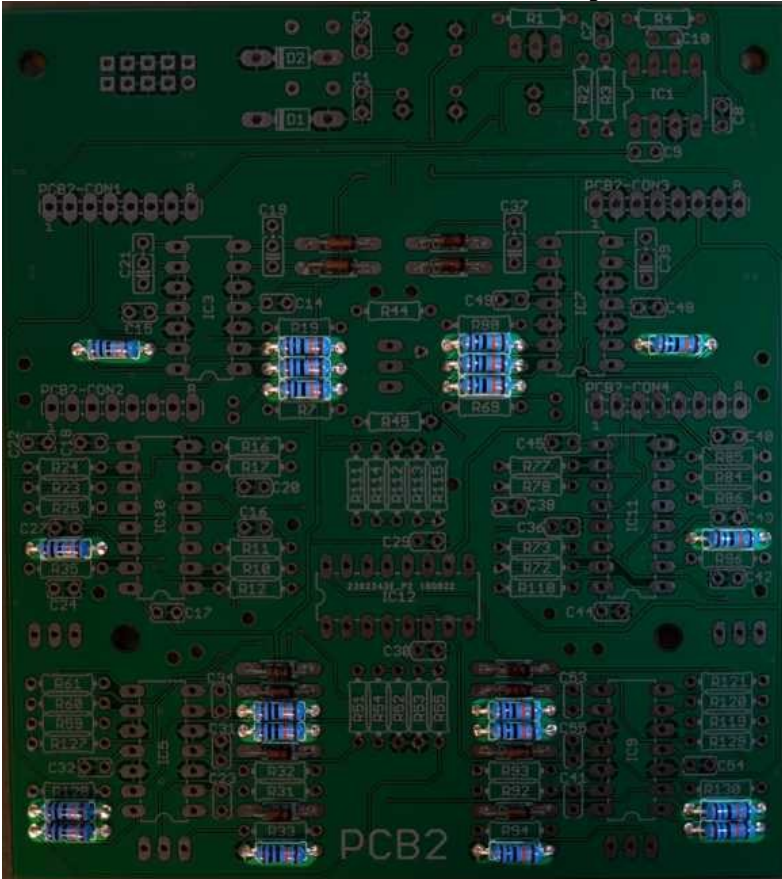

R8, R20, R21, R22, R34, R36, R56, R57, R62, R63, R70, R81, R82, R83, R95, R97, R116, R117, R122, R123
100K 20pcs

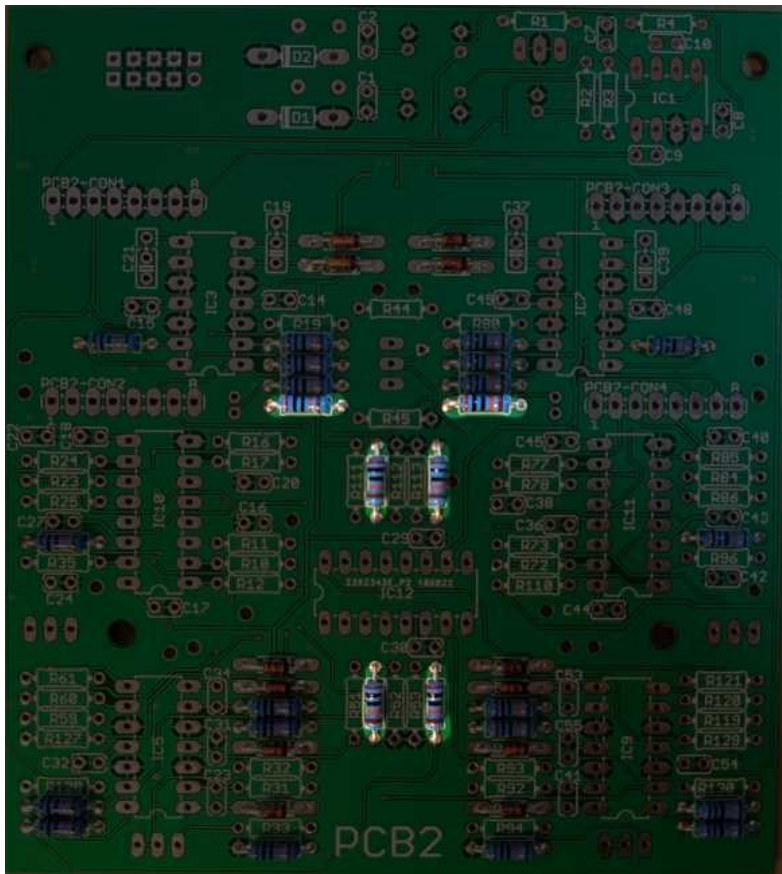

R7, R54, R55, R69, R114, R115 200K 6pcs

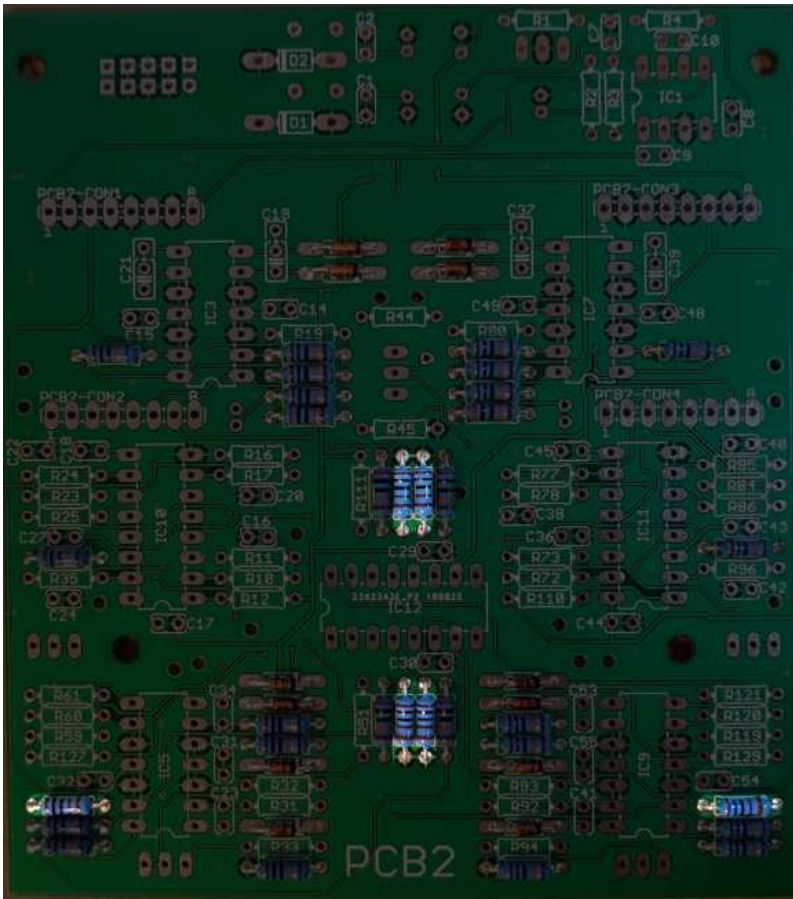

R52, R53, R112, R113, R128, R130 1K 6pcs

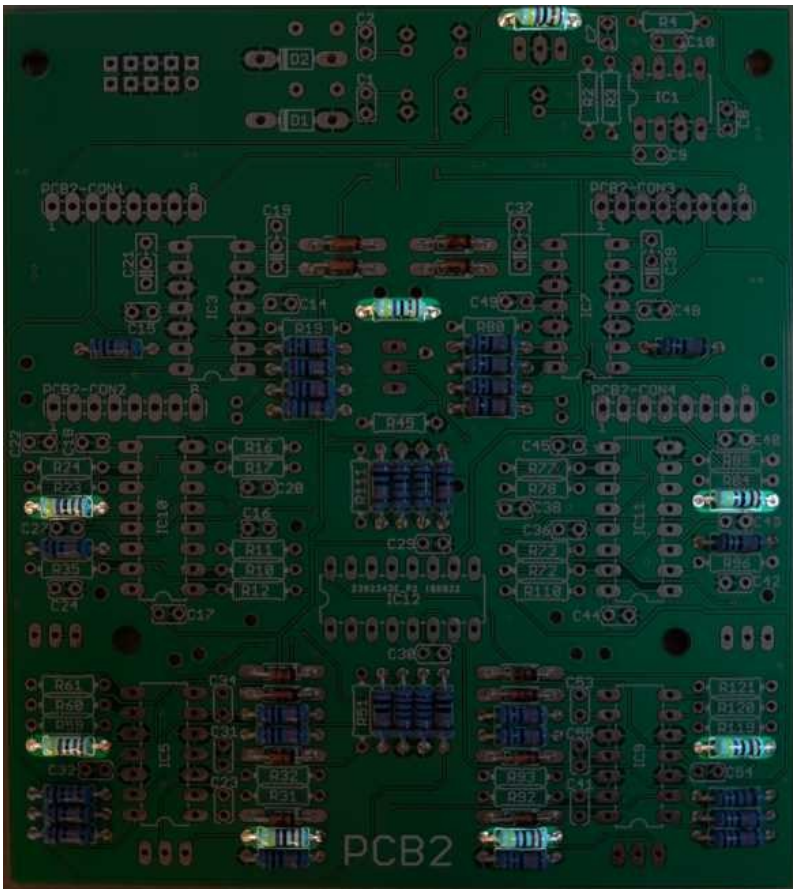

R1, R25, R33, R44, R86, R94, R127, R129 4.7K 8pcs

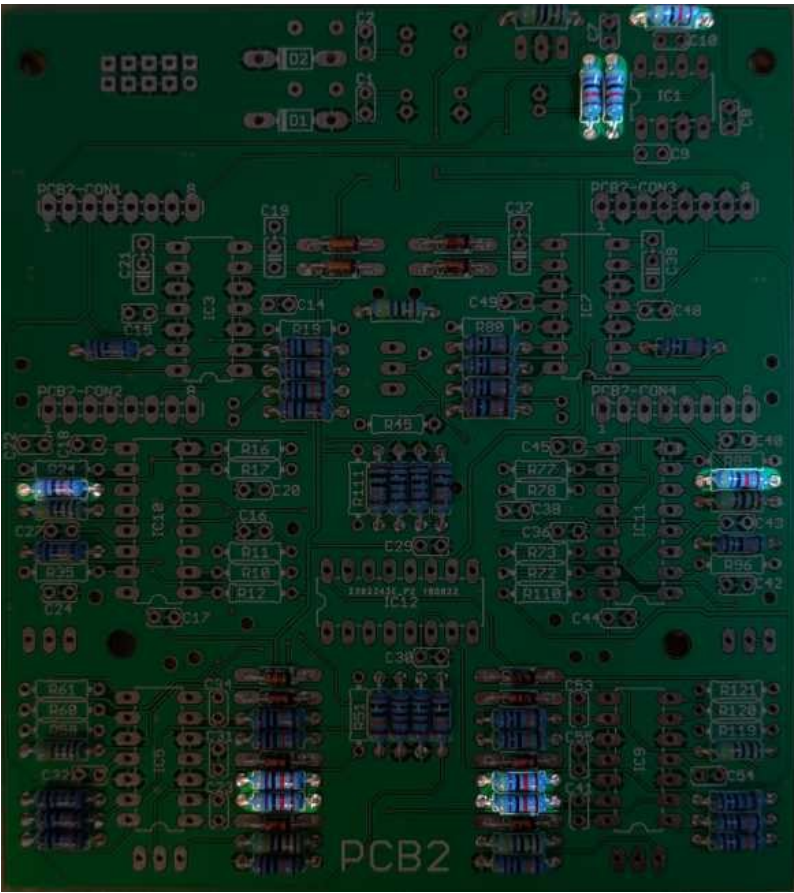

R2, R3, R4, R23, R31, R32, R84, R92, R93 47K 9pcs

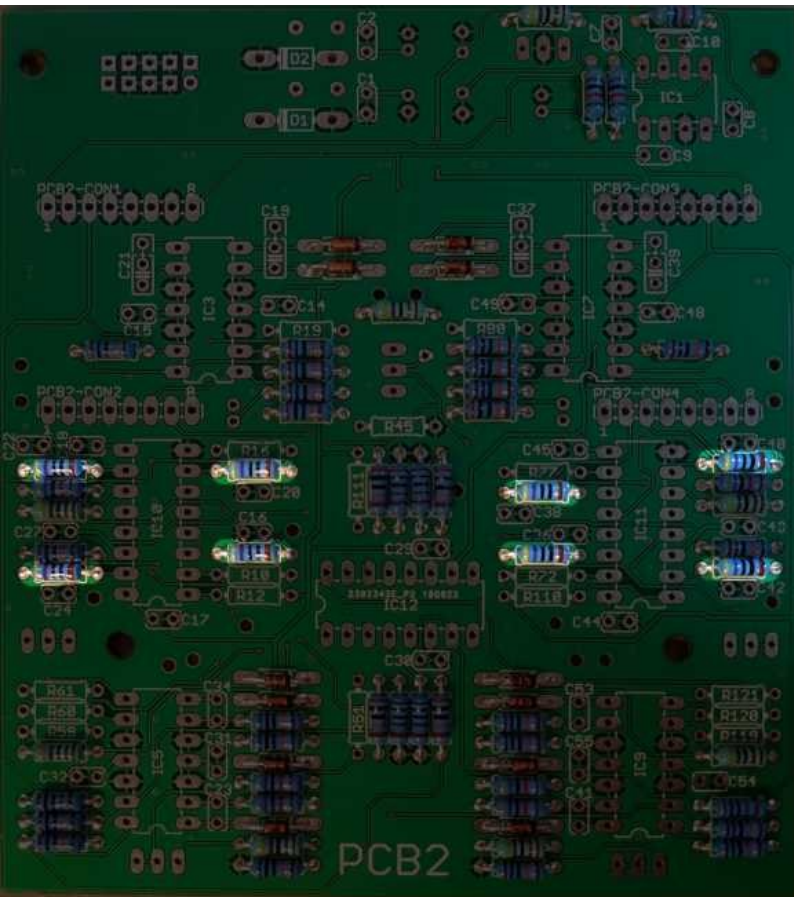

R11, R17, R24, R35, R73, R78, R85, R96 470R 8pcs

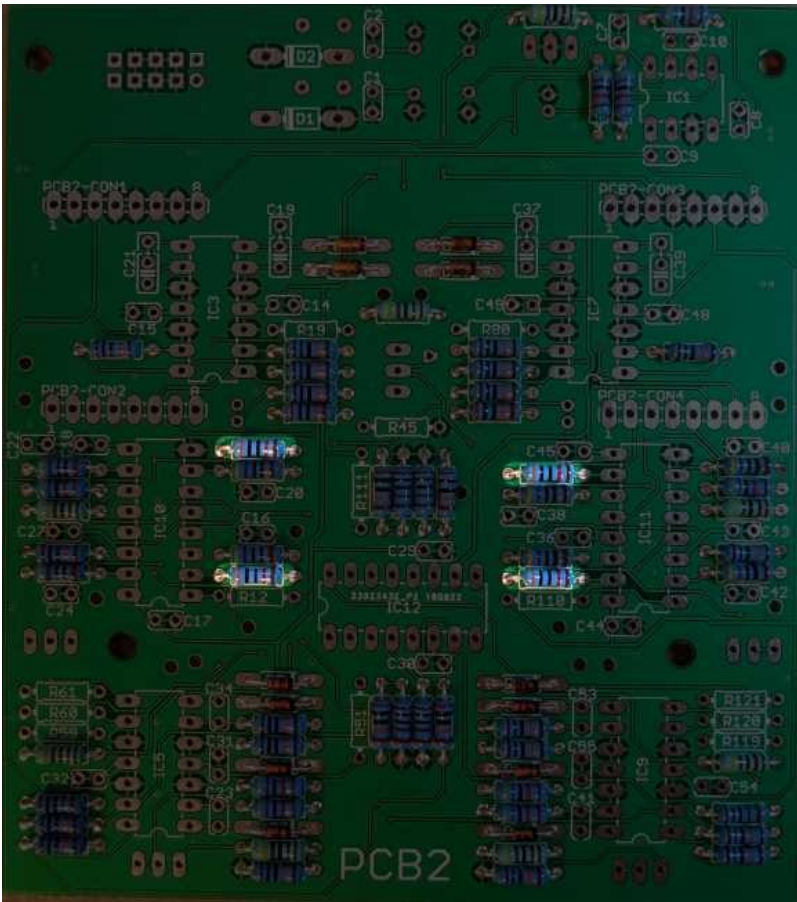

R10, R16, R72, R77 30K 4pcs

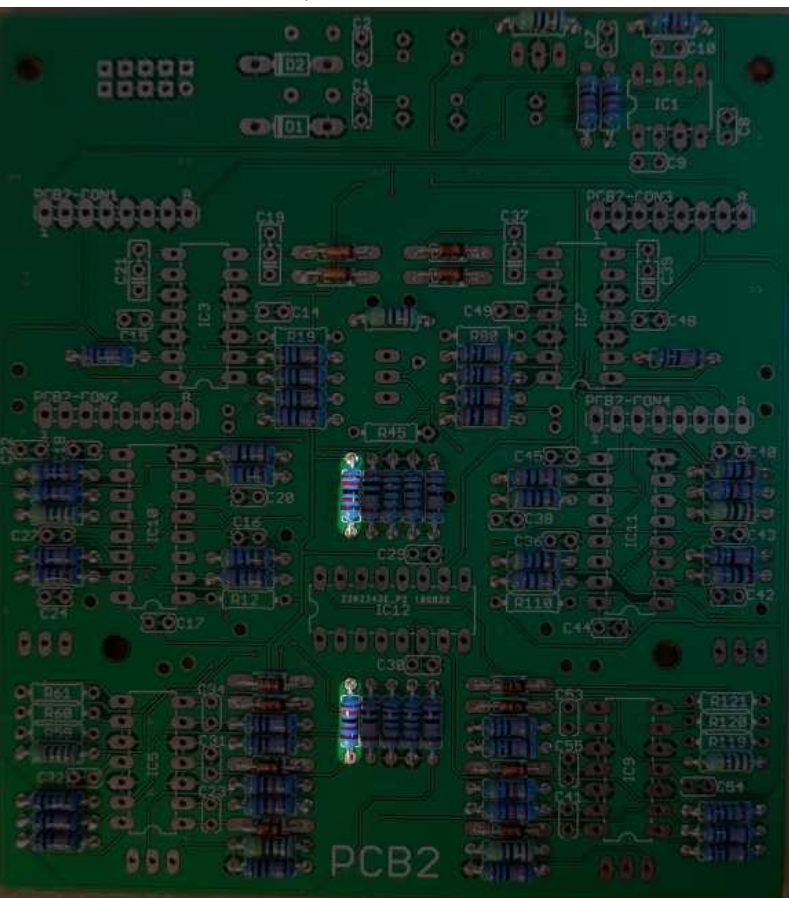

R51, R111 12K 2pcs

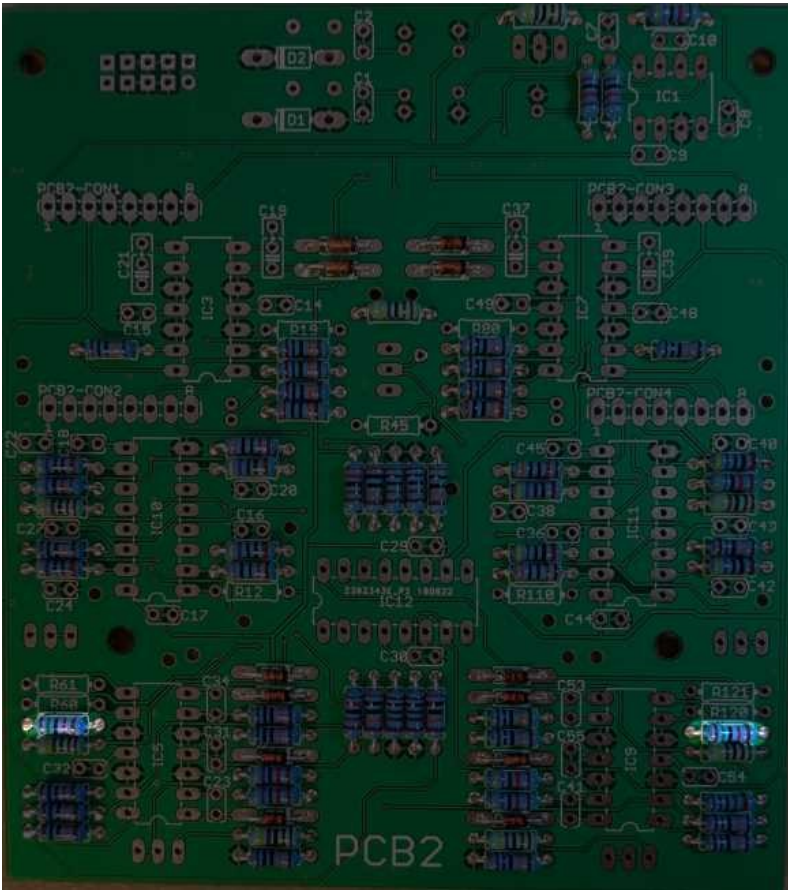

R59, R119 15K 2pcs

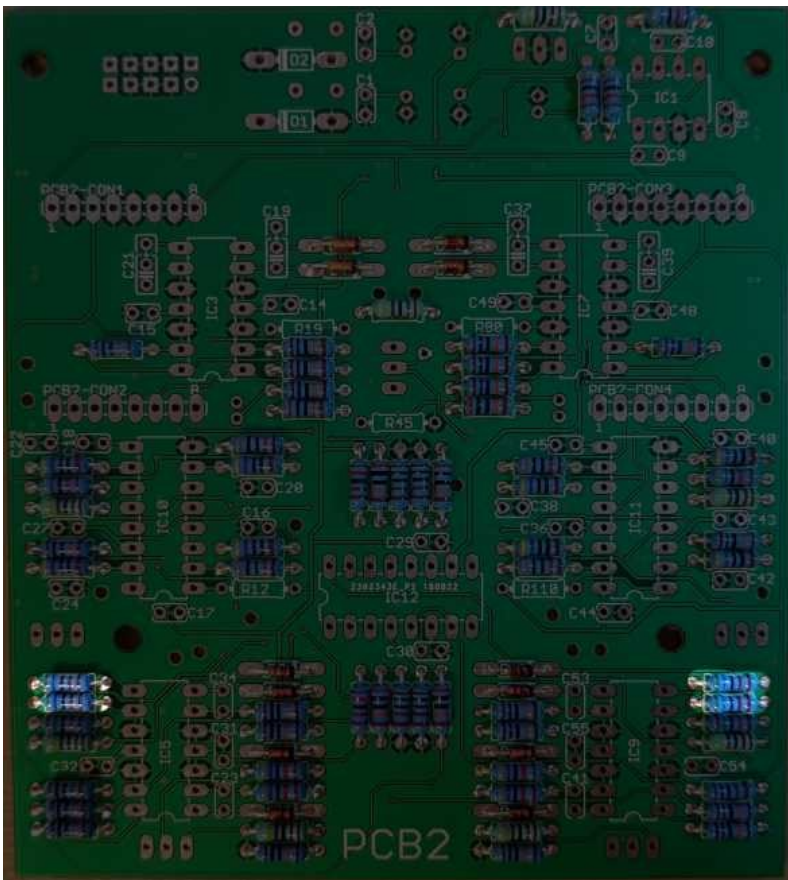

R60, R61, R120, R121 5.6K 4pcs

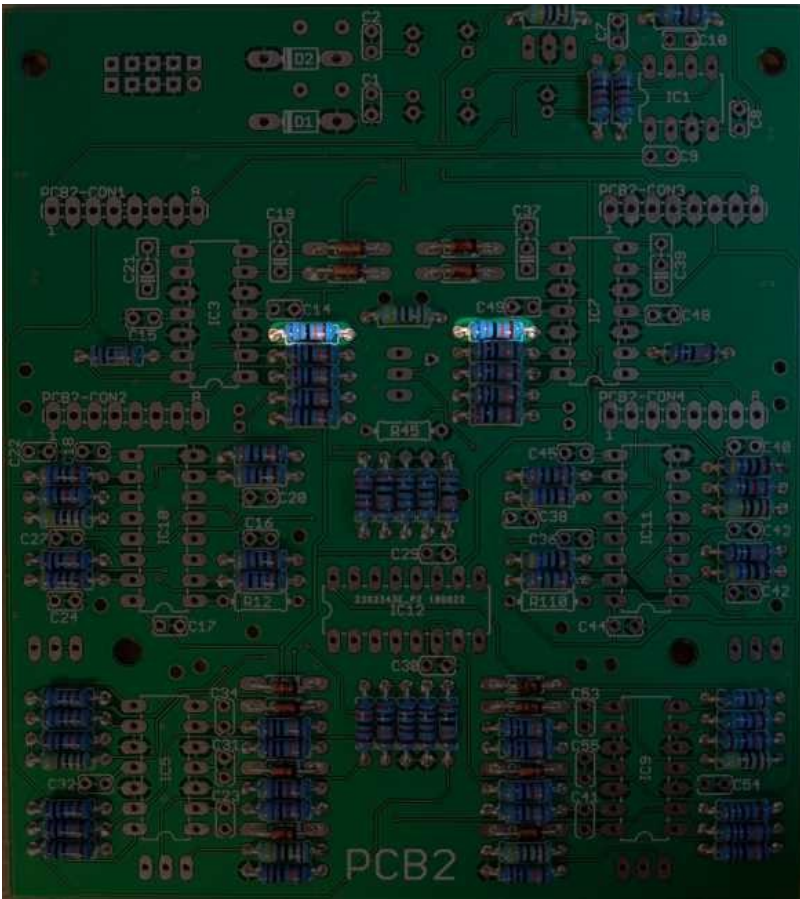

R19, R80 680K 2pcs

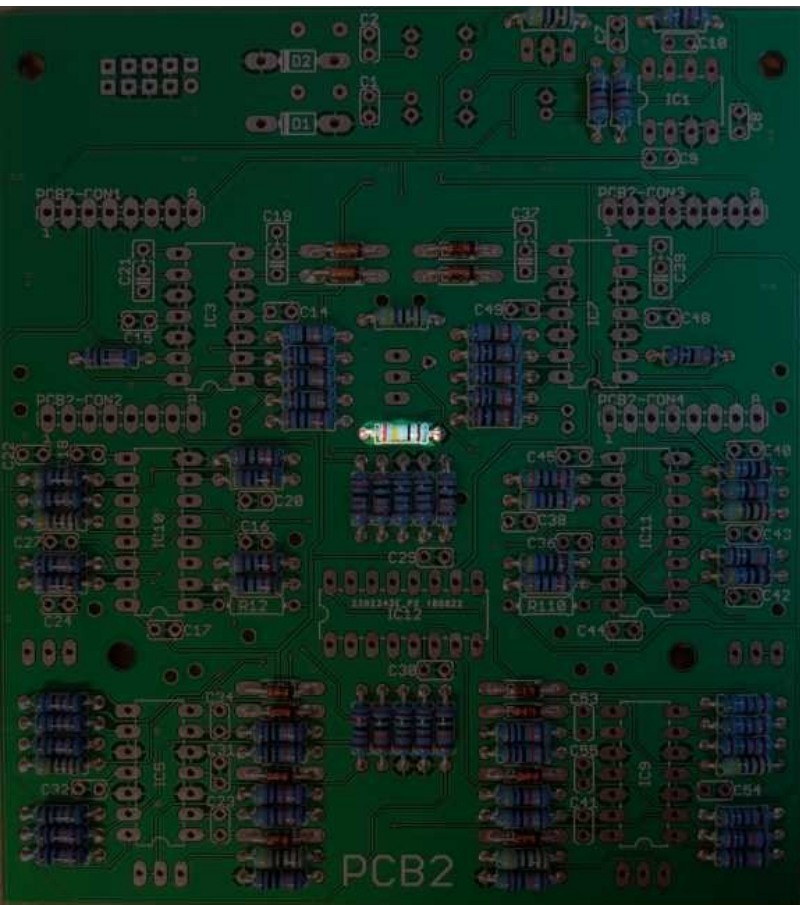

R45 249R 1pcs (240-270R)

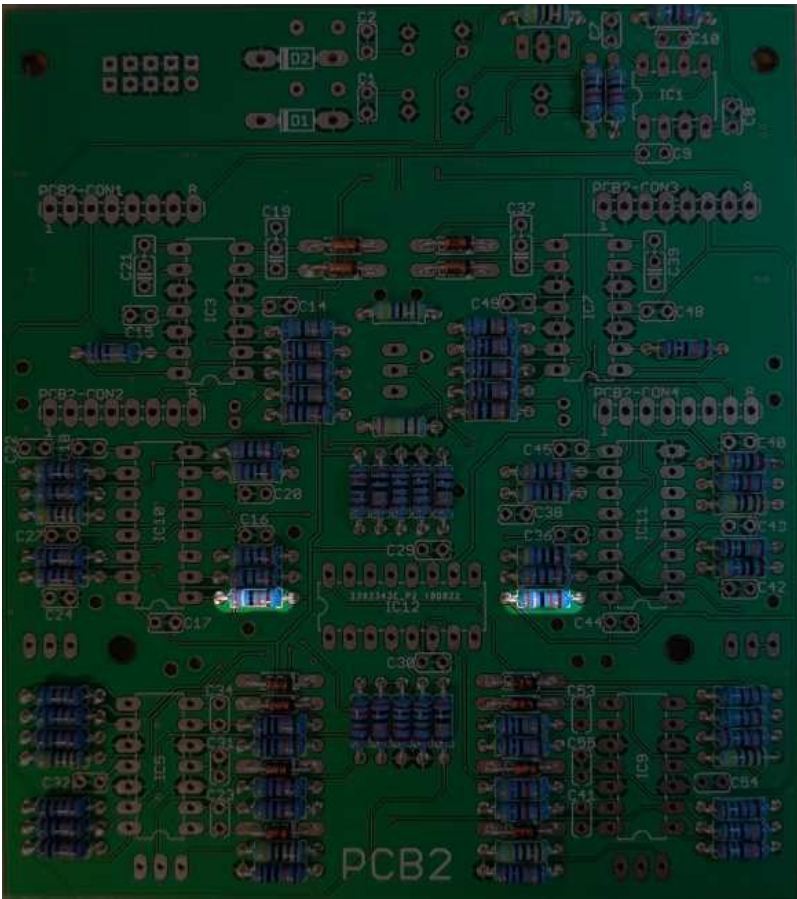

R12, R110 390K 2pcs

Step 3

Solder power polarity protection diodes. Diodes are sensitive to mounting direction, make sure the stripe on the diode match the stripe on the silkscreen.

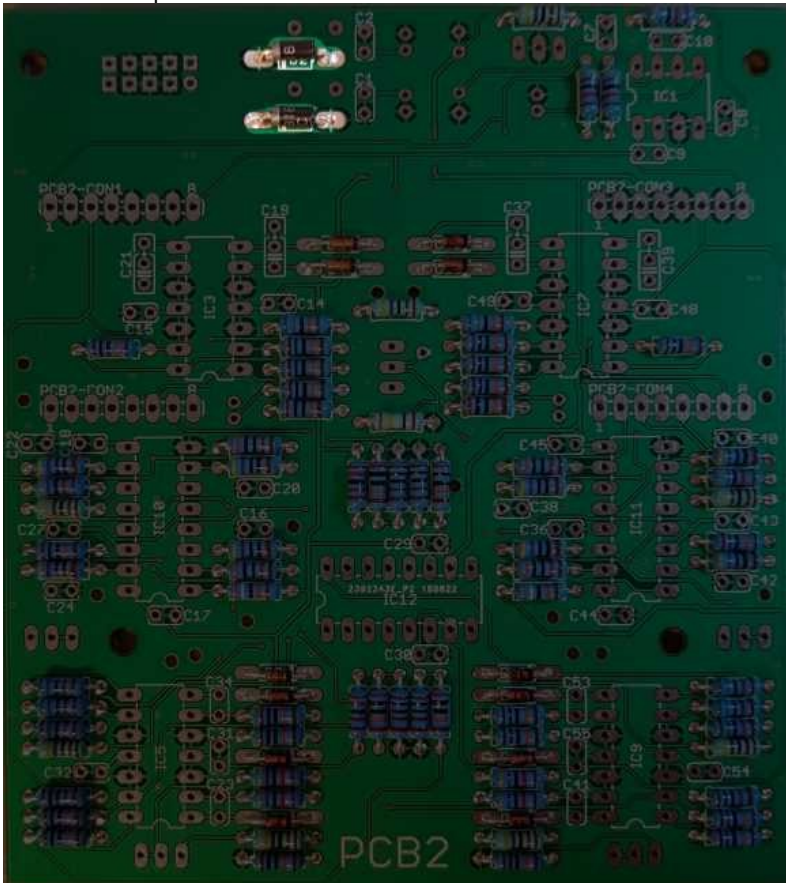

D1, D2 1N5818 2pcs

Step 4

Solder IC sockets. Match the IC sockets indent (marking pin 1 side) with the silk screens. If you feel the least uncertain on the IC direction, please search the web for IC orientation. IC's will be mounted later. Consider doing the capacitors in step 5 before this step if the IC sockets build more height than the capacitors which they often but not always do. Especially the 100nF capacitors.

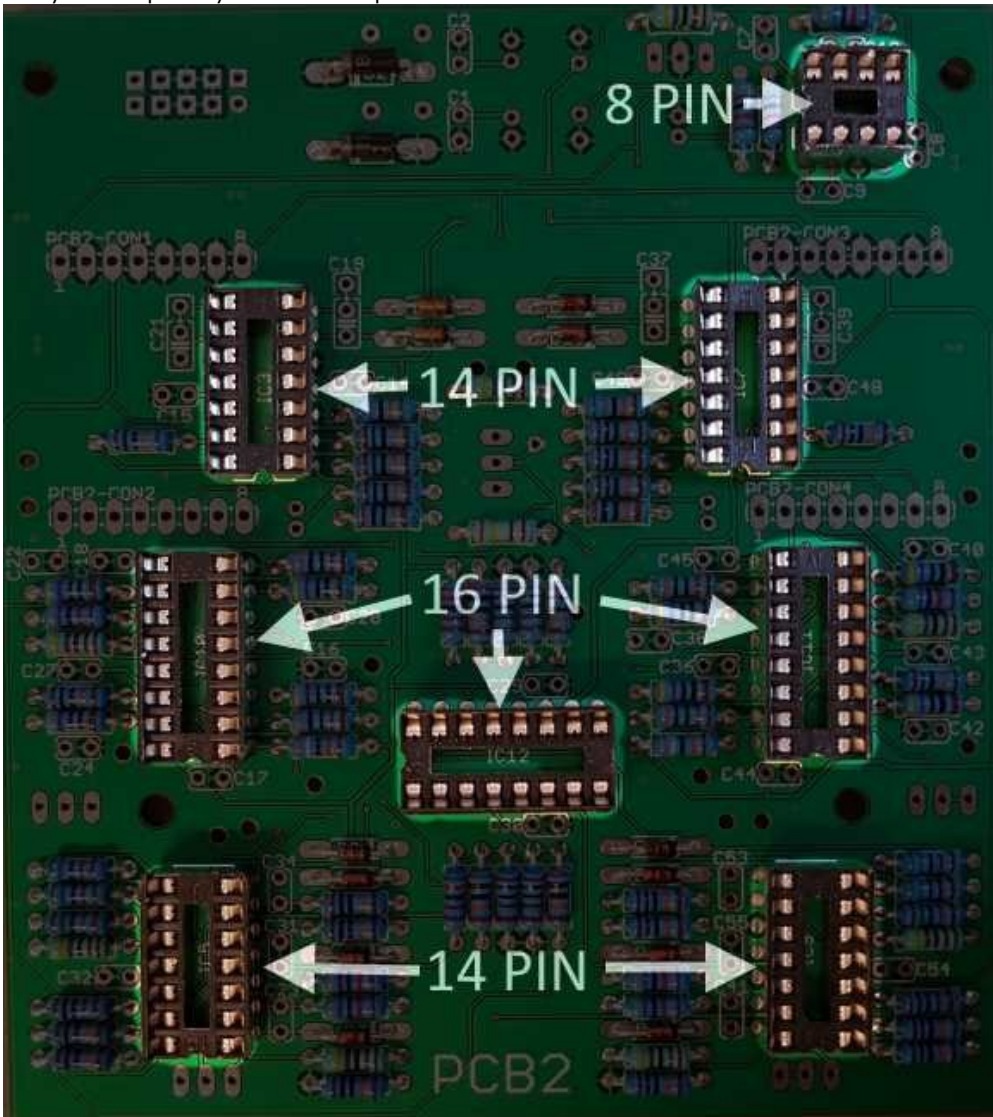

IC1 8 pin DIP socket (DIP-8) 1pcs

IC3, IC5, IC7, IC9 14 pin DIP sockets (DIP-14) 4pcs

IC10, IC11, IC12 16 pin DIP sockets (DIP-16) 3pcs

Step 5

Solder ceramic capacitors. Ceramic capacitors are not sensitive to mounting direction.

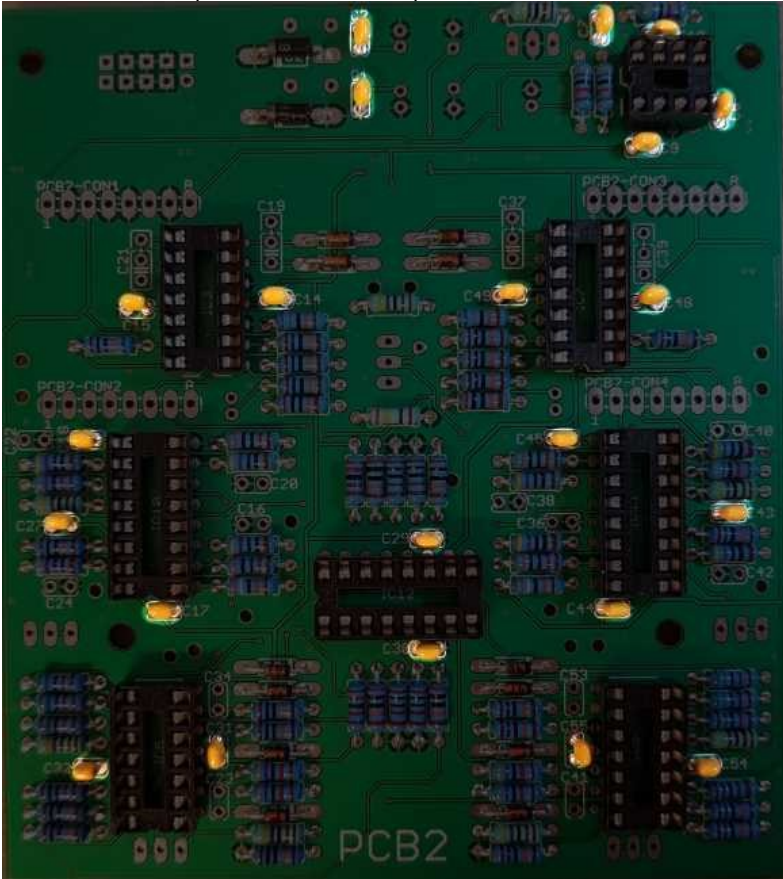

C1, C2, C7, C8, C9, C10, C14, C15, C17, C18, C27, C29, C30, C31, C32, C43, C44, C45, C48, C49, C54, C55
100nF 22pcs

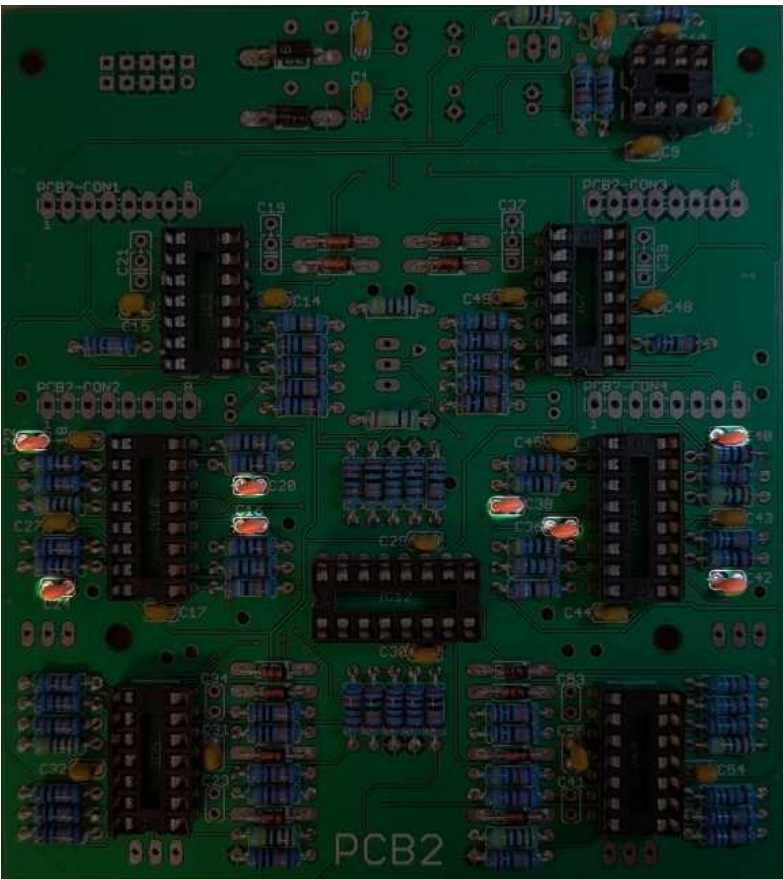

C16, C20, C22, C24, C36, C38, C40, C42 560pF 8pcs

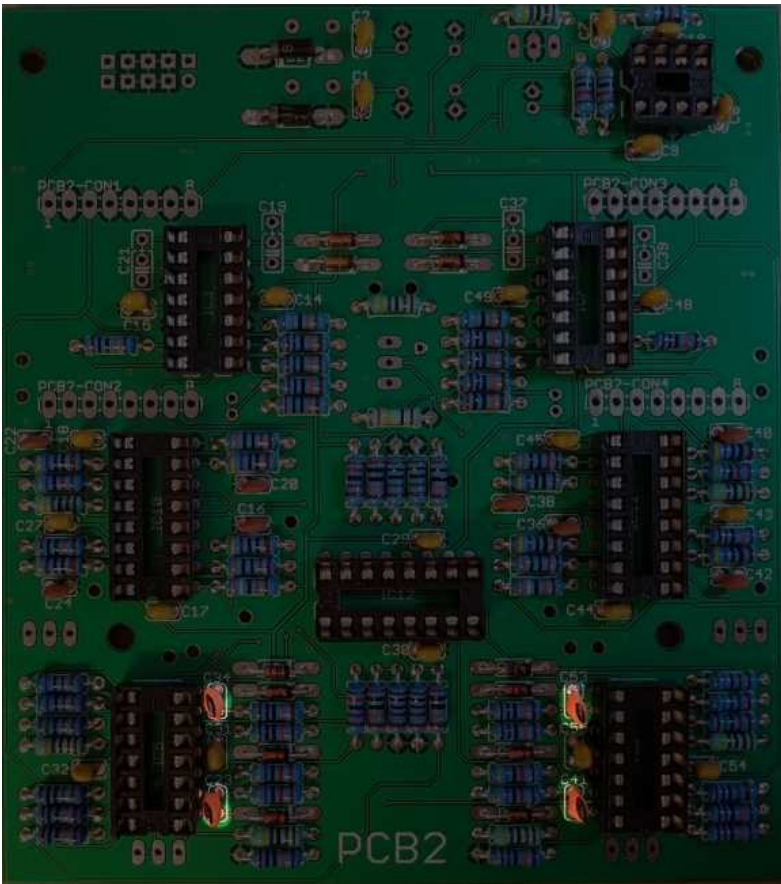

C23, C34, C41, C53 15pF 4pcs

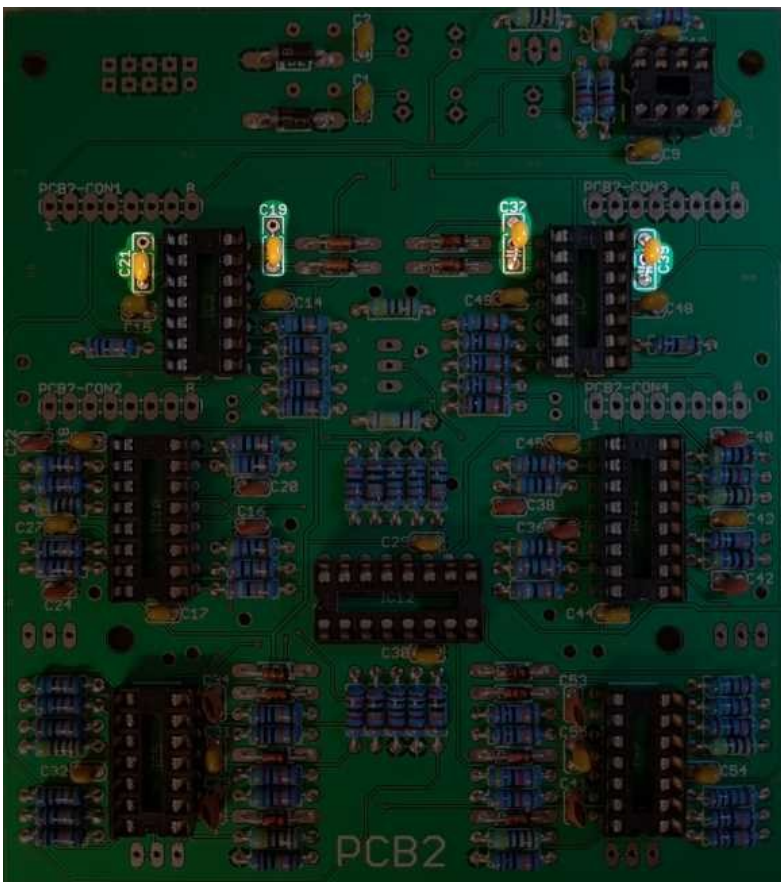

C19, C21, C37, C39 220pF 4pcs

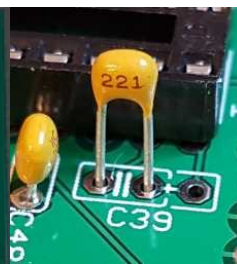

Capacitors with 2.5-2.54mm pin pitch are supposed to be mounted in the pads/holes shown above. On each side of the two stripes.

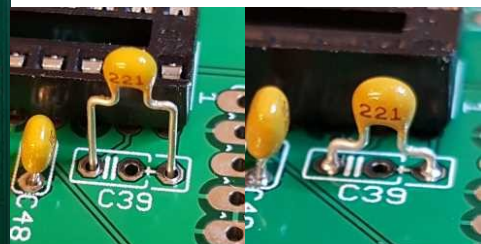

Capacitors with 5.0-5.08mm pin pitch are supposed to be mounted in the outer pads/holes. Make sure the pins don't touch the middle pad.

Now it's time to flip PCB2 to the other side.

Step 6

Solder electrolytic capacitors. Electrolytic capacitors are sensitive to mounting direction. Put the long pin in the hole marked with a + (anode) on the silkscreen. If the electrolytic capacitor are taller than the trimmers it's a good idea to wait with them until after the trimmers are soldered in place, it's likely that the 100 μ F ones are taller.

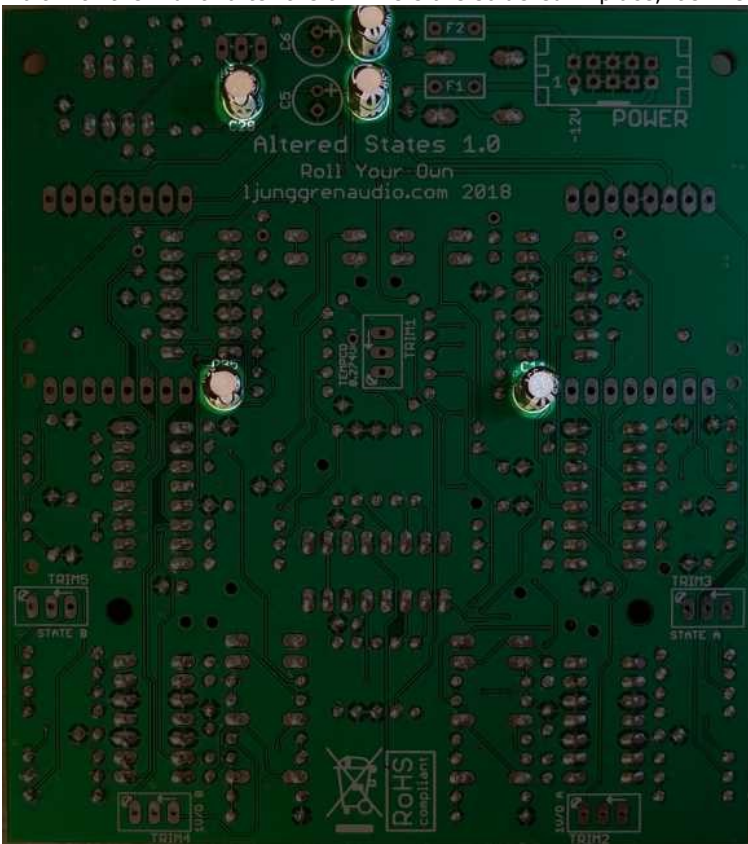

C3, C4, C11, C28, C35 10 μ F 5pcs

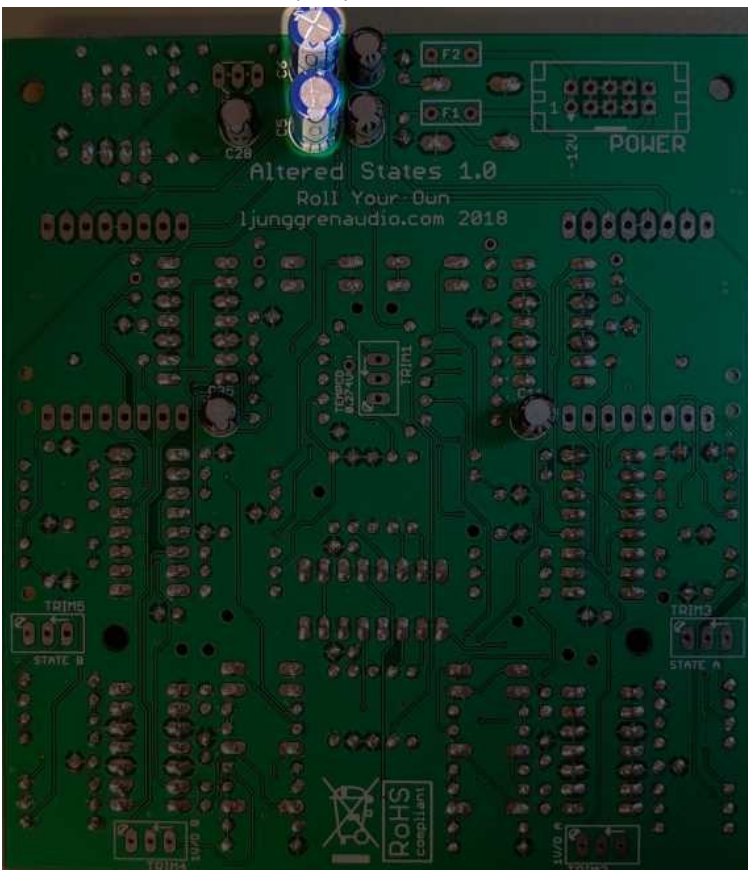

C5, C6 100 μ F 2pcs

Step 7

Solder the volt reference diode, they are sensitive to mounting direction. Match the curved side on the volt reference diode with the curved side in the silkscreen. They look similar to transistors but are high precision zener diodes.

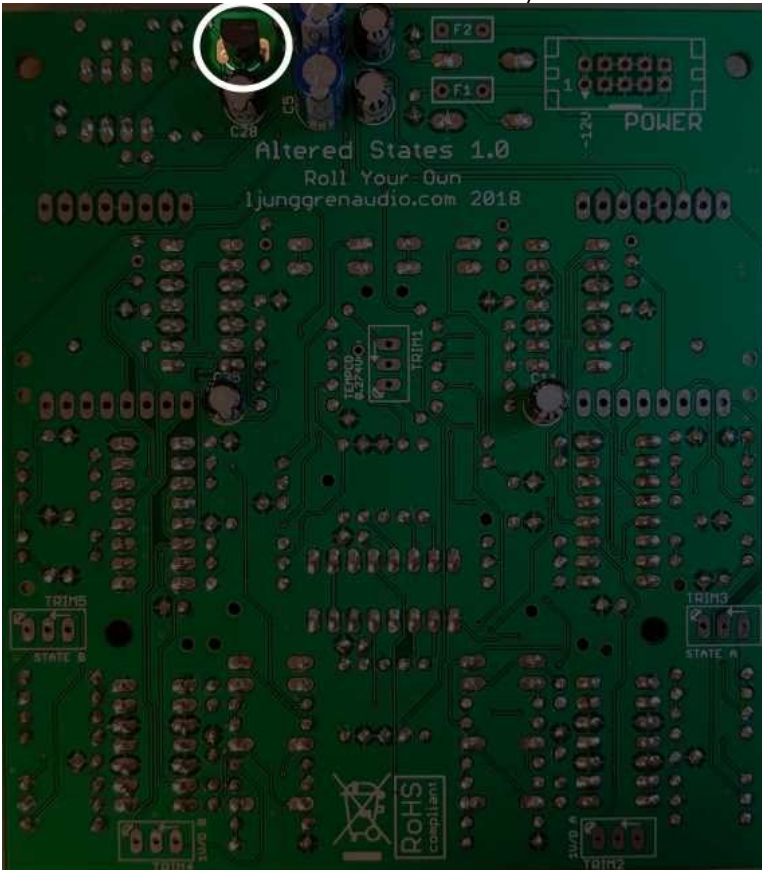

D3 LM4040 5V 1pcs

Step 8

Solder the power header. Make sure the key opening is oriented in the same way as in the picture below. It's easier to avoid bent pins if you attach the power cable in the header while you are soldering.

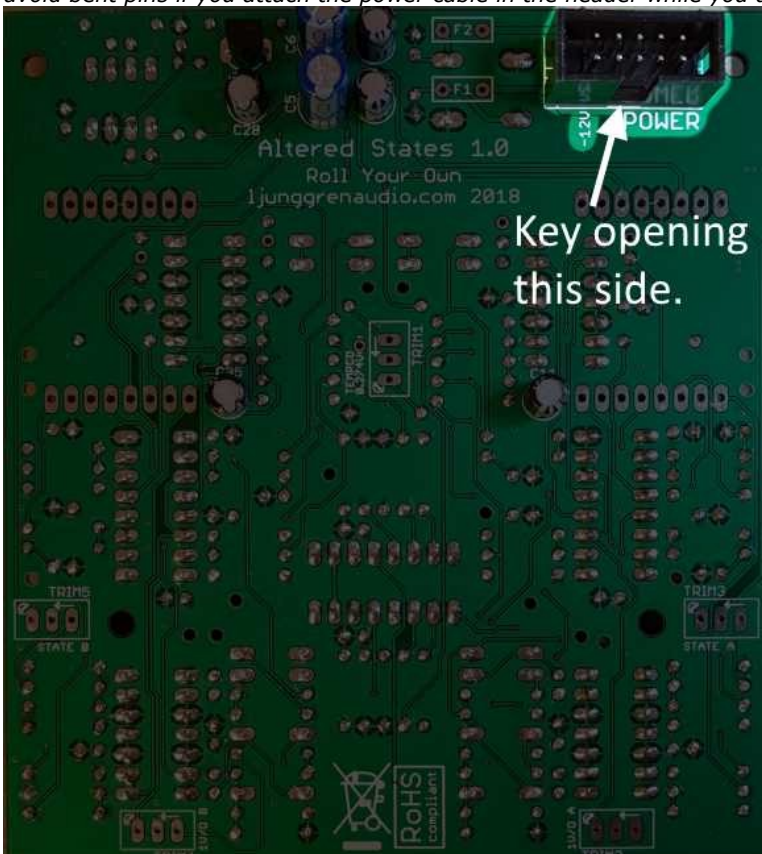

Step 9

Now it's time to solder trimmers. They are not sensitive to mounting direction.

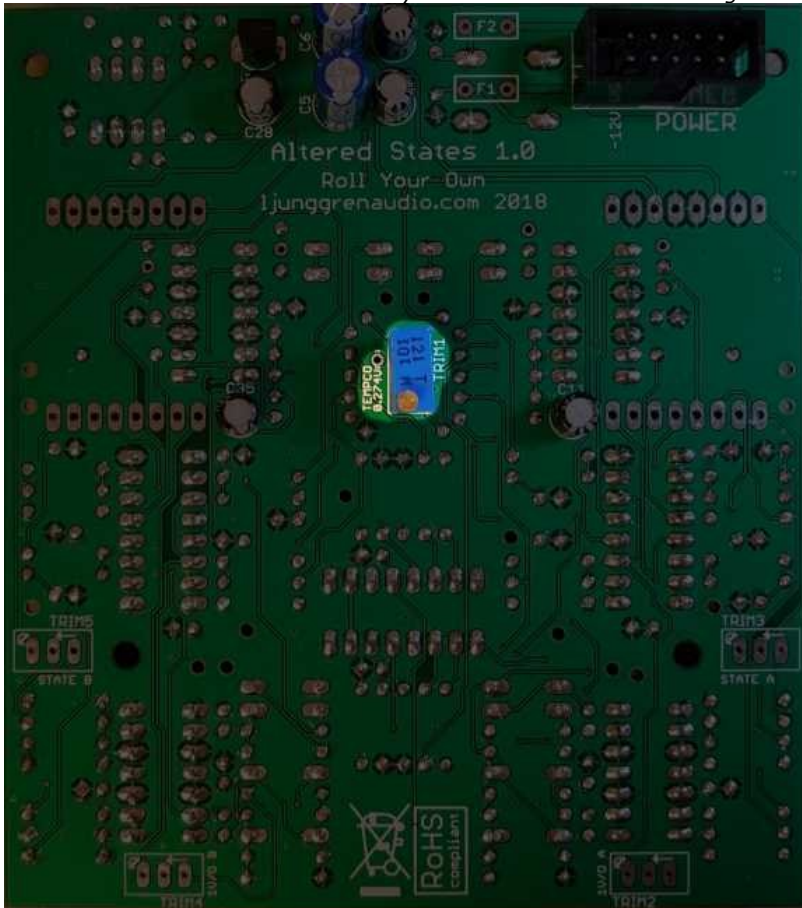

TRIM1 100R multi turn trimmer 1pcs

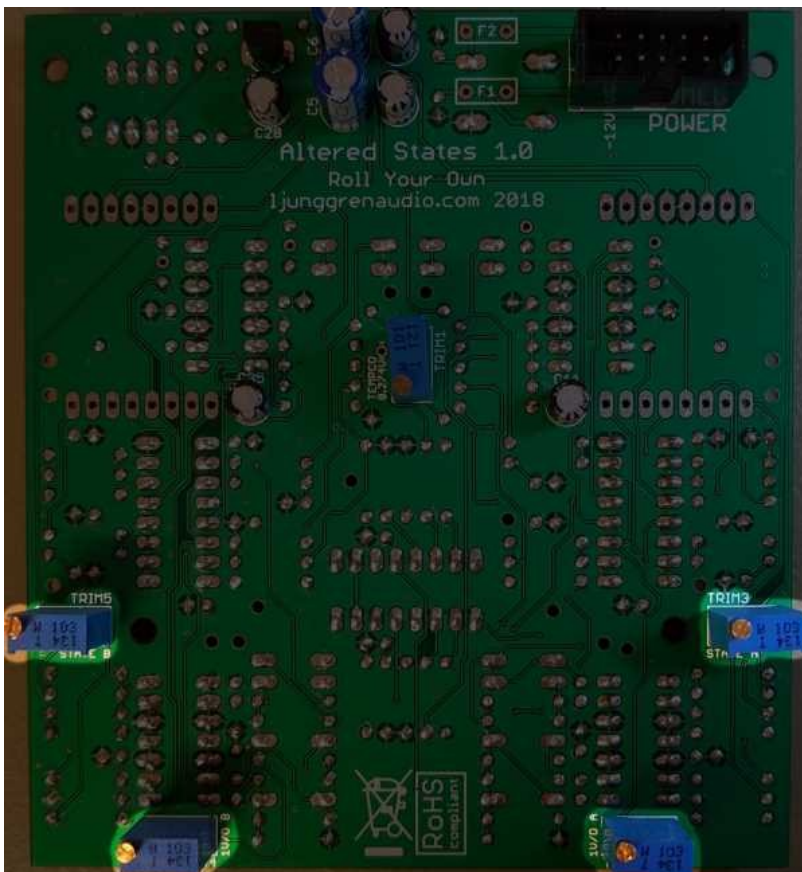

TRIM2, TRIM3, TRIM4, TRIM5 10k multi turn trimmer 4pcs

Step 10

Now we solder the auto resettable fuses in place. They are not sensitive to mounting direction.



F1, F2 PPTC 72V/0.25A

Step 11

Mount the spacers with the nuts on PCB2. Also put the pin & socket strips into each other. Place them between PCB1 and PCB2 in their respective places. Screw 2 of the screws in a diagonal orientation to fixate the pin & socket strips in place while soldering. Only solder the PCB2 side for now. Remove the screws again after soldering.

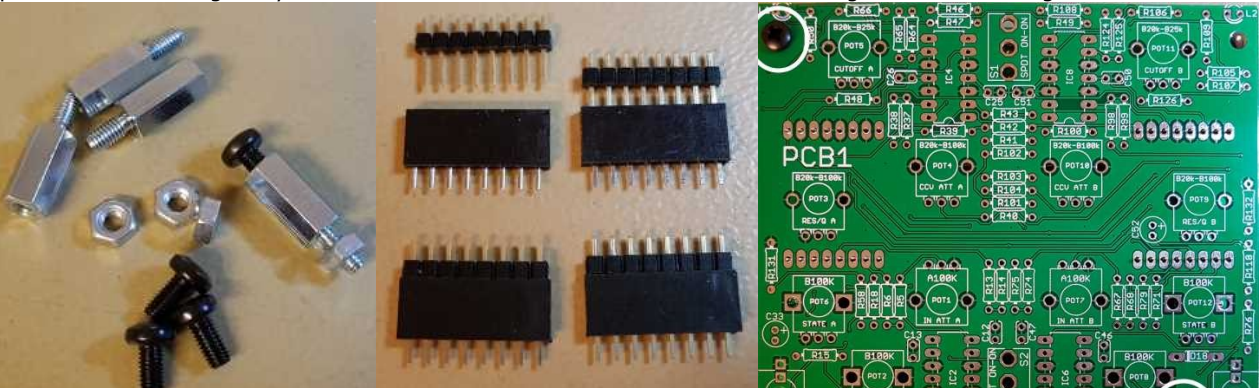

If you mount the spacers/standoffs like described it will be easier to screw in the screw when potentiometers and jacks are mounted.

But if you mount them the other way around it will be easier to remove and attach PCB2 without removing the front panel.

Step 12

Insert the ICs in the sockets. If you feel the least uncertain on the IC direction, please search the web for IC orientation.

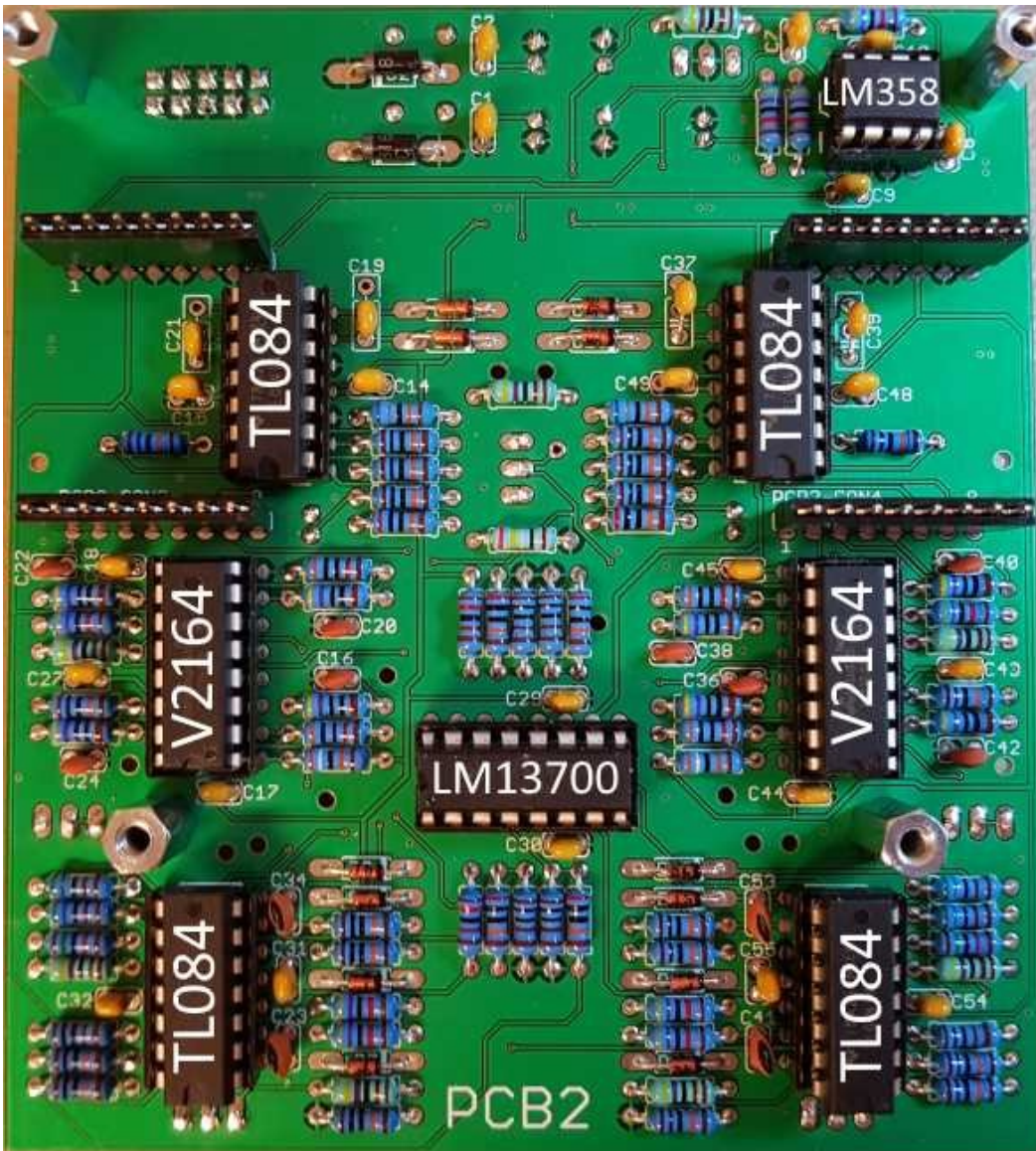

IC1 LM358 1pcs

IC3, IC5, IC7, IC9 TL074/TL084 4pcs

IC10, IC11 V2164 2pcs

IC12 LM13700 1pcs

Leave PCB2 on the side. Now it's time for PCB1.

Step 13

Solder small diodes. Diodes are sensitive to mounting direction, make sure the stripe on the diode match the stripe on the silkscreen.

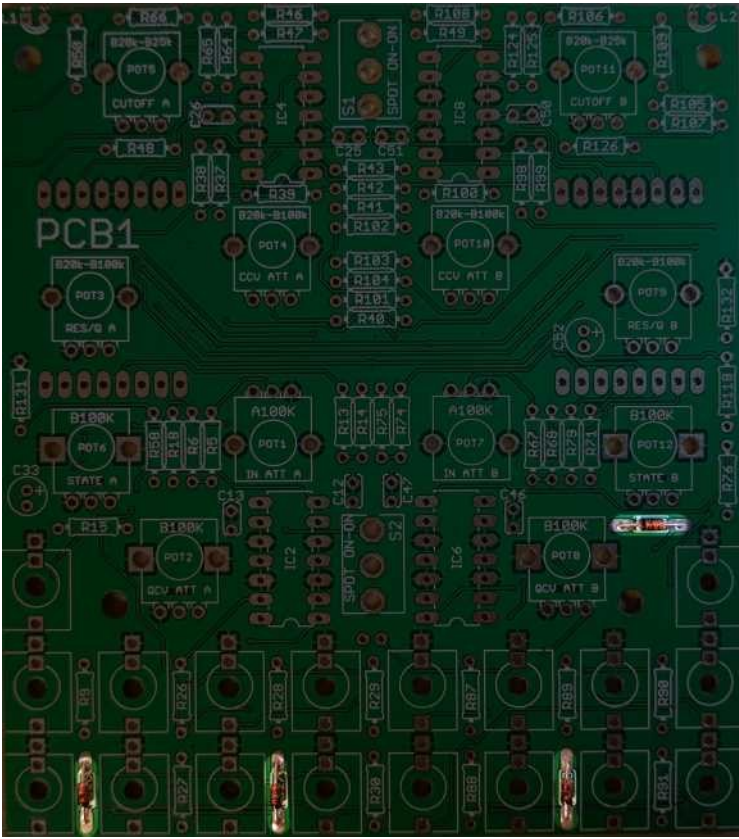

D16, D17, D18, D19 1N4148 4pcs

Step 14

Solder resistors. Resistors are not sensitive to mounting direction.

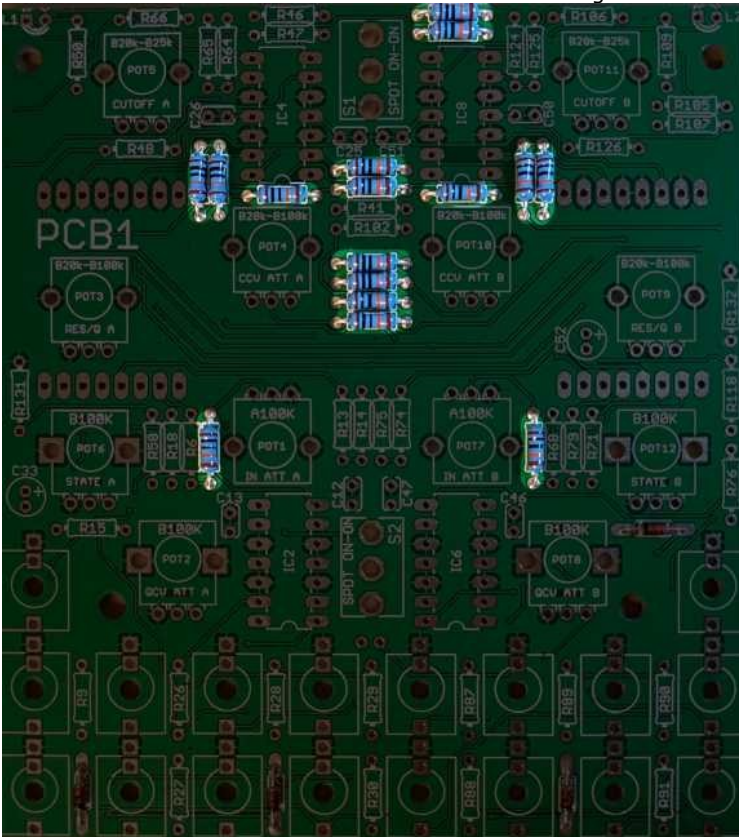

R5, R37, R38, R39, R40, R42, R43, R49, R67, R98, R99, R100, R101, R103, R104, R108 100k 16pcs

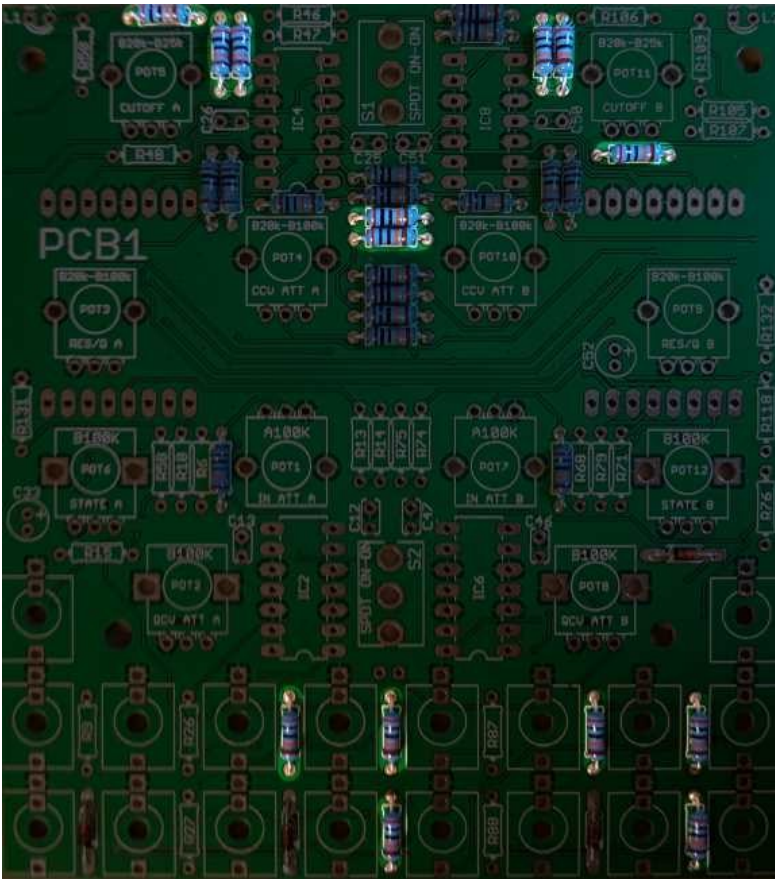

R28, R29, R30, R41, R64, R65, R66, R89, R90, R91, R102, R124, R125, R126 200k 14pcs

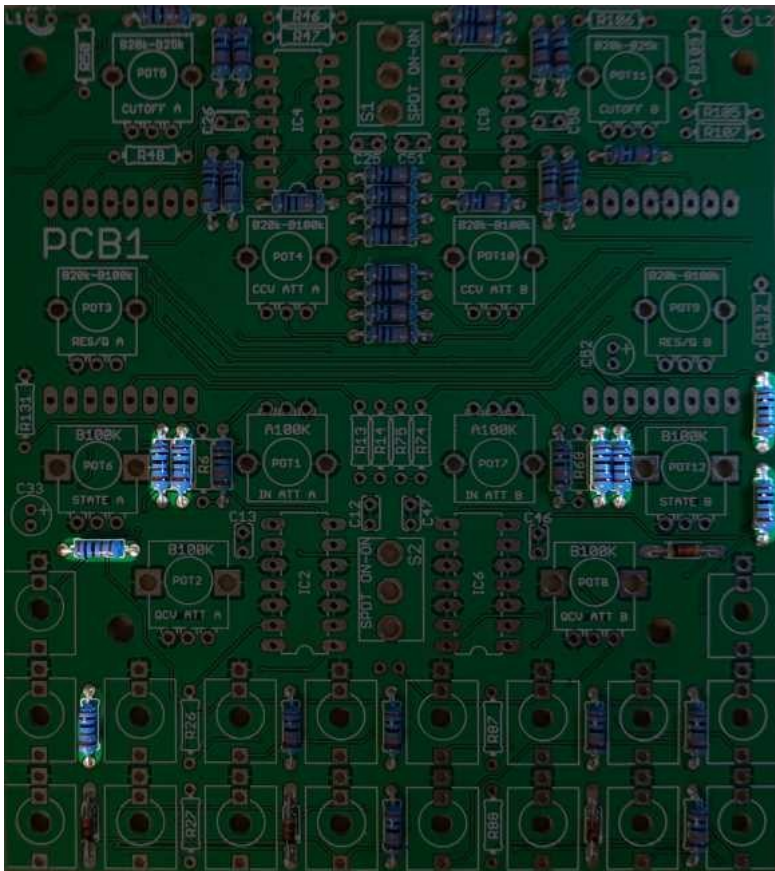

R9, R15, R18, R58, R71, R76, R79, R118 1k 8pcs

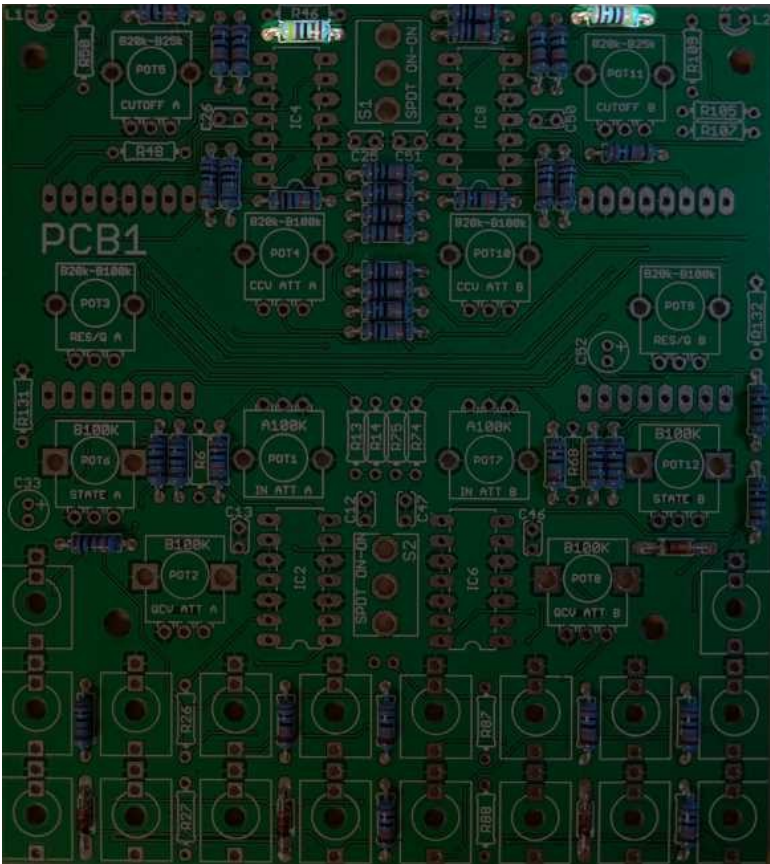

R47, R106 4.7k 2pcs

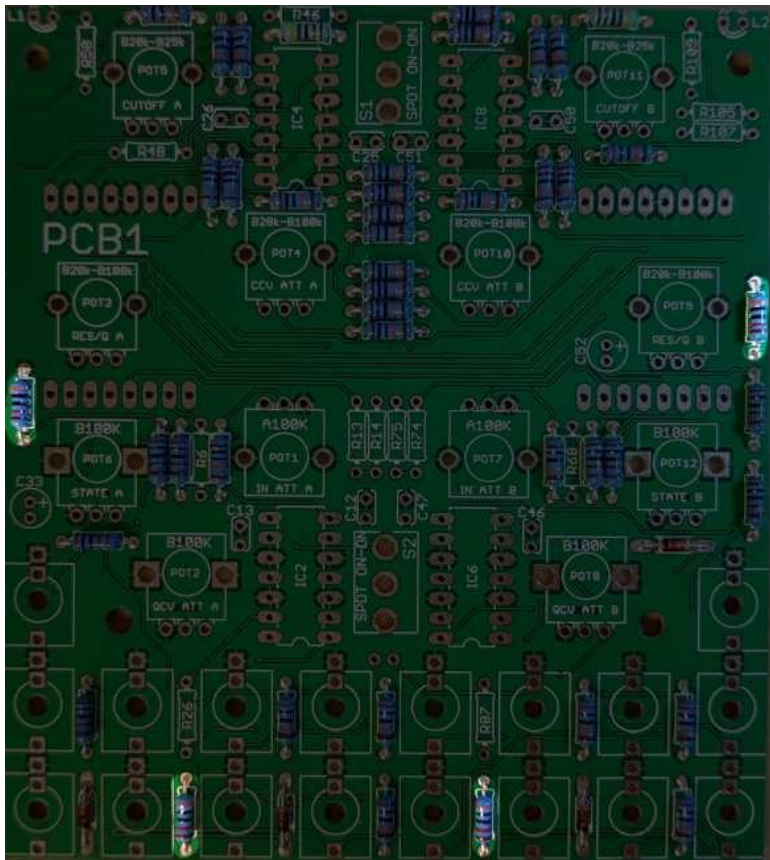

R27, R88, R131, R132 30k 4pcs

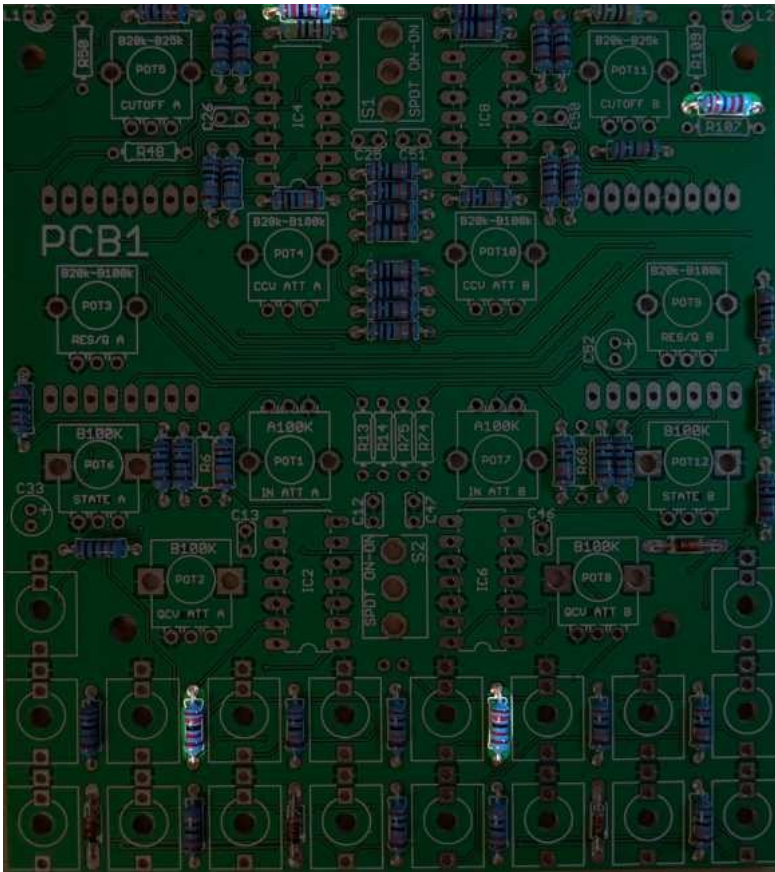

R26, R46, R87, R105 12k 4pcs

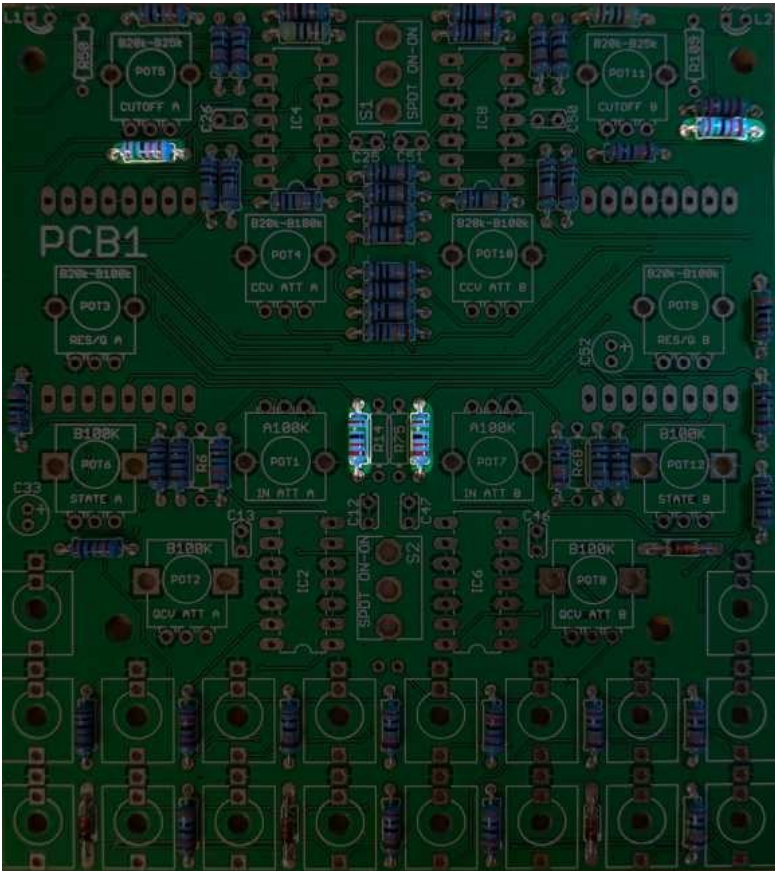

R13, R48, R74, R107 15k 4pcs

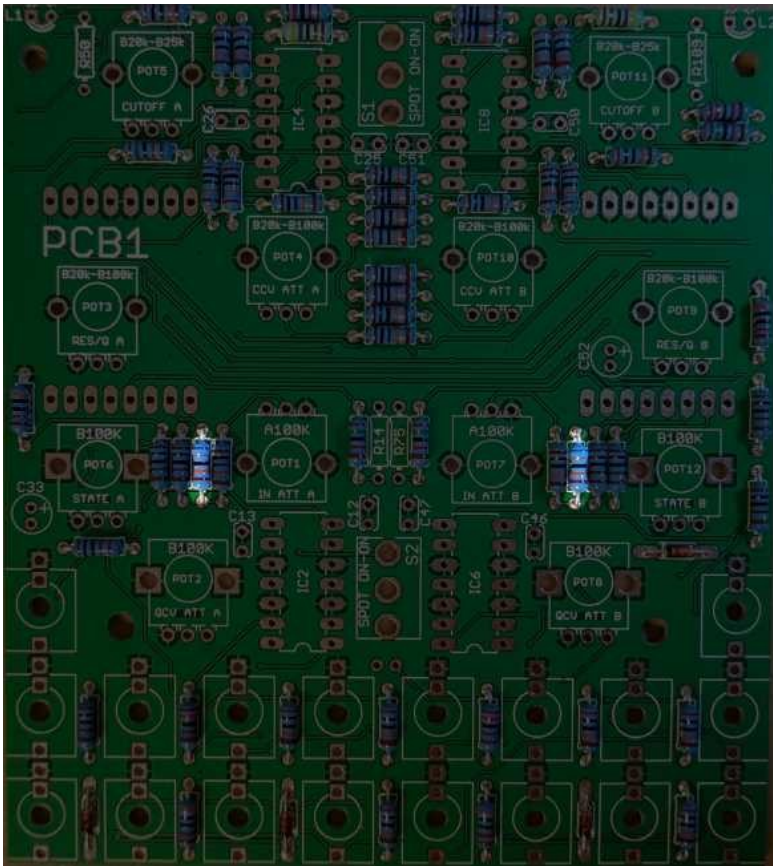

R6, R68 680k 2pcs

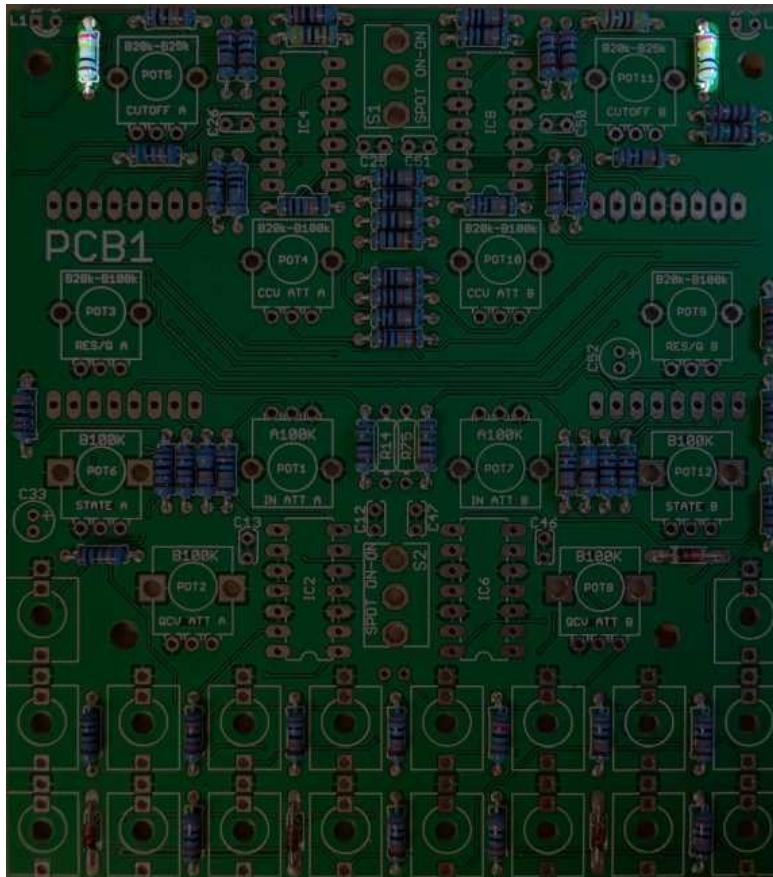

R50, R109 249R 2pcs (220-270R LED resistors)

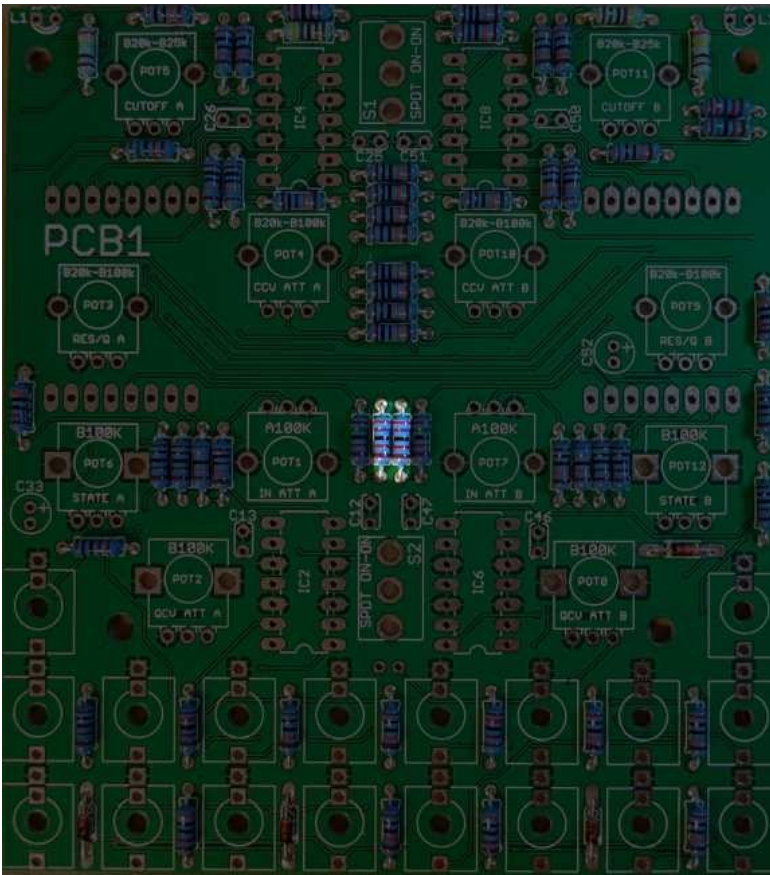

R14, R75 27k 2pcs

Step 15

Solder IC sockets. Match the IC sockets indent (marking pin 1 side) with the silk screens. If you feel the least uncertain on the IC direction, please search the web for IC orientation. IC's will be mounted later. Consider doing the capacitors in step 16 before this step if the IC sockets build more height than the capacitors which they often do.

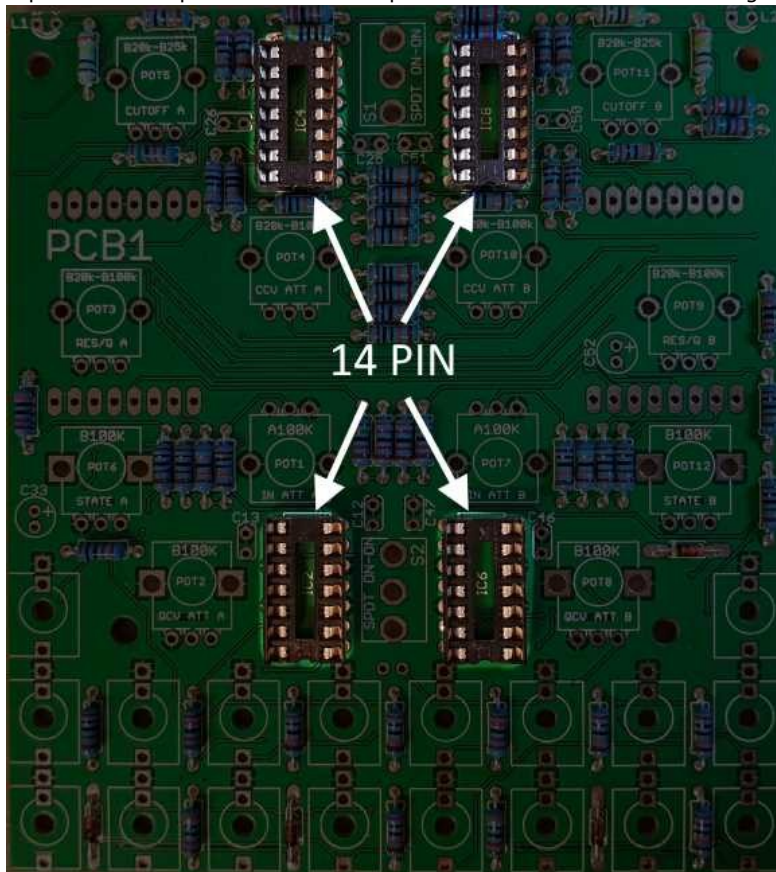

IC2, IC4, IC6, IC8 14 pin DIP sockets (DIP-14) 4pcs

Step 16

Solder ceramic capacitors. Ceramic capacitors are not sensitive to mounting direction.

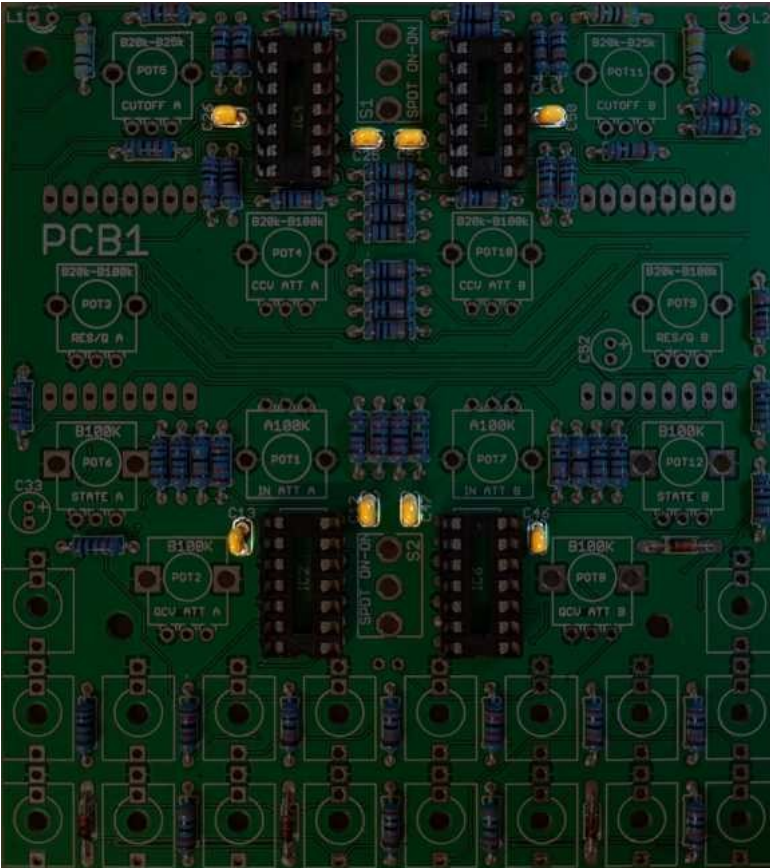

C12, C13, C25, C26, C46, C47, C50, C51 100nF 8pcs

Step 17

Solder electrolytic capacitors. Electrolytic capacitors are sensitive to mounting direction. Put the long pin in the hole marked with a + (anode) on the silkscreen.

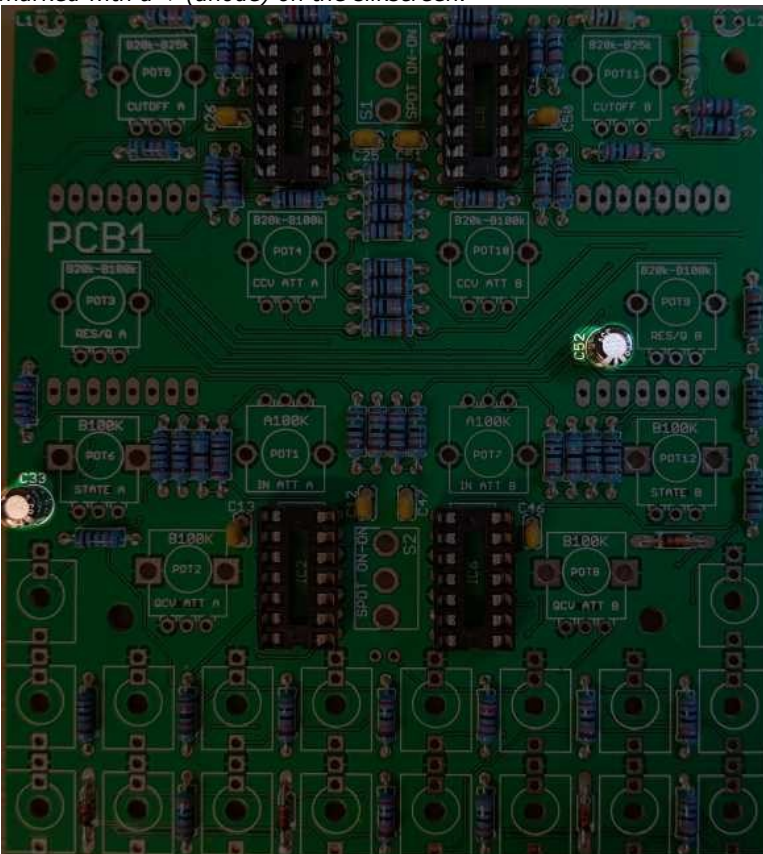

C33, C52 10µF 2pcs

Step 18

Now screw PCB1 & PCB2 back together with 2 screws diagonally to each other. Solder the pin & socket strips on PCB1 this time. Separate PCB1 & PCB2 again afterwards.

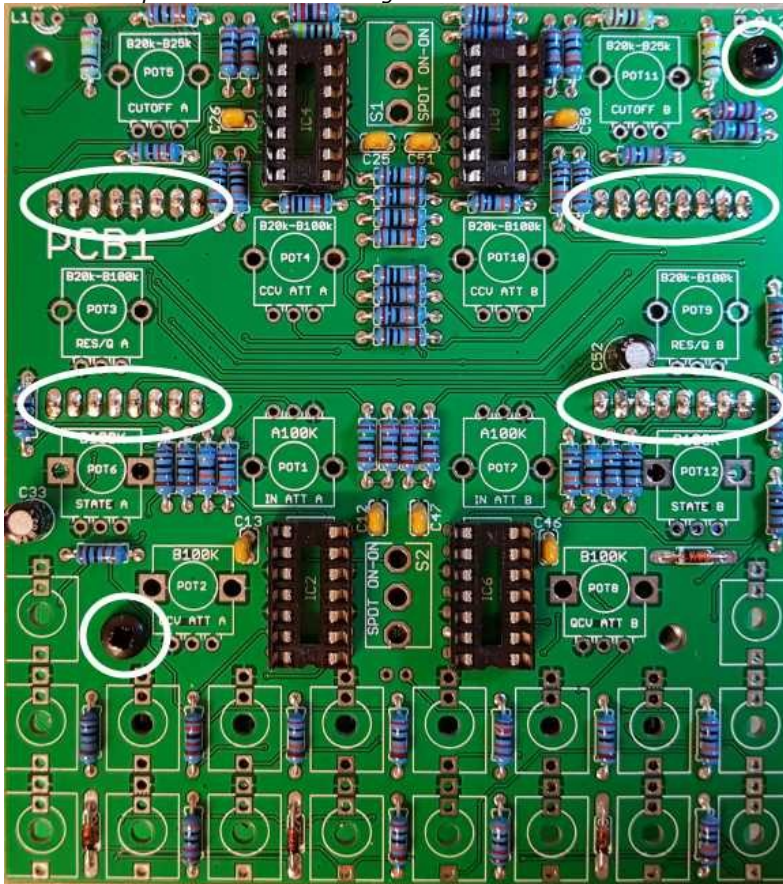

Step 19

Cut off the small metal anti rotation tab sticking out on the potentiometers if they have one. Use a cheap plier/nipper for this step, save your expensive ones for other tasks.



Normally we ship the kits with potentiometers from Song Huei. If you source the parts yourself you will probably have potentiometers from Alpha. Sometimes we ship potentiometers from Alpha in the kits too. Alpha put their name on the potentiometer for easy recognition.

If you have Song Huei potentiometers, mount 1 washer and 1 nut on each pot that will go under/below the frontplate. Make sure to tighten the nut. If you have Alpha potentiometers, don't put anything under/below the frontplate.

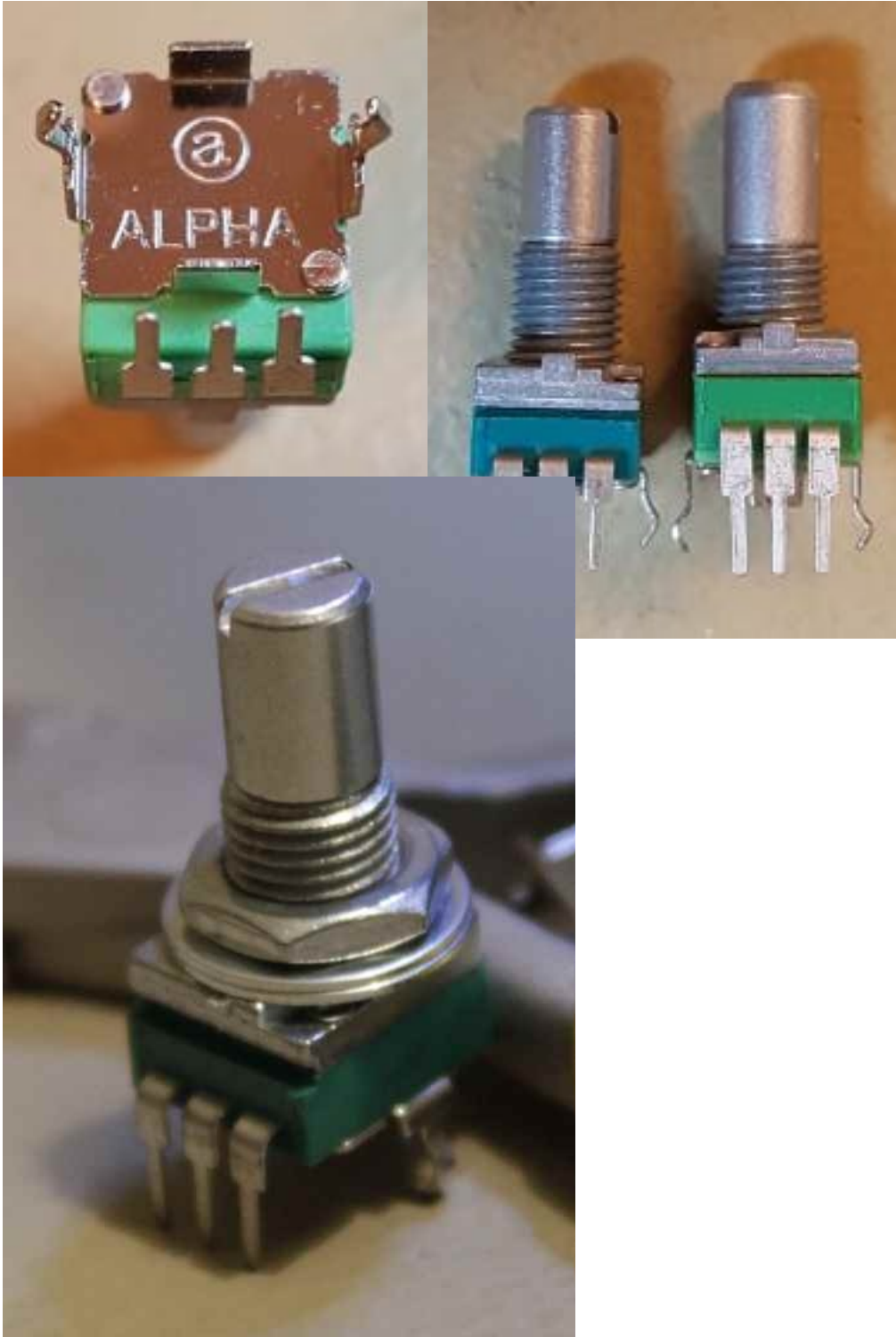

Step 20

Place potentiometers, jacks, LEDs and switches in their positions and mount the front panel. Solder them in place after the front panel is mounted. If you solder them before the front panel is mounted there is a risk of stress at the solder joints that can cause problems in the long run.

If you got 2 Alpha potentiometers and the rest from Song Huei in your kit, then mount the Alpha potentiometers in the top 2 positions for Cutoff A & B because those knobs are bigger and the Alpha potentiometer shafts is a little taller than the Song Huei ones. So the knobs don't get different heights from each other.

Remove the front panel again after soldering.

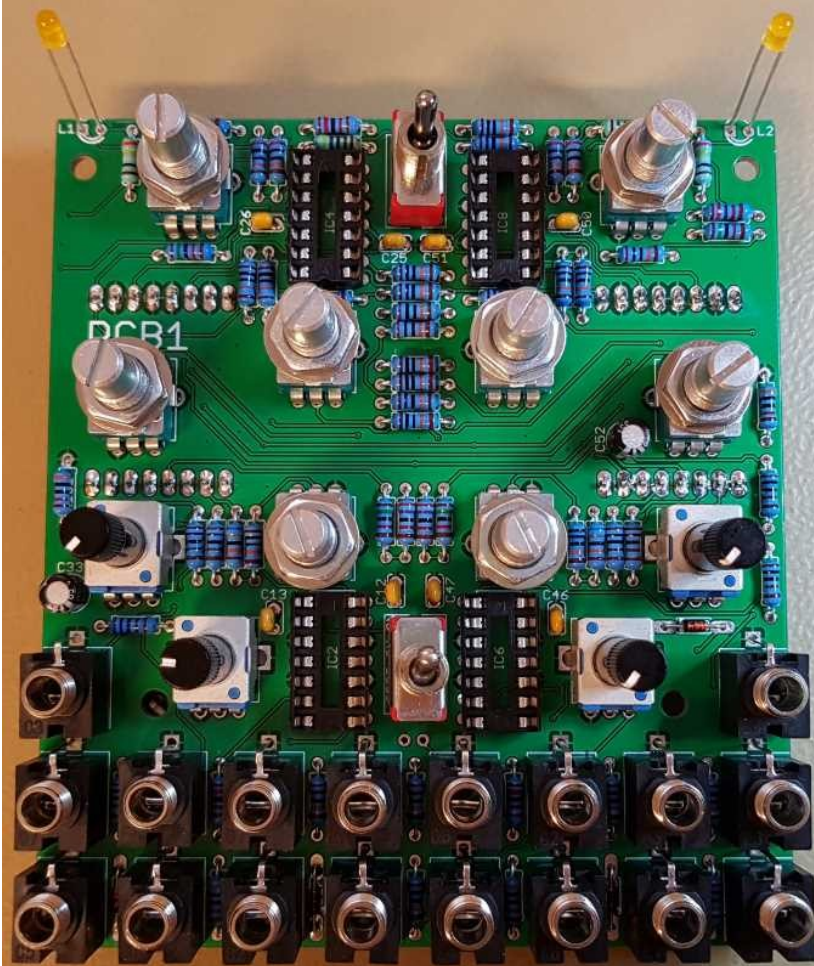

Step 21

If you want the CV input from Resonance A to be normalised onto the switch pin of Resonance B CV input then solder a jumper on the bottom/back side of PCB1. You can make the jumper from a cut off component pin from a previous step. This means that if you patch a CV to Resonance A and have no patch cable on Resonance B the CV will go equally to both inputs. If you patch a cable in Resonance B the connection will be broken.



Step 22

Insert the ICs in the sockets. If you feel the least uncertain on the IC direction, please search the web for IC orientation.

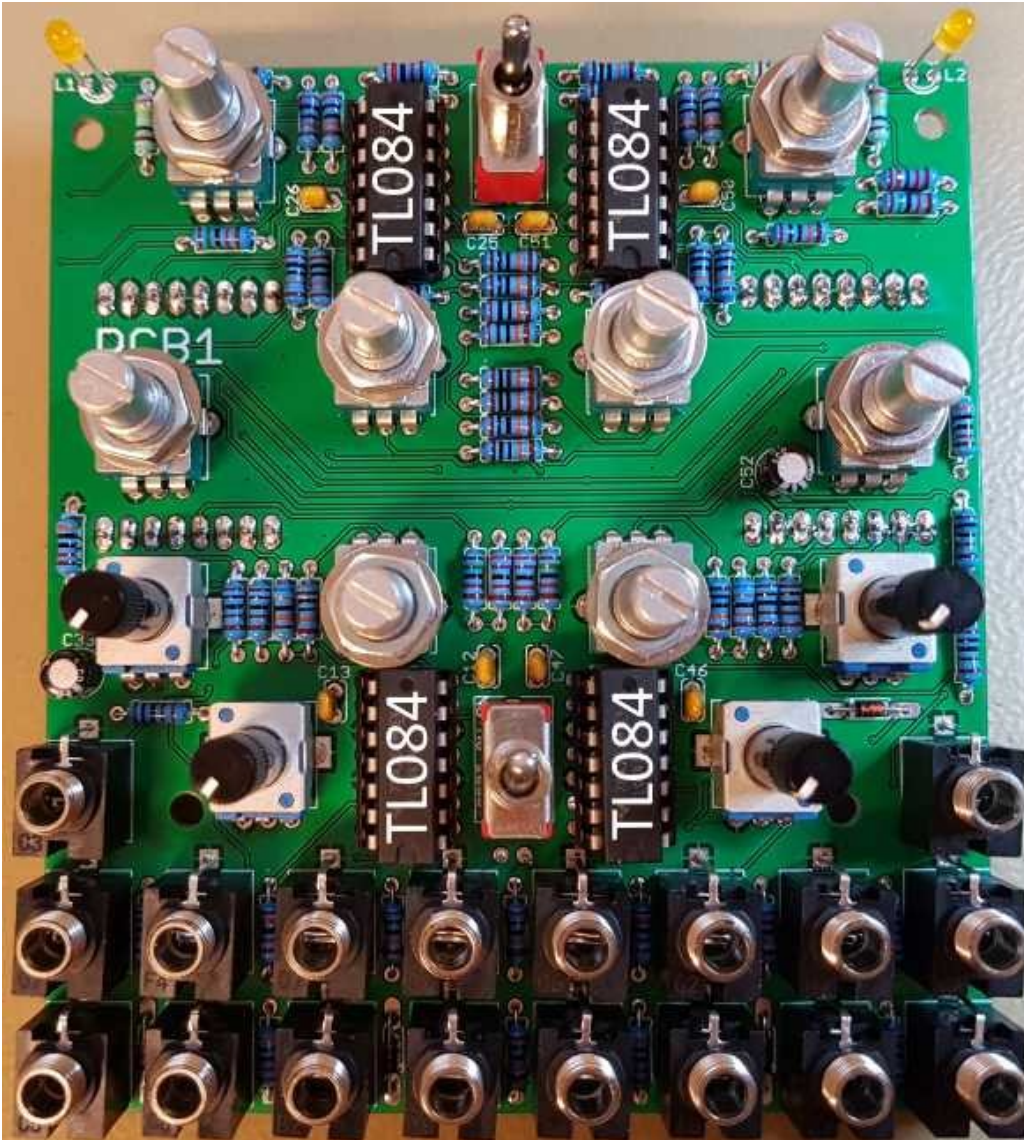

IC2, IC4, IC6, IC8 TL074/TL084 4pcs

Step 23

Mount PCB1 & PCB2 together for the last time and screw all 4 screws in place.

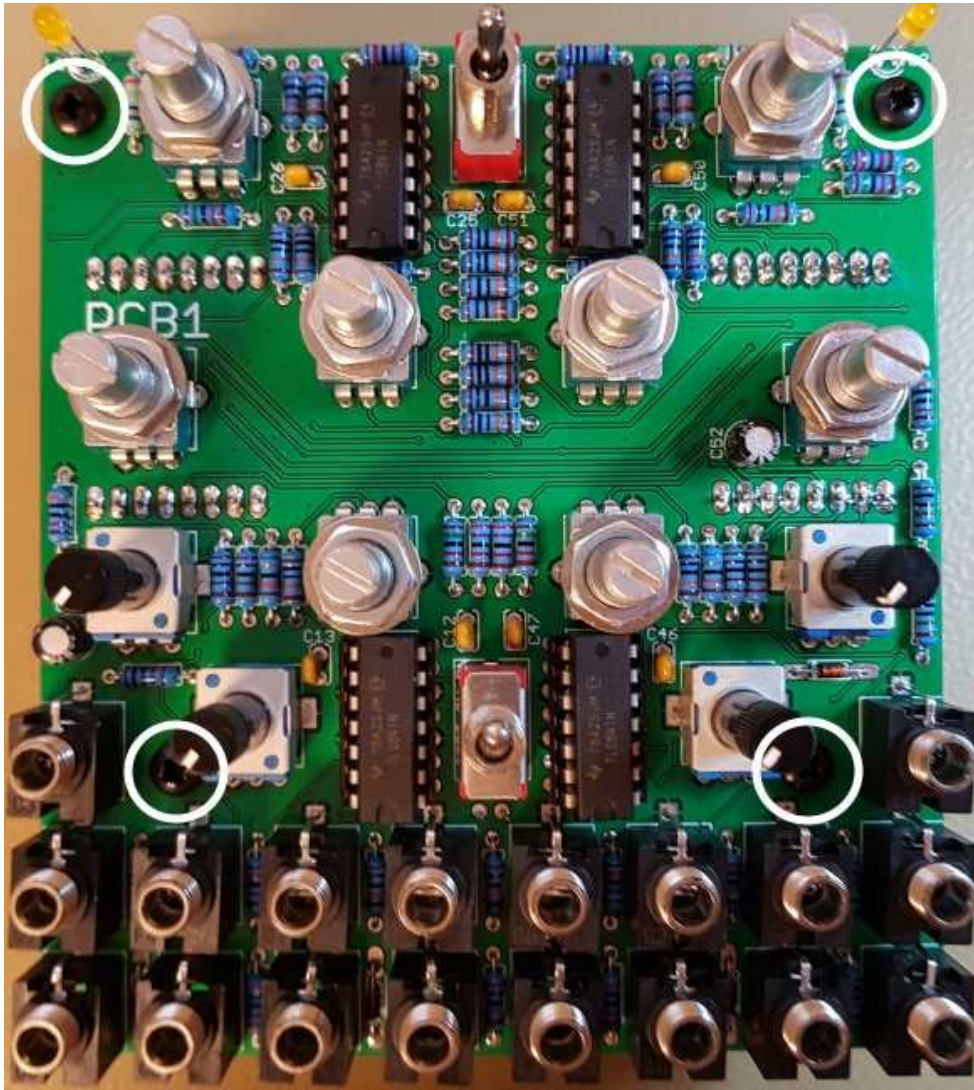

Step 24

Now mount the front plate for the last time and mount the knobs with help of the set screw in the back of the knobs. Make sure the knobs are turning freely all the way from counter clock wise to clock wise position. Attach the power cable with the stripe indicating pin 1 on the -12V side.



Cablibration

1) Measure with a multimeter in volt mode with the red probe on the unsoldered hole/pad where the arrow points in the image below. Put the black probe on a barrel of one of the jacks for ground. Turn TRIM1 until you read 0.274V, this is the voltage for the VCA on each V2164 that act as tempo.

2) Set the State knob (the knob that have a line coming from the jack SCV, State CV) on both the A & B side to fully counter clock wise (lowpass/left side). Put both Cutoff knobs fully counter clock wise too (left side) so the cutoff of LP is closed and the HP is open at the same time. Patch a sound to the input.

Listen to the state output of each filter side. Turn TRIM3 for side A and TRIM5 for side B until the sound goes quiet. There will be one quiet position and if you turn towards either direction from that position the HP will start to bleed thru with higher volume the further away from the quiet position.

3) If you want the filters to track over at least 5 octaves you need to calibrate the 1 volt / octave trimmers. The simplest way is to use a needle style chromatic tuner. Turn the resonance up to self oscillation on each filter side and measure the corresponding LP, BP or HP out with the tuner.

Make your 1 volt / octave source such as a MIDI interface or Quantizer that you will use with the module to put out 0V and 5V sequentially switching back and forth with a couple of seconds on each step. Patch this signal to the corresponding 1V/O input. Select a cutoff so your tuner can read both the tone coming at 0V and 5V CV in the bottom 1/3 of the cutoff knob range.

Turn the trimmer (TRIM2 for side A and TRIM4 for side B) and watch the needle and note. You want to make both tones to be close to the same seminote 5 octaves from each other with the needle standing in the same position, you don't need the needle to be exactly at the clean seminote center position, the calibration will work any way. When you turn the trimmer one way the gap between the seminotes will grow and in the other direction the gap will shrink.

Now the calibration is finished and you can use the module and tune the 1V/O CV/Cutoff knob to a clean seminote and when you change the 1V/O signal to another note the tracking will work as intended over at least the range you used when calibrating.

