

Ljunggren Audio Roll Your Own XNOR/XOR/NOT

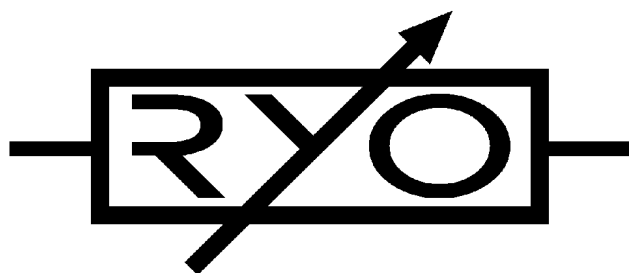

PCB Version: Discrete X(N)OR/NOT 1.0

Bills Of Material

Type	Qty	Value	Parts	Note
Pin strip	2	10x1 pin	CON1, CON2	Angled 90 deg.
Resistor	1	10R	R1	
Resistor	5	249R	R14, R21, R40, R46, R56	
Resistor	8	15k	R7, R9, R16, R24, R33, R35, R42, R51	
Resistor	8	1.2k	R10, R13, R26, R27, R36, R39, R52, R53	
Resistor	14	220k	R3, R8, R12, R17, R19, R23, R29, R34, R38, R43, R45, R47, R50, R55	
Resistor	20	100k	R2, R4, R5, R6, R11, R15, R18, R20, R22, R25, R28, R30, R31, R32, R37, R41, R44, R48, R49, R54	
Capacitor	6	100nF	C2, C3, C4, C5, C6, C7	X7R 2.5mm
Electrolytic	1	10uF	C1	2mm pin pitch, 5mm dia, 5mm height
Transistor	27	BC547B	Q1, Q2, Q3, Q4, Q5, Q6, Q8, Q9, Q10, Q11, Q12, Q13, Q14, Q15, Q16, Q17, Q18, Q19, Q20, Q22, Q23, Q24, Q25, Q26, Q27, Q28, Q29	NPN
Transistor	2	BC557B	Q7, Q21	PNP
Jack	9	3.5mm	IN1, IN2, IN3, IN4, IN5, OUT1, OUT2, OUT3, OUT4	J301M-12 / Thonkiconn / Inline
Power header	1	5x2pin boxed	POWER	Boxed header
Diode	1	1N5818	D1	Or SB130, power polarity protection.
LED	5	green	L1, L2, L5, L6, L8	3mm
LED	4	orange	L3, L4, L7, L9	3mm

The green LEDs use resistors R14, R21, R40, R46 and R56.

The orange LEDs use resistors R13, R27, R39 and R53.

Faceplate	PCB material, black, 2mm.
PCB	One PCB split into two with v-cut.
Mounting screws	Two black pozidriv M3x6 screws.
Power cable	IDC 16pin - 10pin

[Schematics can be found here.](#)

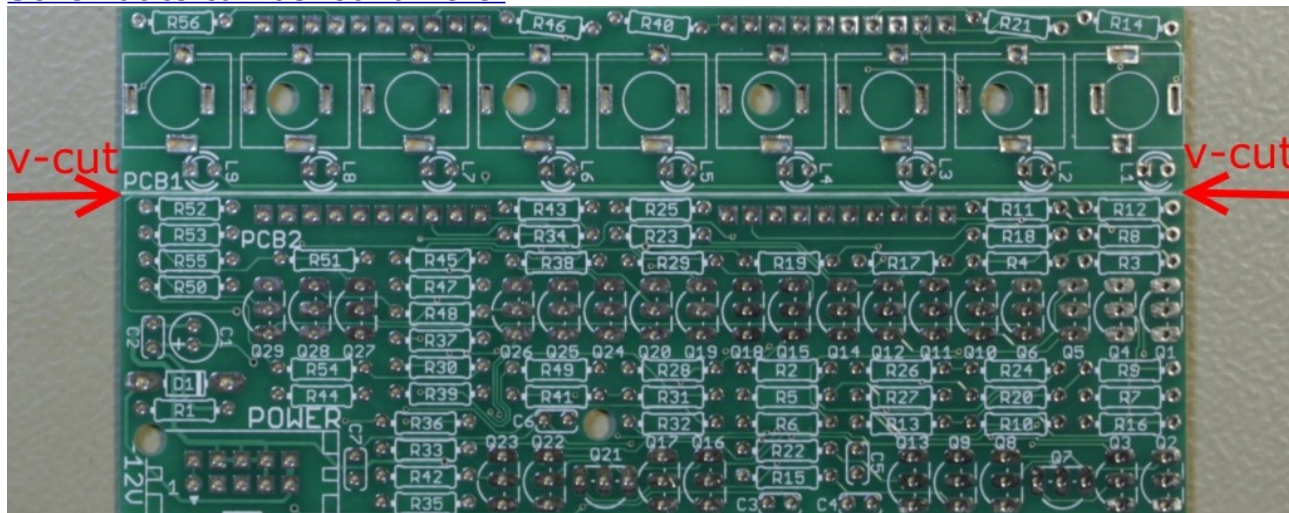

Empty PCB.

Assembly instructions

Start with breaking the PCB into two parts with your hands along the V-Cut. The picture shows a Trig Xpander but it works the same way.

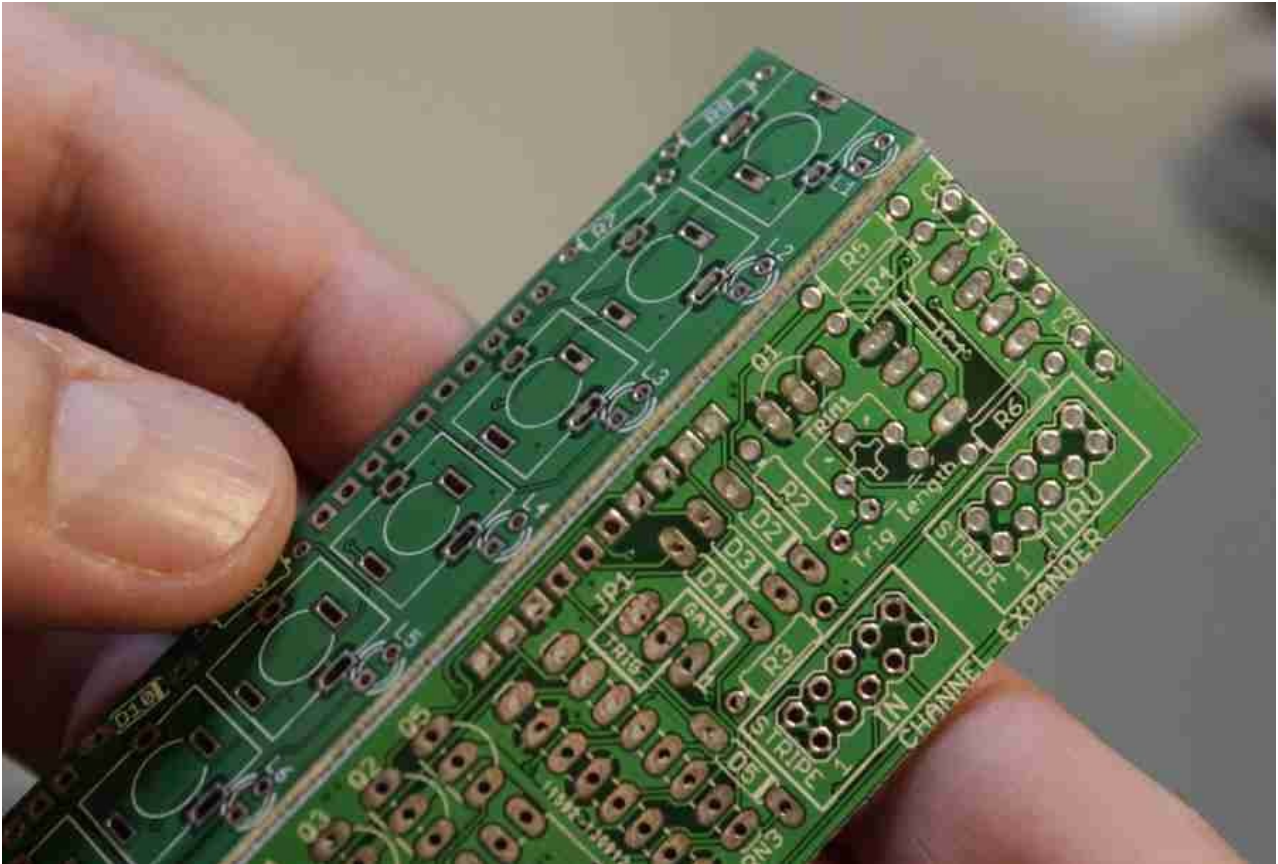

You should end up with this.

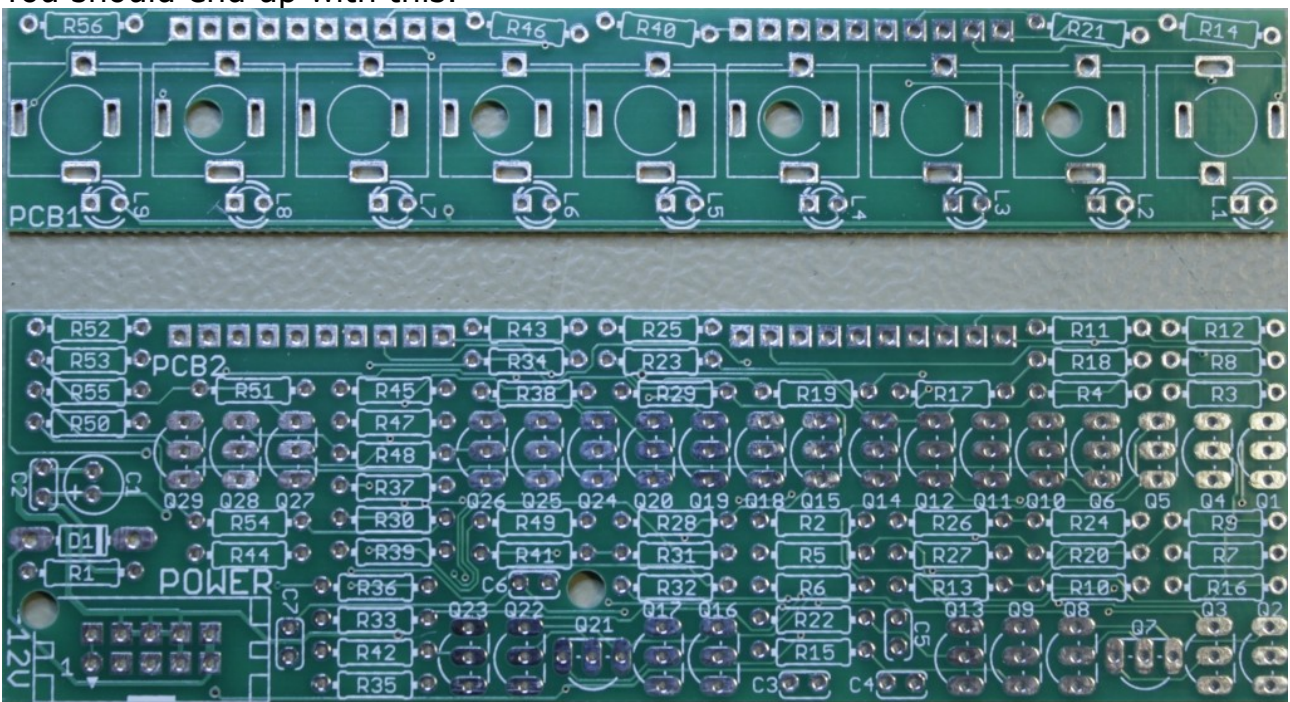

Step 1

Solder resistors. Resistors are not sensitive to mounting direction.

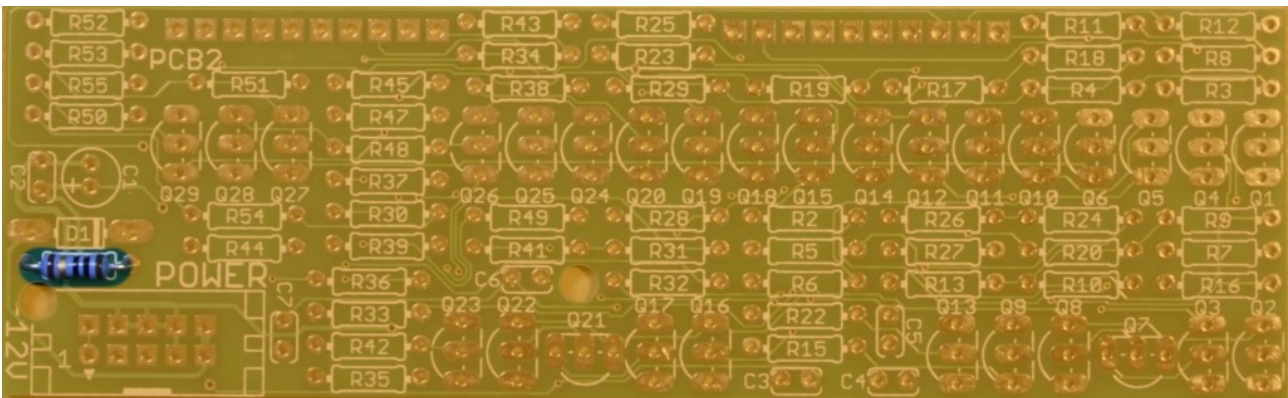

R1 10R

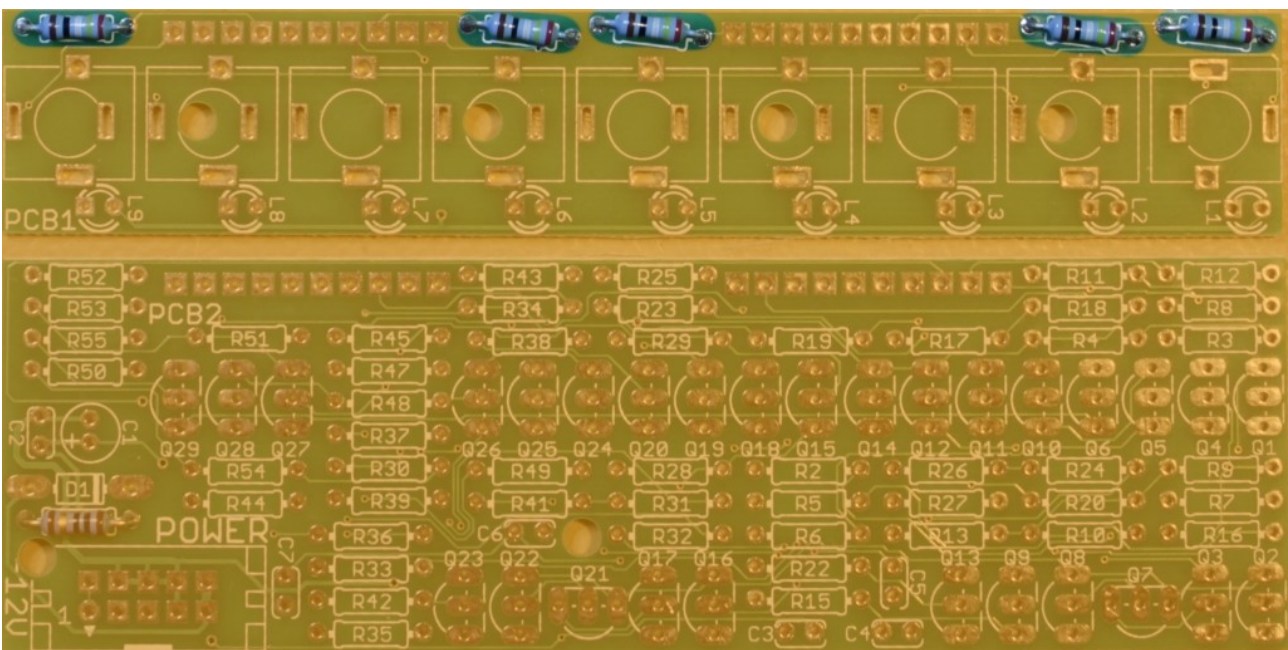

R14, R21, R40, R46, R56 249R

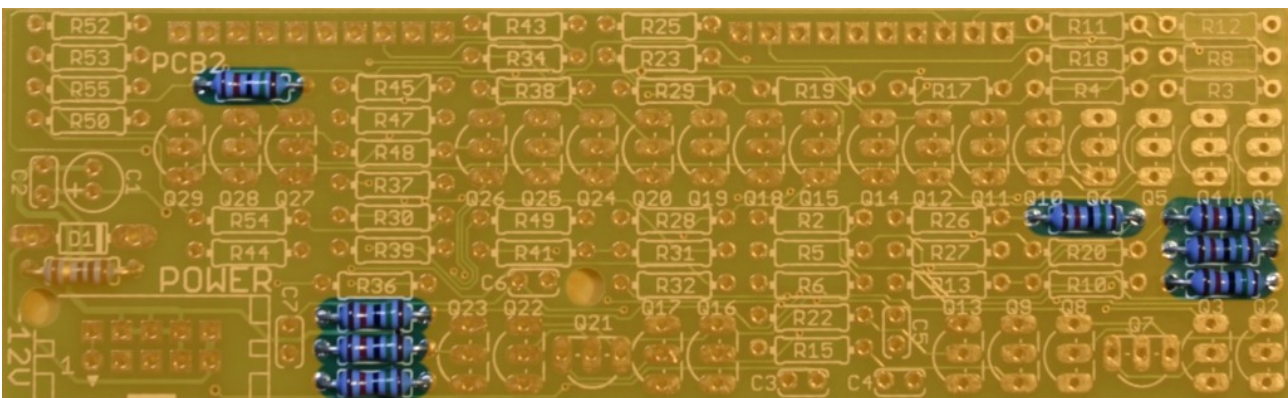

R7, R9, R16, R24, R33, R35, R42, R51 15k

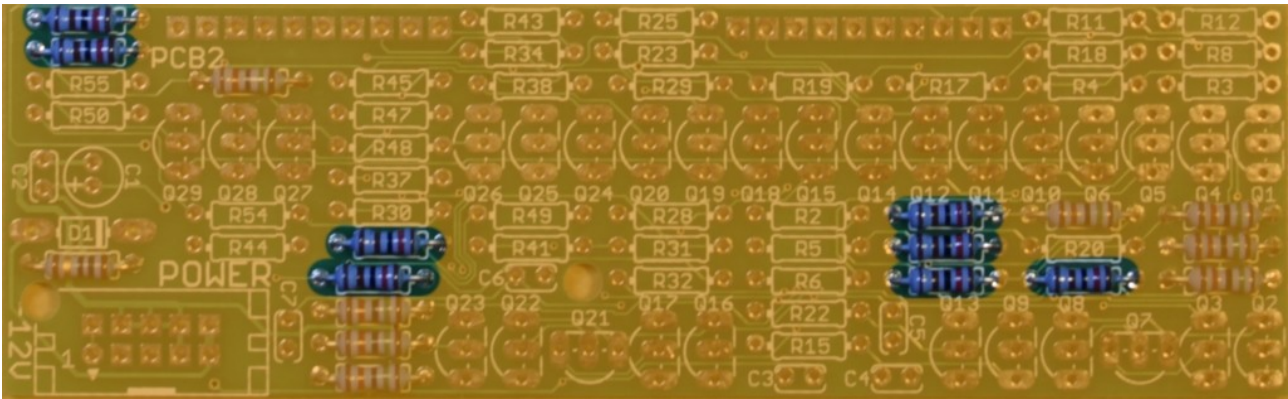

R10, R13, R26, R27, R36, R39, R52, R53 1.2k

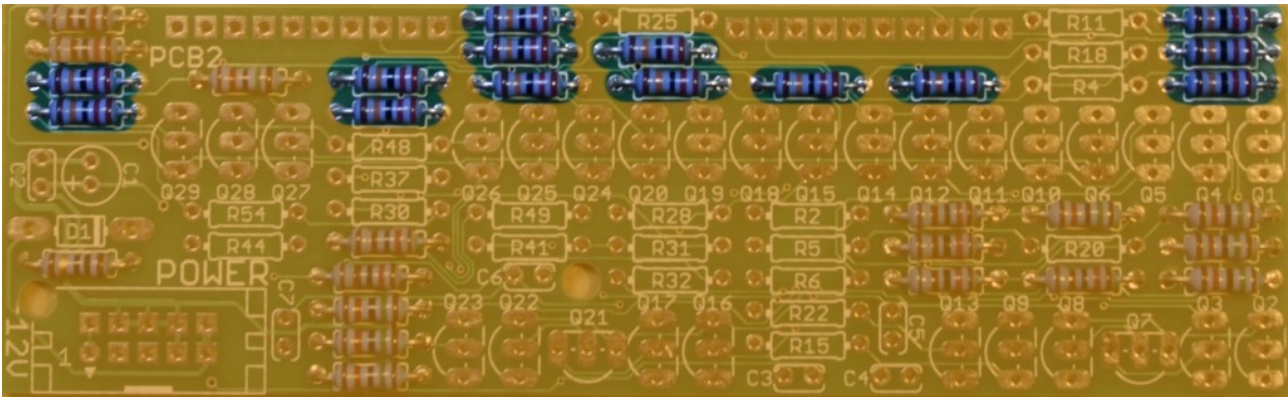

R3, R8, R12, R17, R19, R23, R29, R34, R38, R43, R45, R47, R50, R55 220k

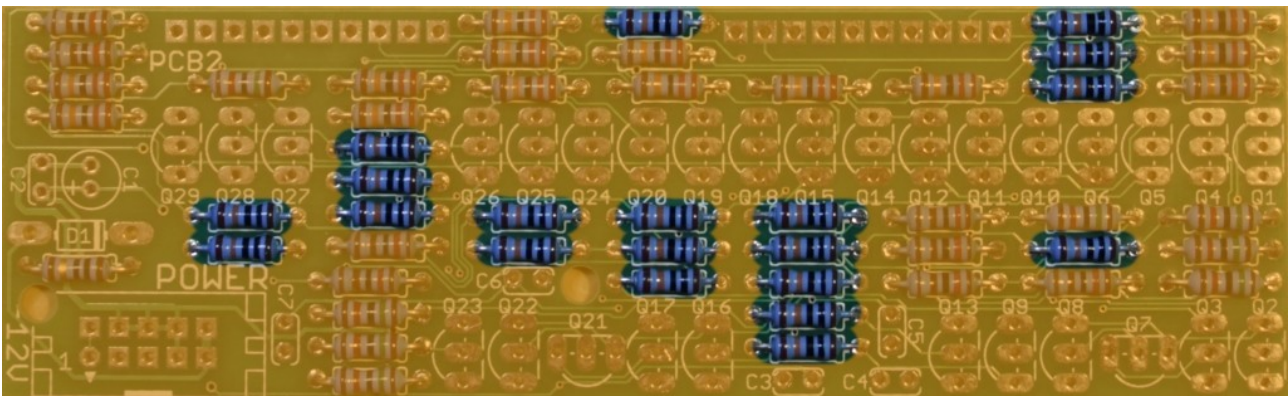

R2, R4, R5, R6, R11, R15, R18, R20, R22, R25, R28, R30, R31, R32, R37, R41, R44, R48, R49, R54 100k

Step 2

Solder reverse polarity protection diode. Diodes are sensitive to mounting direction, the stripe on the diode must be on the same side as indicated in the silk screen.

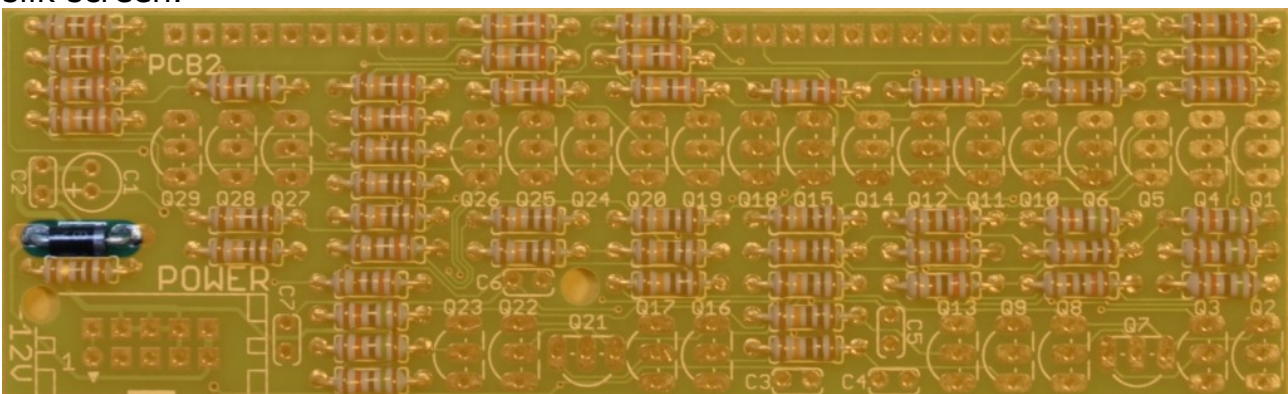

D1 1N5818

Step 3

Solder ceramic capacitors. Ceramic capacitors are not sensitive to mounting direction.

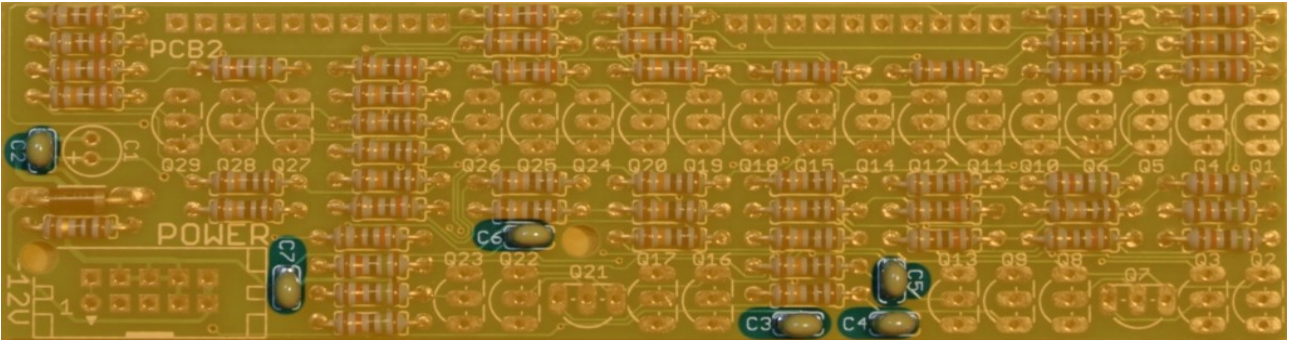

C2 C3, C4, C5, C6, C7 100nF

Step 4

Solder Electrolytic. Long leg is + (anode).

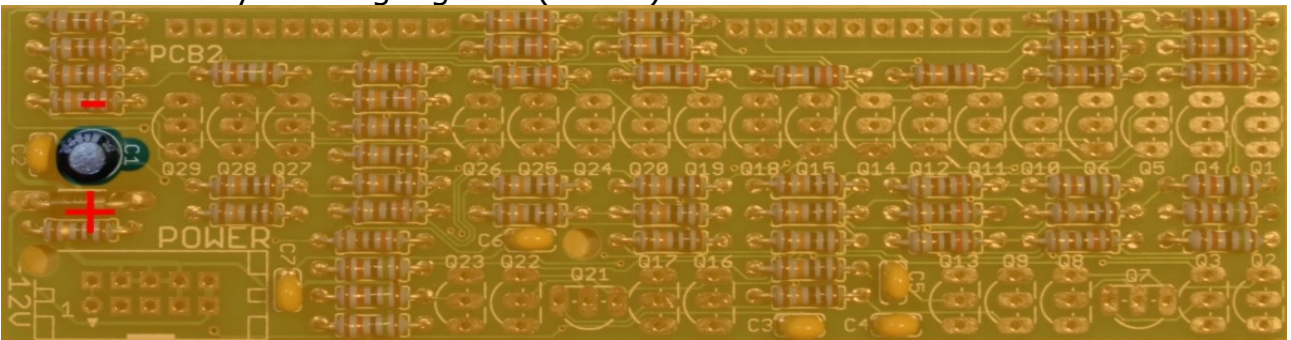

C1 10 μ F

Step 5

Solder transistors. Match the curved side with the silk screen.

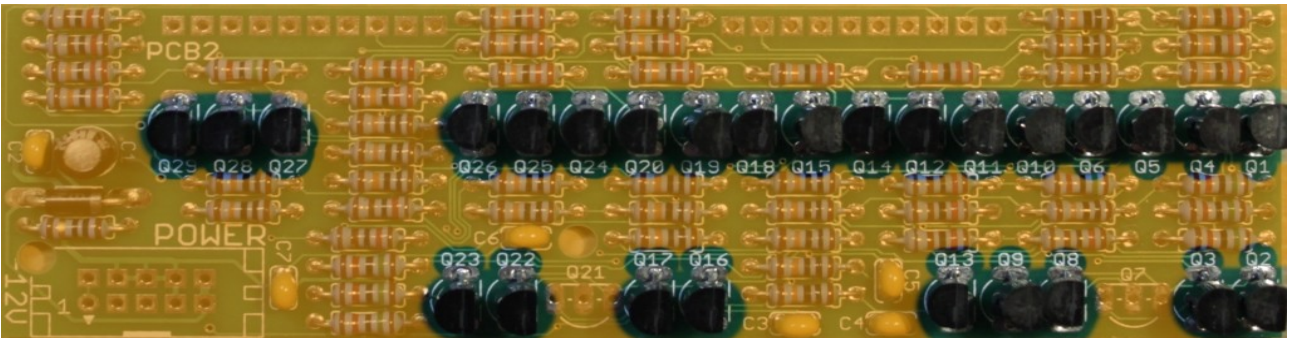

Q1, Q2, Q3, Q4, Q5, Q6, Q8, Q9, Q10, Q11, Q12, Q13, Q14, Q15, Q16, Q17, Q18, Q19, Q20, Q22, Q23, Q24, Q25, Q26, Q27, Q28, Q29 BC547B

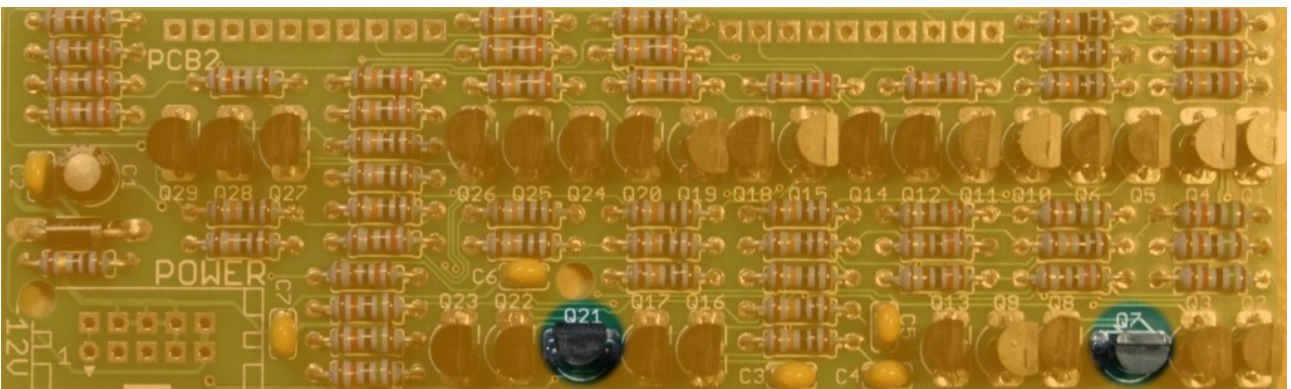

Q7, Q21 BC557B

Step 6

Solder the keyed power header. Pay extra attention to the direction. The triangle (pin 1) must be at the -12V side. In the picture below the slot opening (key) is marked with a red arrow.

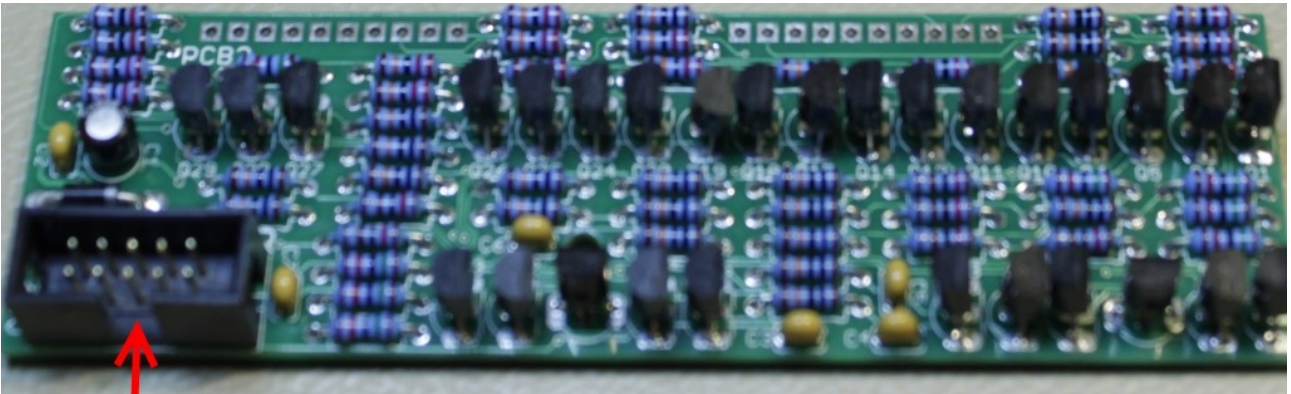

POWER

Step 7

Solder the two angled 10 pin strips in place on PCB2 like in the picture below. Only solder one pin on each pin strip and then check the angle of the pin strips. It should be a straight 90 degree angle. Adjust them if needed and solder the rest of the pins.

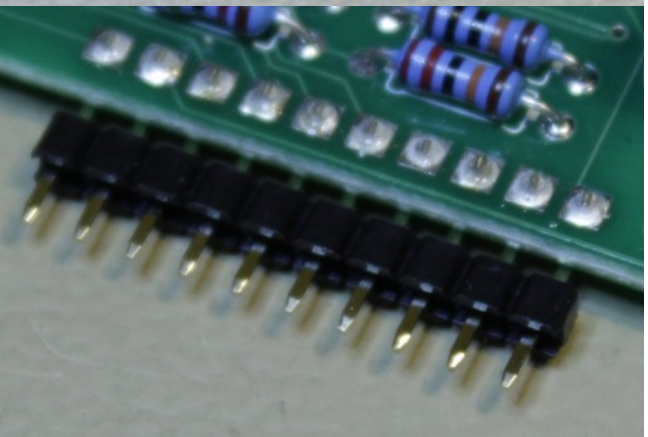
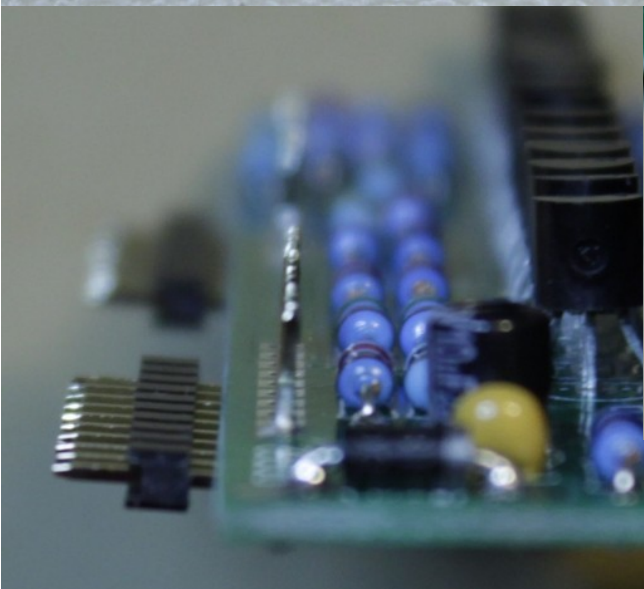
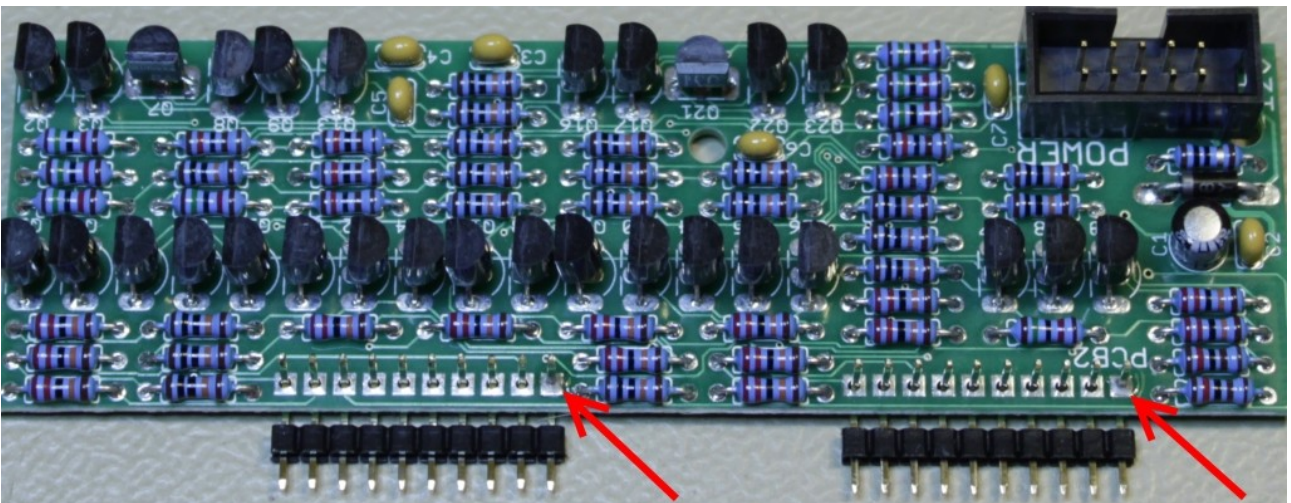

Step 8

If there is a gap between PCB2 and the plastic part of the pin strip soldered in the previous step, use PCB1 to push the plastic part in toward PCB2 until there isn't a gap any more.

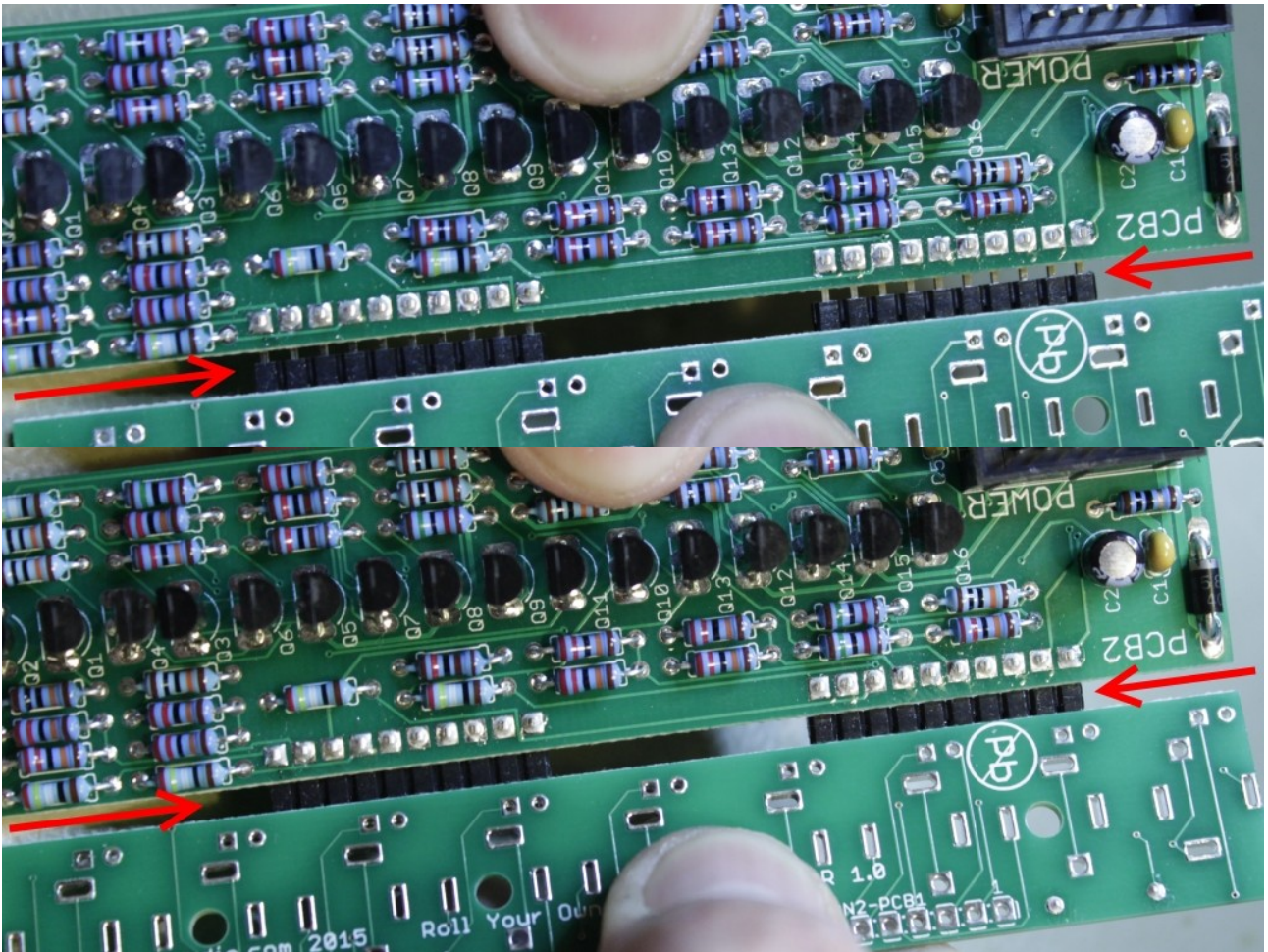

Step 9

Place the jacks in their places without soldering them and mount the panel over the jacks with the help of a washer and a nut on each jack. Don't worry if the jacks twist a tiny bit in their socket while tightening the nut, this is normal, as long as it's not soldered yet it won't be stressed. Use a socket wrench to keep the risk of scratching the panel to a minimum. Try not to make any corner of the top and bottom jack reach outside the PCB.

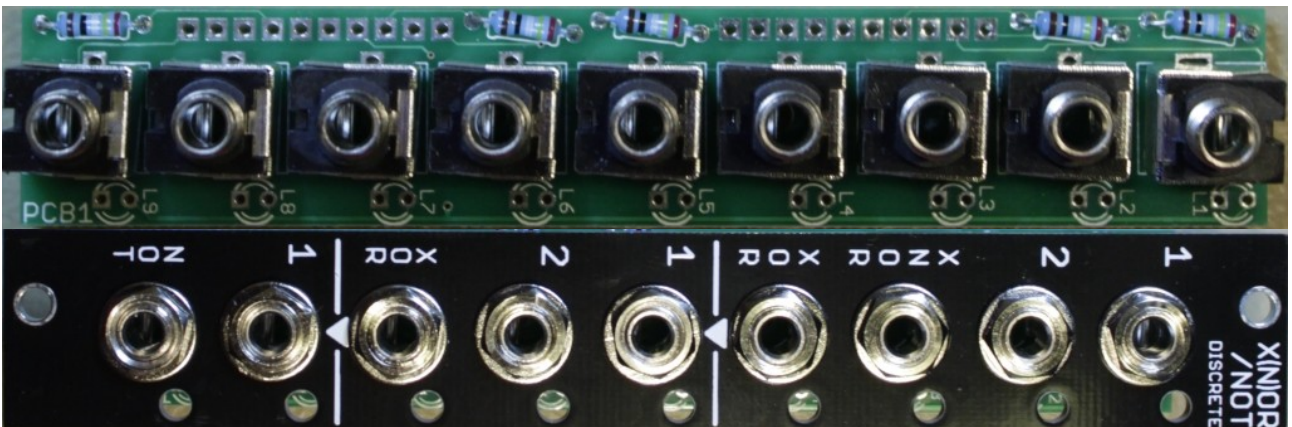

Now you can solder the jacks in place.

Step 10

Place the LEDs in their position like in the pictures below. The long pin of the LEDs are anode (+) and goes in the hole with a square pad. Green LEDs for the inputs and orange for the outputs.

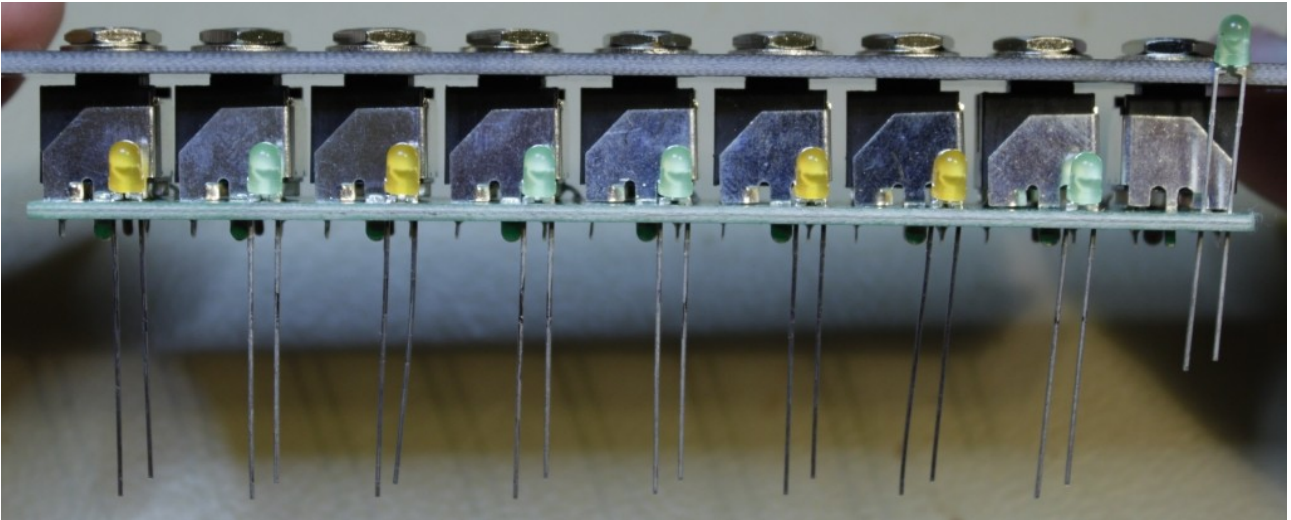

Turn the module around and guide the LEDs to their respective panel holes. Solder one pin on each LED and then check that they are in their proper place before soldering the second pin.

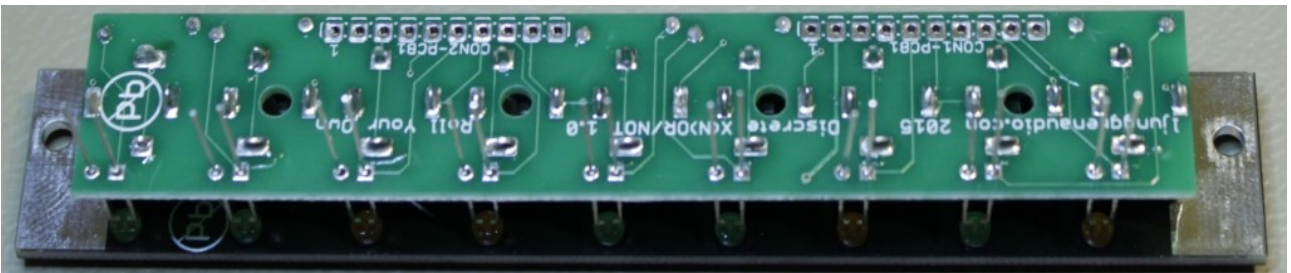

Step 11

Solder the two angled 10 pin strips in place on PCB1 like in the picture below. One pin on each pin strip first, then check the angle and adjust if needed before soldering the rest of the pins.

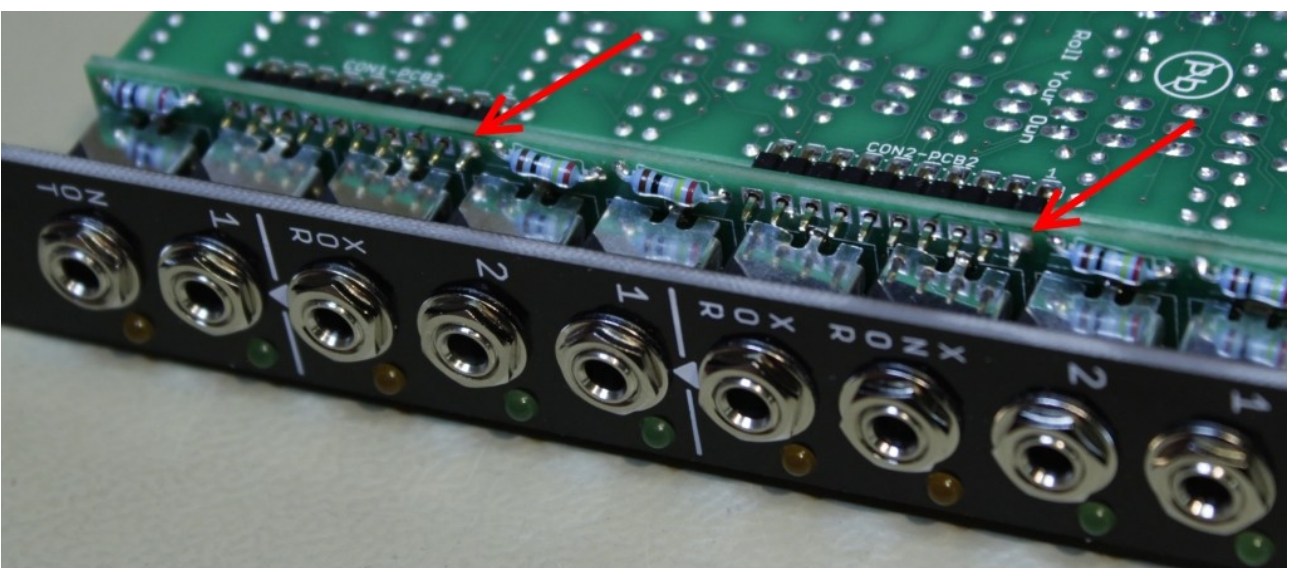

Step 12

Time to attach the power cable and the module is complete. We hope that you will have much fun with your new module!

