



## Music Thing Modular Spring Reverb Mkii version

**PLEASE DO NOT LINK TO OR REDISTRIBUTE THIS DOCUMENT WITHOUT PERMISSION FROM THONK**

For the most recent version of this document please visit –  
<https://thonk.co.uk/documents/springreverb/>

Refer also to the Music Thing documentation here - <http://bit.ly/2hwUvvq>

For all technical support please create a Github account and log an issue here -  
<https://www.thonk.co.uk/spring-github/>

Chat about the build here –  
<https://www.thonk.co.uk/spring-muff/>



All Thonk kits are sold under our standard Terms and Conditions -  
<http://www.thonk.co.uk/faq/>

## DIY INSTRUCTIONS

This document gives detailed instructions that assume you have purchased a complete Music Thing Modular Spring Reverb MkII kit from [www.thonk.co.uk](http://www.thonk.co.uk) after November 2017, it also assumes no previous knowledge of electronics.

To learn to solder try <https://www.youtube.com/watch?v=lpkkfK937mU> and the **Adafruit guide to excellent soldering** – <http://bit.ly/1I77tF4>

**Watch and understand that whole YouTube video! If you're not achieving the results shown in the video then you need to buy new tools or seek advice.**

**You will not end up with a working unit otherwise.**

## TOOLS REQUIRED

Soldering iron, snipe nose pliers, wire strippers, small flat head screwdriver and diagonal cutters AKA snips AKA side-cutters. A Digital Multimeter is always helpful for checking for bad solder joints and continuity. Thonk sell a range of inexpensive tools here - <http://bit.ly/1jxqF3n>



## SOLDER JOINTS

Your solder joints should look like those shown as 'OK' below, they should have that neat conical shape on **BOTH sides of the PCB**. If they don't look the same on both sides then stop! Work out why from the soldering guides linked and don't continue until you are getting those results.

This isn't about perfectionism, you are very likely to end up with a destroyed, damaged or defective unit if you're not hitting that standard.

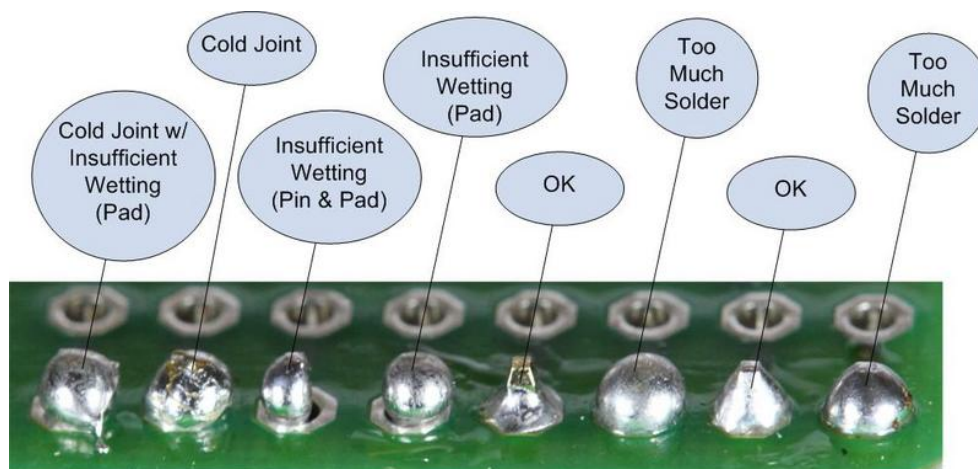

This photo is from the **Adafruit guide to excellent soldering** - <http://bit.ly/1177tF4> and is reproduced under an Attribution-Sharealike creative commons license - <http://creativecommons.org/licenses/by-sa/3.0/>

## IDENTIFYING RESISTORS

We are now shipping resistors in shared bags to save on the amount of plastic contained in our kits, to stop less of it ending up in the ocean we hope... but hopefully without making our builds harder to complete.

We always make sure that the resistors are grouped together in different amounts so it's hard to mix them up **as long as you can count...**

We highly advise the practice of **testing one resistor of each value** with a **digital multimeter** BEFORE soldering. We do this at Thonk and it reduces build errors greatly, if you don't have a digital multimeter buy one! Or failing that use this colour code calculator URL instead (we always ship with 1% resistors so band 5 is always **BROWN**).

<https://www.digikey.co.uk/en/resources/conversion-calculators/conversion-calculator-resistor-color-code-5-band>



## SPRING REVERB BUILD INSTRUCTIONS

1.

To start with we advise emptying the bags into two separate bowls or containers so it makes it easier to find parts.

This document has hi-res images.  
**ZOOM IN** for a closer look

2.

There are two PCBs included in the kit, FRONT and BACK as shown. We will be soldering components to both boards during the build so care must be taken to not absent-mindedly solder parts to the wrong board!

**BACK PCB**

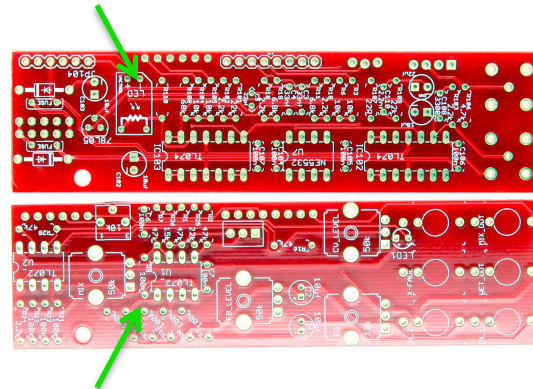

**FRONT PCB**

3.

First identify the resistor bag with the nine **100K** resistors and solder into the positions shown on the **FRONT PCB**

**R4, R5, R8, R9, R12, R13, R21, R22, R23**

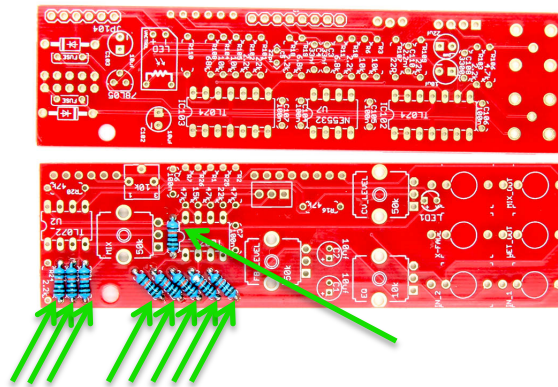

4.

In the same bag you'll also find two **6.8K** resistors, solder them into the positions **R11** and **R19** shown on the **BACK PCB**

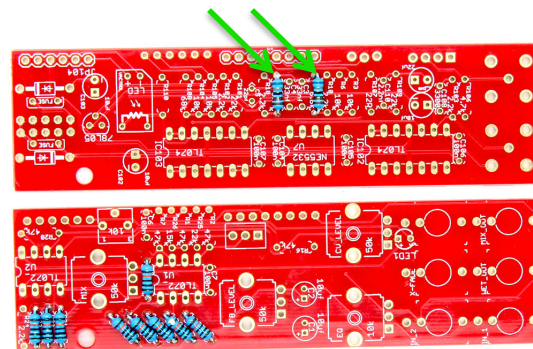



5.

Finally in that resistor bag you will have a single **15k** resistor left, solder it into position **R26** shown on the **FRONT PCB**

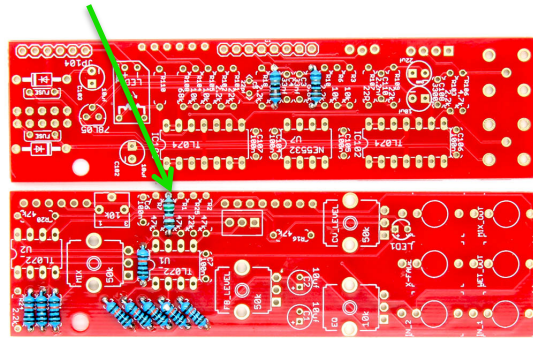

6.

Next identify the resistor bag containing the six **47K** resistors and solder into the positions shown on **BOTH PCBs**

**R1, R2, R7, R16, R20, R110**

**NOTE!** The resistance value for **R110** is not labeled as the value depends on the type of Vactrol used, for Thonk kits or when using a **VTL5C3** vactrol this should be a **47K** resistor.

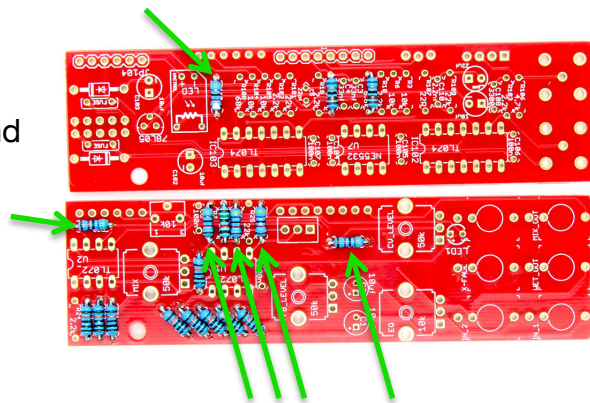

7.

In the same bag you'll also find three **22K** resistors, solder them into the positions **R25, R101** and **R109** shown on the **BOTH PCBs**

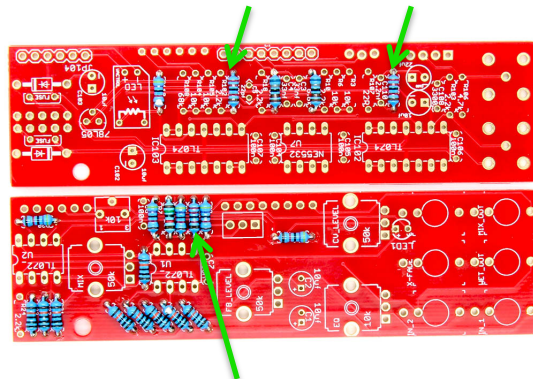



8.

Finally in that resistor bag you will have a single **68K** resistor left, solder it into position **R108** shown on the **BACK PCB**

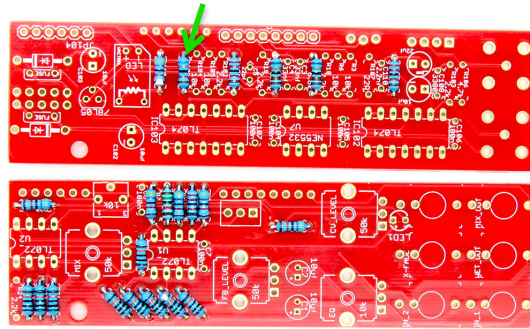

9.

Next identify the resistor bag containing the five **2.2K** resistors and solder into the positions shown on **BOTH PCBs**

**R10, R18, R24, R102, R103**

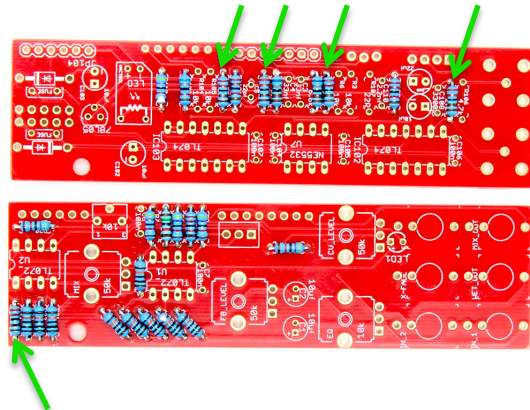

10.

In the same bag you'll also find four **10K** resistors, solder them into the positions **R3, R6, R104** and **R105** shown on the **BACK PCB**

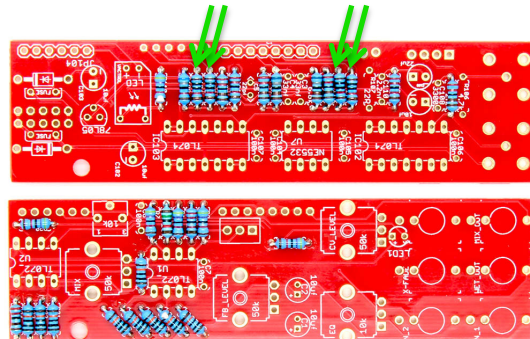

11.

Finally in that resistor bag you will have a single **4.7K** resistor left, solder it into position **R106** shown on the **BACK PCB**

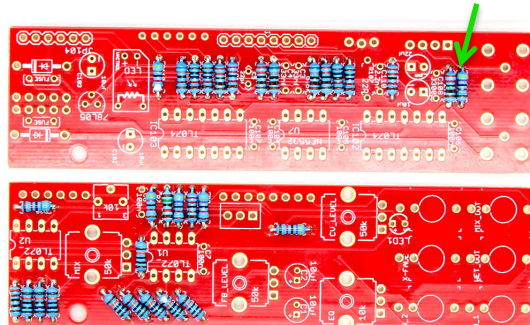



12.

Next identify the bag containing the single **22R** resistor and solder into position **R107** on the **BACK PCB**

This bag also contains a diode and a capacitor.

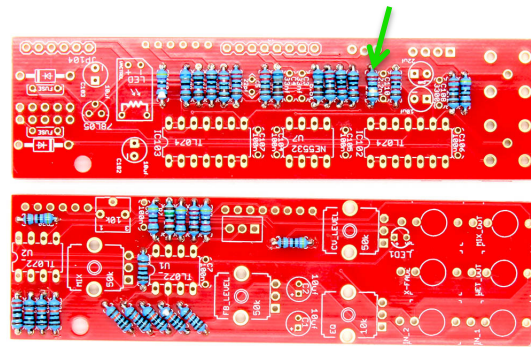

13.

Solder the two **1N4001** diodes from the same bag into the positions as shown.

**NOTE!** Orientation of this part is vital, the module will not work if they are the wrong way round.

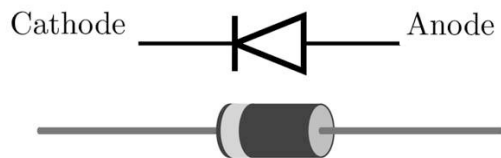

Backwards.com

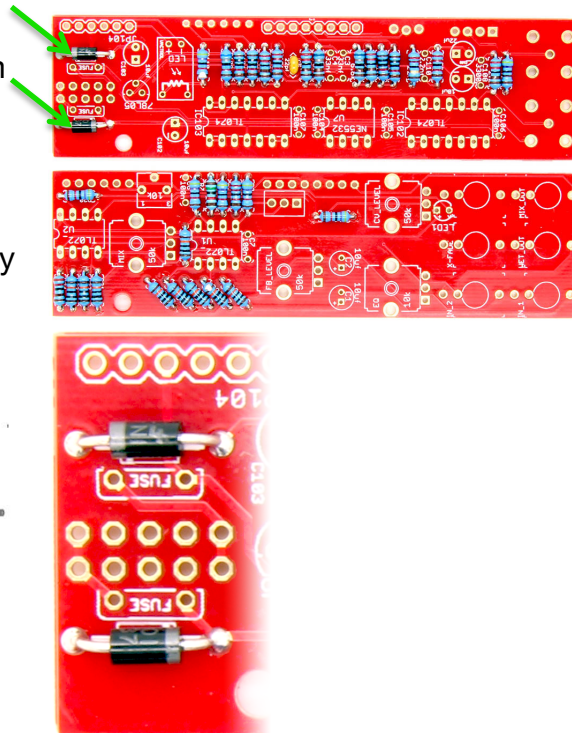

14.

Finally find the single **22pF** capacitor in the same bag and solder into position **C5** on the **BACK PCB**

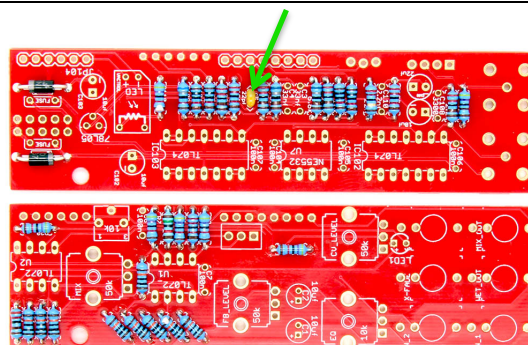



15.

Next find the bag with the single **3300pF** capacitor and solder into position **C108** on the **BACK PCB**

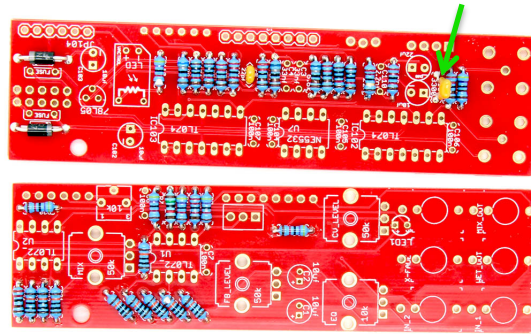

16.

Next find the bag with the single **2.2nF** capacitor and solder into position **C110** on the **BACK PCB**

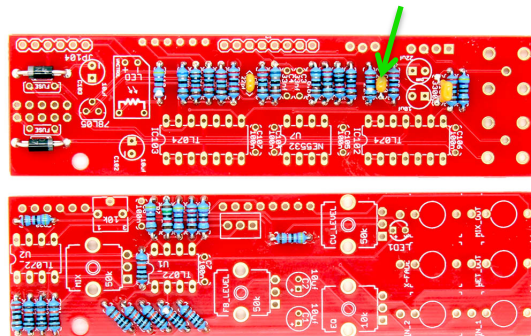

17.

Next find the larger bag of various caps and identify the 6 x **100n** capacitors and solder into the positions shown on **BOTH PCBs**  
**C6, C7, C104, C105, C106, C107**

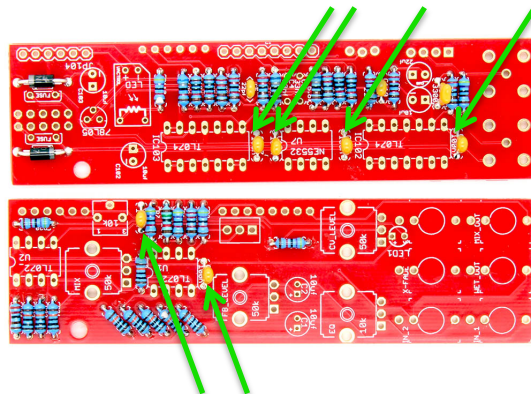



18.

Next find the larger bag of mechanical parts and pull out the five **IC Sockets**.

Make sure the **notches** in the sockets match the **notches** on the silkscreen. Solder to **BOTH PCBs**

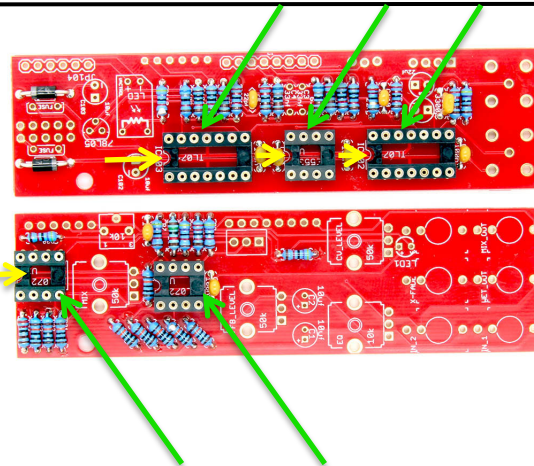

19.

Return to the cap bag and find the two **Red 33nF Polybox caps** and solder into positions **C3 & C4**

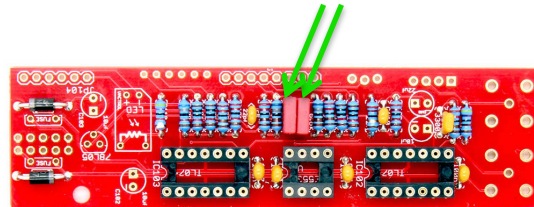

20.

Return to the cap bag and find the single **22uF electrolytic cap.** **Make sure to identify the different caps by the value written on them!** Solder into position **C109**.

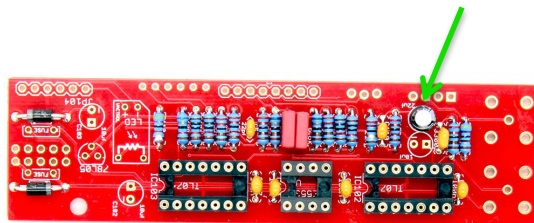

**NOTE!** The orientation is vital, the shorter lead on the component should go to the circular pad marked with a minus '-' on the PCB. Note the component has a grey stripe on the cylindrical body on the minus side, the grey stripe should be facing the adjacent yellow ceramic cap.

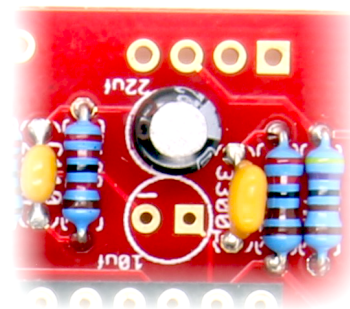





21.

Next find the square blue **10K trimmer** and solder into the position shown on the **FRONT PCB**

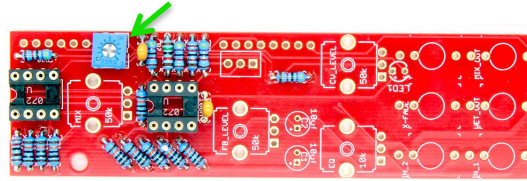

22.

Return to the cap bag and find the five **10uF electrolytic caps**. **Make sure to identify the different caps by the value written on them!** Just take **three** of them for now and solder into positions **C101**, **C102**, **C103** on the **BACK PCB**

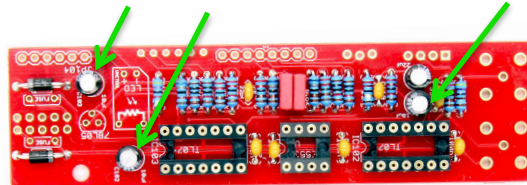

**NOTE!** The orientation is vital, the shorter lead on the component should go to the circular pad marked with a minus '-' on the PCB. Note the component has a grey stripe on the cylindrical body on the minus side.

23.

Now grab the remaining two **10uF electrolytic caps** and solder into positions **C1** and **C2** on the **FRONT PCB**

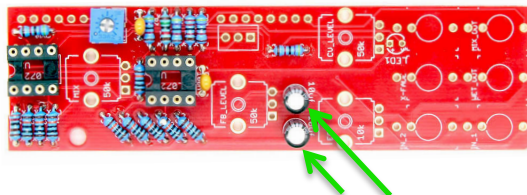

**THESE CAPS ARE MARKED DIFFERENTLY - With a PLUS sign!**

**NOTE!** The orientation is vital, the **LONGER** lead on the component should go to the square pad marked with a **plus '+'** on the PCB. The grey stripe on the cylindrical body should face the **center** of the **FRONT PCB**





24.

Locate the 10 pin Eurorack power header and solder to the **OPPOSITE SIDE** of the **BACK PCB**

**DO NOT SOLDER TO THE SAME SIDE AS THE OTHER COMPONENTS!**

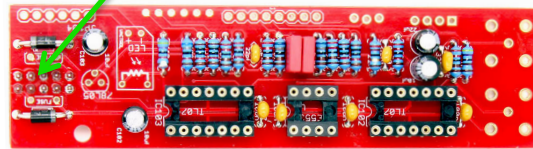
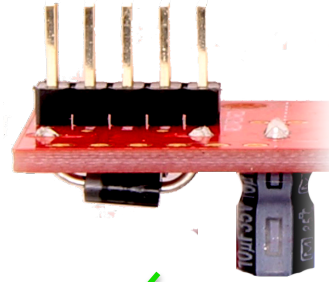

25.

Next find the small bag containing the **FUSES** and solder into the two positions shown, inbetween the two Diodes.

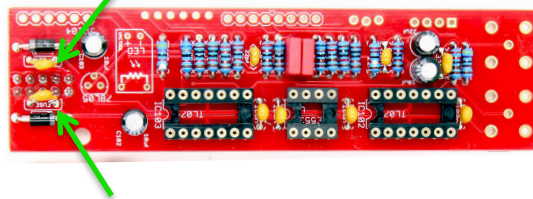

26.

Open the silver IC bag with yellow ESD sticker (read the warning) and find the **78L05** voltage regulator and solder into the position shown on the **BACK PCB**

**NOTE!** The orientation is vital, the curved body of the component must match the curved outline on the silkscreen. Take care to solder efficiently and quickly so as to not heat the component for too long.

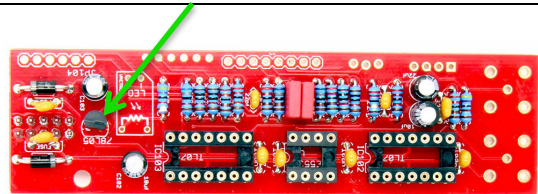



27.

Next identify the **VTL5C3** Vactrol and solder into position as shown on the **BACK PCB**

**NOTE!** The orientation is vital, make sure the LED text on the component matches the LED text on the PCB.

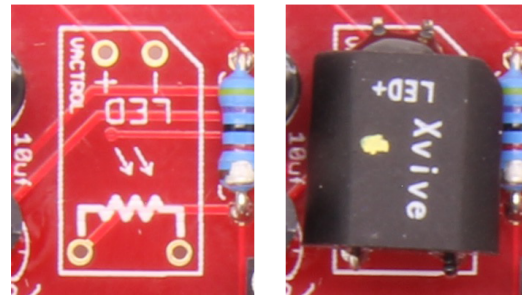
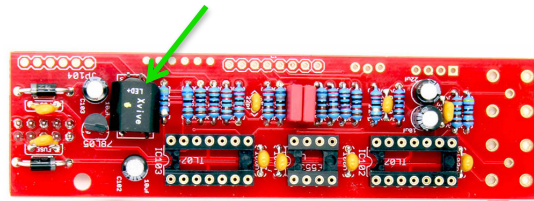

28.

Next you will solder the female headers to the rear of **BOTH PCBs**

Take care to not solder them on the **WRONG SIDE!**

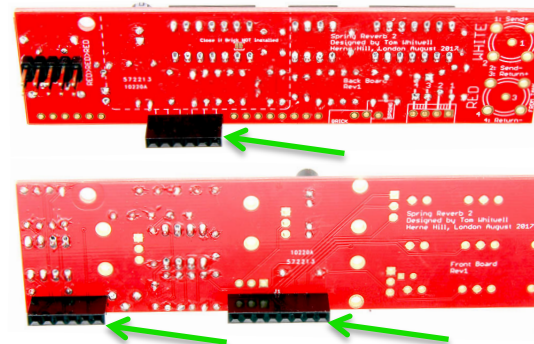
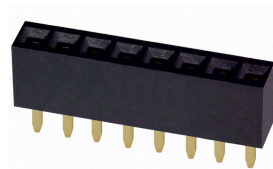

29.

Next take the male pin header and break down into one 6 pin section and one 8 pin section.

Solder into the positions shown on the **REAR PCB**, take care to solder them on the **SAME SIDE** as the resistors etc.

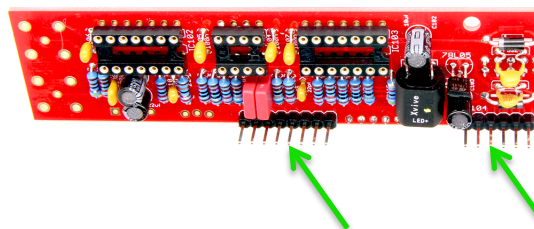



30.

Next find the two cream coloured **MTA expansion headers**, one **three pin** and one **four pin** and solder to the back on the **REAR PCB** in the positions and orientation shown.

**NOTE!** The orientation is vital, make sure the pins are exposed towards on the edge of the PCB as shown.

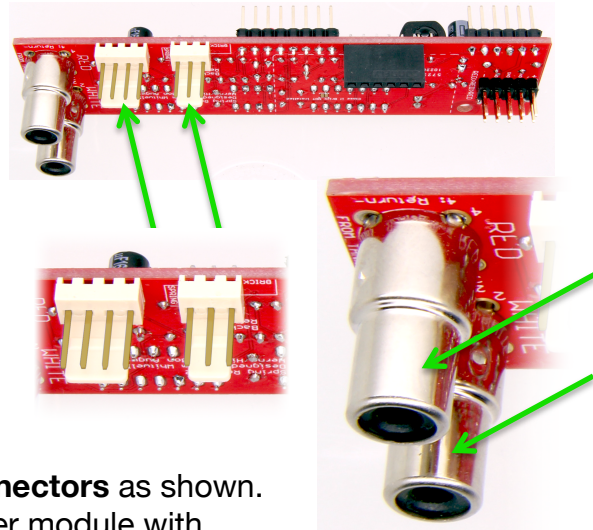

Then solder the two **RCA phono connectors** as shown. If you are planning to use the expander module with the RCA's mounted on the front panel we still recommend soldering them. Even when unused these rear phonos only add 3mm more depth to the module compared to the power cable.

31.

Position all the parts in section 42. as shown on the PCB but **DO NOT SOLDER YET!**

**Take care to get the B50K and B10K trimmer pots the right way round. Take the nuts off the jacks and pots.**

**NOTE! The longer lead of the LED MUST go to the pad marked with a + on the PCB silkscreen.**

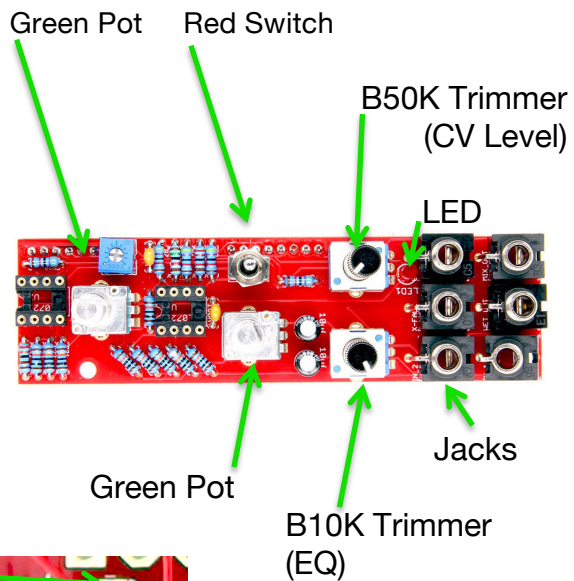
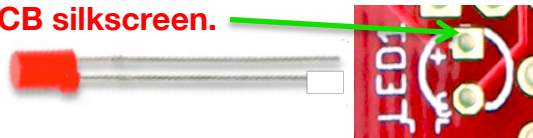

32.

Now **before soldering** put the panel on carefully and secure in two places with nuts as shown.

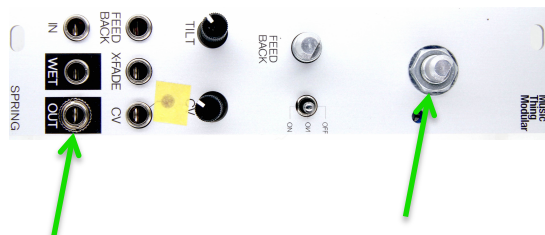



33.

In order to fit the top flat face of the LED flush with the panel we recommend using masking tape to hold its position before soldering.

You can now solder all pots, jacks the LED and the switch. Don't miss any joints! Remove the panel again when you are done.

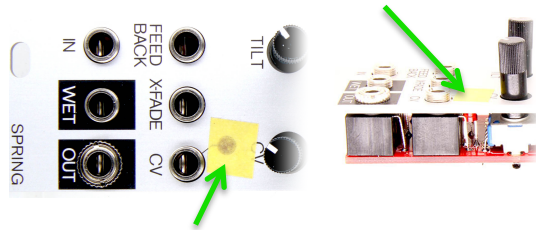

34.

Go back to the IC packet and find the two **TL074CN** and the single **NE5532P** and position as shown on the **BACK PCB**

**NOTE** – Orientation is vital! Make sure the notches in the ICs match the notches on the PCB silkscreen.

**NOTE!** You will need to bend the pins on the IC inwards slightly so they are at 90 degrees to the body of the chip. They will come slightly splayed out. This can be done safely by claspings the 4 pins in a pair of pliers (not the cutting edge near the pivot joint though!) and very gently bending inwards together. Repeat for the other side.

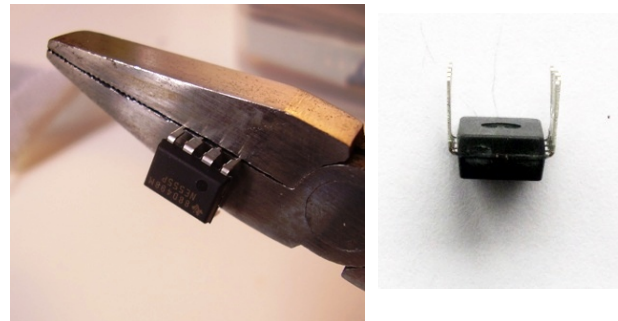
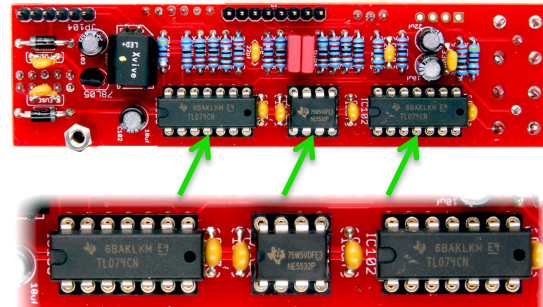

35.

Take the final two TL072CP ICs and position as shown on the **FRONT PCB**, the circle on the face should be at the notch end of the socket.

**NOTE** – Orientation is vital!

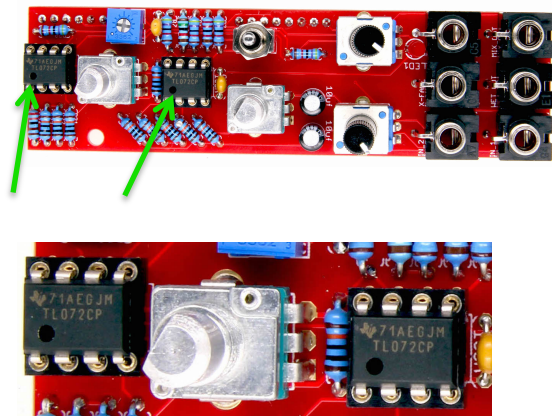



36.

Affix the hex post to the **REAR PCB** with one of the M3 screws provided.

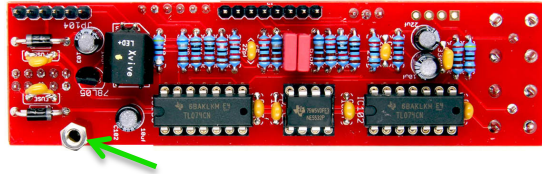

37.

Now you will sandwich the two PCBs together like so, mating the male and female headers.

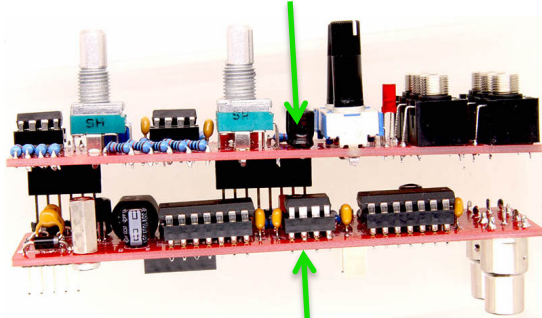

Secure the hex post with another M3 screw to hold the boards together.

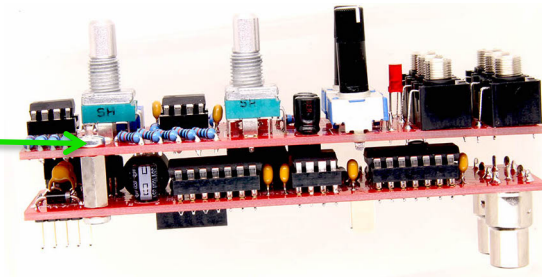

38.

If you are not installing the expander you need to position the red shunt on the 3 pin expander header. This chooses either the external real spring tank OR the digital brick attached to the back of the module.

The expander allows you to blend and crossfade between the real tank and digital brick to dial in a Custom response.

Attach the shunt even if you ARE attaching the expander as you should test the main module without the expander first.

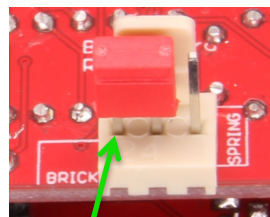

FOR DIGITAL BRICK

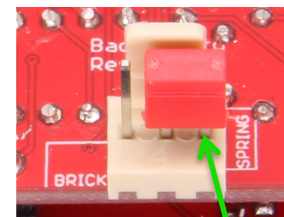

FOR REAL SPRING TANK  
(ON RCA CONNECTION)



39.

If you are fitting the digital brick you position it without soldering like so on the back of the module.

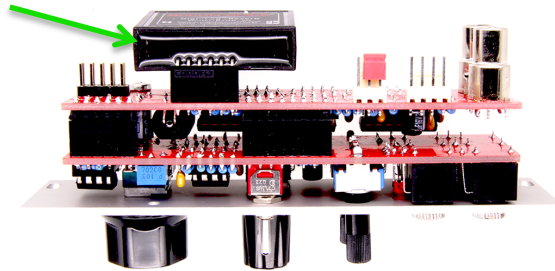

40.

If you have no intention of ever using the digital brick you can choose to solder this optional point (bridge a blob of solder between the two pads). This grounds the brick op amp, so it's not floating and potentially oscillating. We have never experienced any problems when NOT doing this, so we don't strictly recommend it as it'll be awkward to undo.

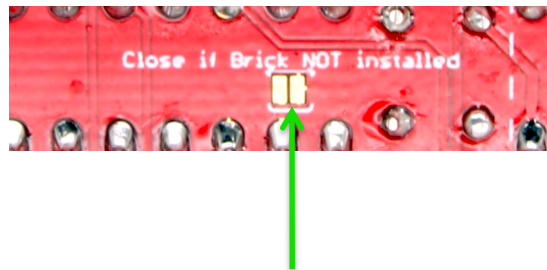

**If in doubt DON'T solder this pad.**

41.

Position the power cable like so, with the red stripe towards the center of the PCB.

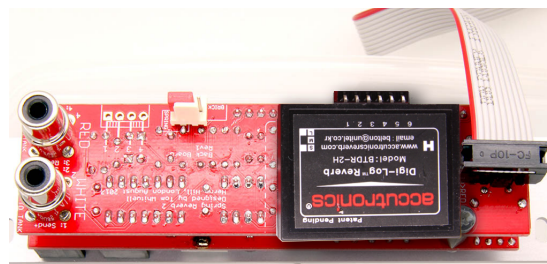

42.

If you are not using an external 'real' spring tank then you are ready to power on the module. If you are connecting a real tank or building the expander then please continue or maybe take a rest from soldering :)



43.

For real spring tank continue.  
Even if you plan to build the  
expander with external RCA's  
it's best to test with the onboard  
RCA jacks first.

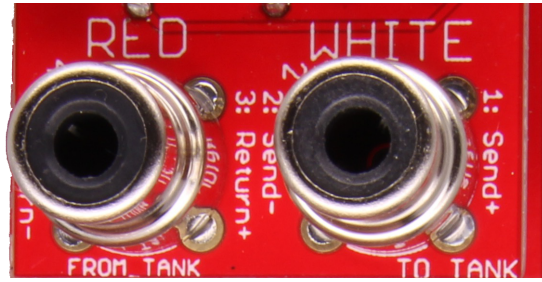

Note that there isn't any strict convention between spring tank manufacturers on red and white phono jacks. Sometimes red is input, sometimes output. So it's best to just follow the text on the PCB.

The left hand jack marked **FROM TANK** should be connected to the **OUTPUT** of the spring tank. The right hand jack marked **TO TANK** should be connected to the **INPUT** of the spring tank.

**NOTE! Spring reverb tanks are inherently sensitive to picking up noise and hum from power supplies or other electronics.** While it is tempting to build the tank **inside** your Eurorack case it can be very difficult or impossible to stop it picking up a lot of noise from the other electronics.

**When first testing your module we suggest you put the spring tank as far away as possible from your eurorack case or other electrical or electronic devices.**

**Once your tank is connected, power on! Even if you are building the expander you should test the main module first before connecting it.**

## CALIBRATION

**Calibration doesn't need specialist tools, just your EARS**

If you are using a real spring tank then before putting the big knob on the module you will want to use a small screwdriver to adjust the trimmer. This trimmer controls the wet reverb level of the REAL spring tank only. It does not affect the gain of the digital brick reverb.

We advise feeding the loudest sine wave available to the reverb module input and then patch into the wet output only. Adjust the trimmer level until you can hear the reverb start to distort and then wind it back a little bit. You may want to adjust it again later on but this is a good place to start.

For more information on this module and selecting a suitable tank read here - <https://medium.com/music-thing-modular-notes/everything-i-know-about-spring-reverb-1fb4b32abf87>





Spring Reverb Mk ii  
(November 2017 onwards)

***Eurorack DIY Kit  
Instructions***

Version 1.00

---