



Music Thing Modular Turing Machine Mkii version

PLEASE DO NOT LINK TO OR REDISTRIBUTE THIS DOCUMENT WITHOUT PERMISSION FROM THONK

For the most recent version of this document please visit –
<https://www.thonk.co.uk/documents/turing2016/>

Refer also to the Music Thing documentation here –
<https://github.com/TomWhitwell/TuringMachine/>

For all technical support please create a Github account and log an issue here –
<https://github.com/TomWhitwell/TuringMachine/issues>

Chat about the build here –
<https://www.muffwiggler.com/forum/viewtopic.php?t=159116>

All Thonk kits are sold under our standard Terms and Conditions –
<http://www.thonk.co.uk/faq/>



DIY INSTRUCTIONS

This document gives detailed instructions that assume you have purchased a complete Turing Machine kit from www.thonk.co.uk after April 2016, it also assumes no previous knowledge of electronics.

To learn to solder try <https://www.youtube.com/watch?v=lpkkfK937mU> and the **Adafruit guide to excellent soldering** – <http://bit.ly/1I77tF4>

Watch and understand that whole YouTube video! If you're not achieving the results shown in the video then you need to buy new tools or seek advice.

You will not end up with a working unit otherwise.

TOOLS REQUIRED

Soldering iron, snipe nose pliers, wire strippers, small flat head screwdriver and diagonal cutters AKA snips AKA side-cutters. A Digital Multimeter is always helpful for checking for bad solder joints and continuity. Thonk sell a range of inexpensive tools here – <http://bit.ly/1jxqF3n>



SOLDER JOINTS

Your solder joints should look like those shown as 'OK' below, they should have that neat conical shape on **BOTH sides of the PCB**. If they don't look the same on both sides then stop! Work out why from the soldering guides linked and don't continue until you are getting those results.

This isn't about perfectionism, you are very likely to end up with a destroyed, damaged or defective unit if you're not hitting that standard.

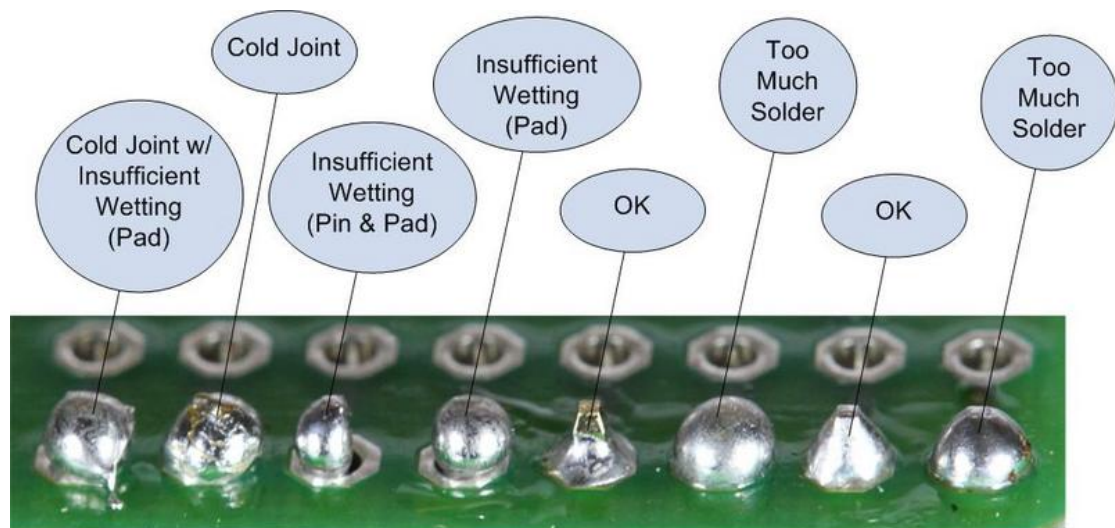

This photo is from the **Adafruit guide to excellent soldering** - <http://bit.ly/1177tF4> and is reproduced under an Attribution-Sharealike creative commons license - <http://creativecommons.org/licenses/by-sa/3.0/>



TURING MACHINE BUILD INSTRUCTIONS

1.

To start with we advise emptying the bags into two separate bowls or containers so it makes it easier to find parts.

This document has hi-res images.
ZOOM IN for a closer look

2.

Start with this PCB which we will call the **IC PCB**

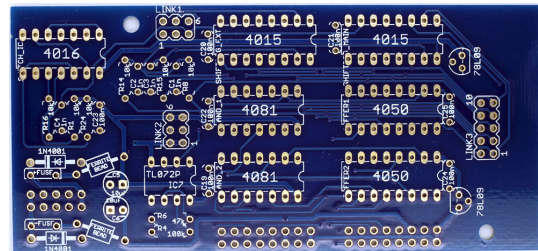

3.

First find the 10K resistors.

As you can see there are **six** resistors listed for the IC PCB:
R1, R8, R14, R15, R16 & R24



4.

Solder the six **10K** resistors into positions **R1, R8, R14, R15, R16 & R24** as shown. You should have four 10K resistors left over for the other PCB.

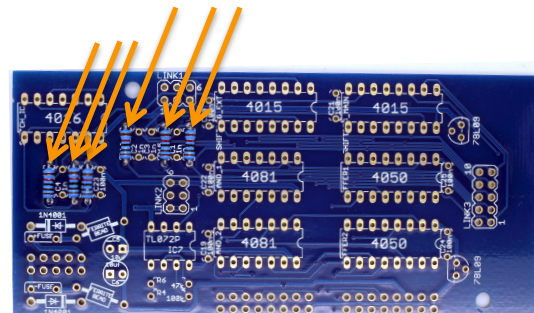

Note! Make sure your solder joints look like the joints shown on page 2, with solder coming through on **BOTH** sides of the PCB.

If you're not achieving this quality of solder joint then consider changing your iron settings or get a new soldering iron tip, or a better solder brand.



5.

Solder the single **47K** resistor into position **R6** as shown

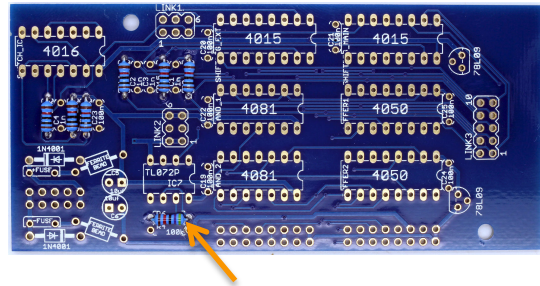

6.

Solder the single **100K** resistor into position **R4** as shown

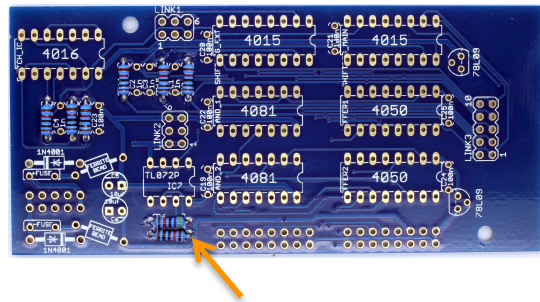

7.

Solder the two **1N4001** diodes into the positions as shown.

NOTE! Orientation of this part is vital, the module will not work if they are the wrong way round.

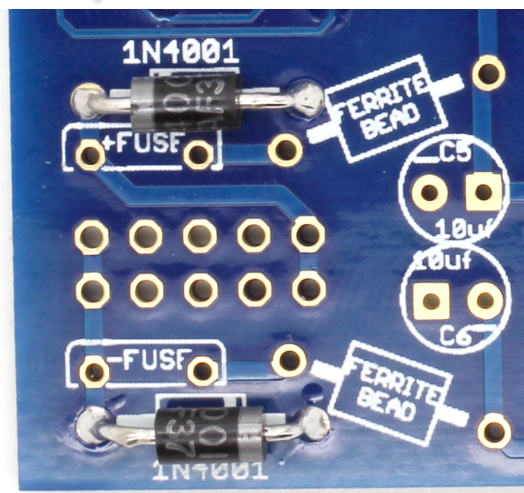
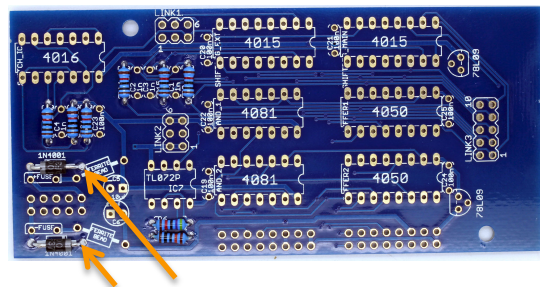
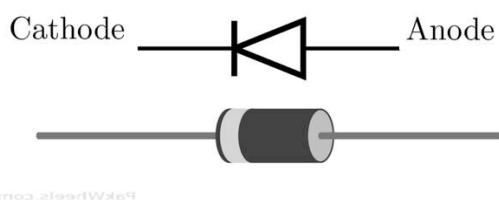



8.

Solder the two **Ferrite Beads** into place as shown.

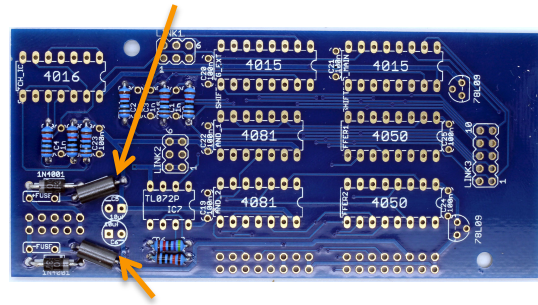

9.

Next solder the **eight IC sockets** into place. Make sure the notches in the sockets match the notches on the silkscreen.

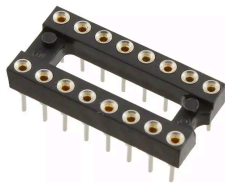

3 x 14 pin 4 x 16 pin

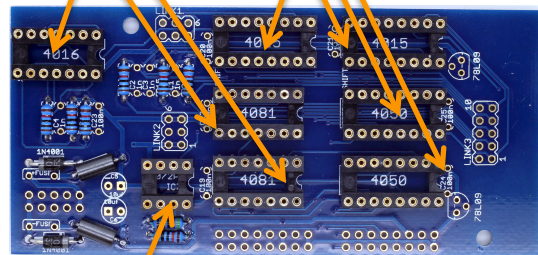

1 x 8 pin

10.

Next find the Capacitor bag and identify the six **1n** capacitors (they are on a card strip, orange and labeled '102').

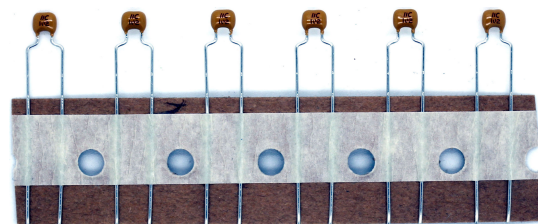



11.

Break off **four** of the **1n** caps and save two for later.

Solder those four **1n** caps into positions **C1, C2, C3 & C4**.

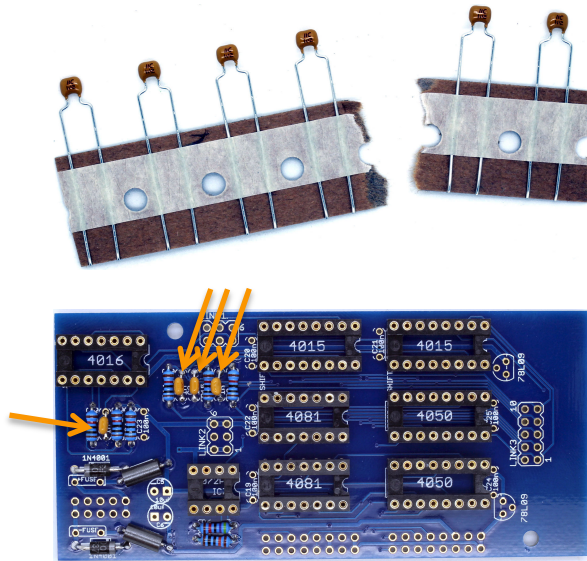

12.

Next identify the thirteen **100n** capacitors (they are on a card strip, orange and labeled '104').

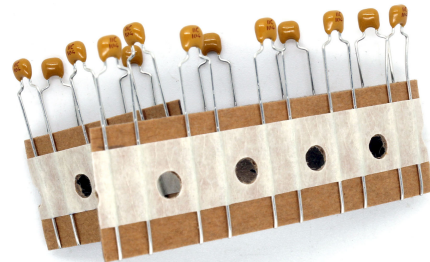

13.

Break off **seven** of the **100n** caps and save six for later.

Solder those seven **100n** caps into positions **C19, C20, C21, C22, C23, C24 & C25**.

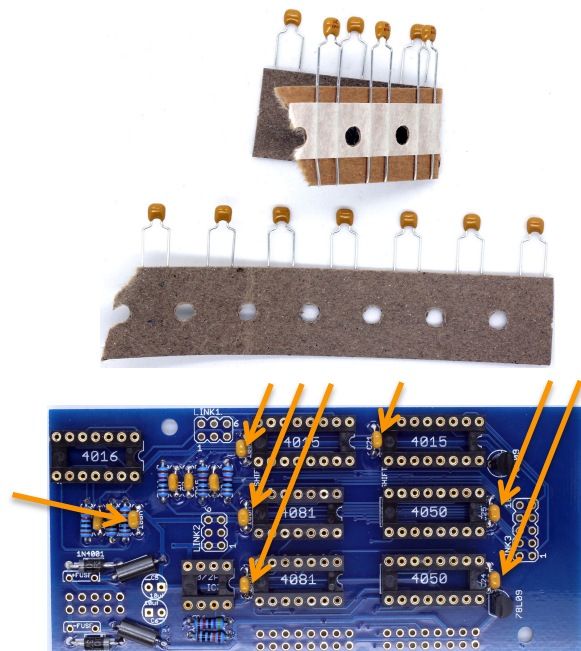



14.

Next identify the two **78L09** voltage regulators. Make sure you check the codes correctly! Do not mistake them for the single **TL431** or single **2N3904** included which look very similar. With a magnifying glass you will see **78L09** printed on the flat face.

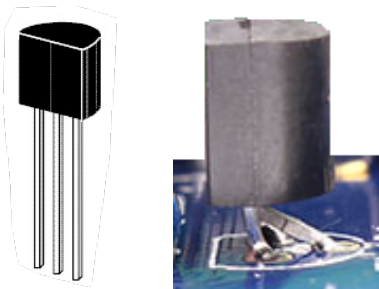

Solder into the positions shown.

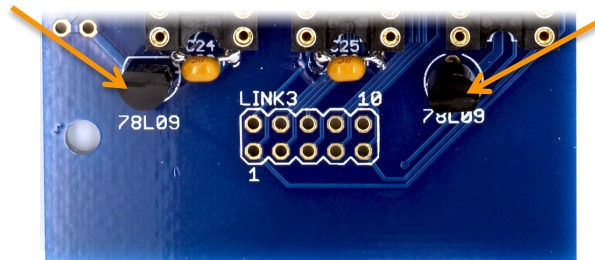
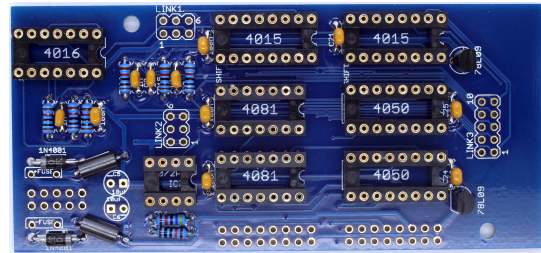

NOTE! Ensure the flat faces on the components match the flat faces on the PCB silkscreen. You need to bend the middle lead of the component backwards to achieve this to go through the centre hole. Orientation is vital.

15.

Next solder the two Electrolytic 10uF capacitors into positions **C5** and **C6**.

NOTE! The orientation is vital, the shorter lead on the component should go to the circular pad marked with a minus '-' on the PCB. Note the component has a grey stripe on the cylindrical body on the minus side.

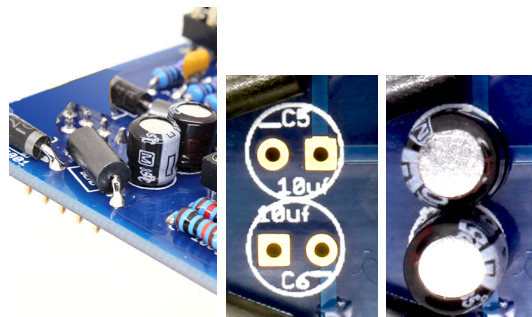
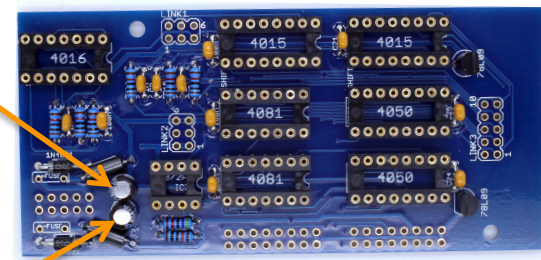



16.

Solder the three female dual row sockets into place as shown. There are two six pin sockets and one ten pin sockets. Make sure they are soldered flat against the PCB.

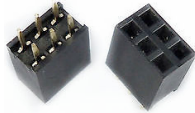

6 pin

10 pin

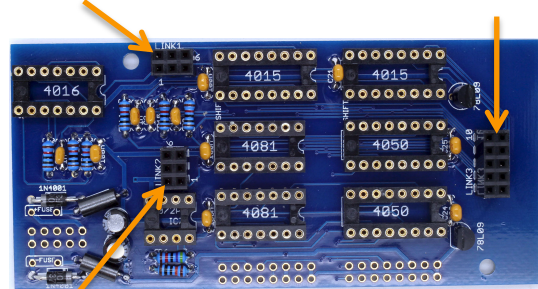

6 pin

17.

Now flip the board over and solder the two 16 pin male headers and one ten pin header.

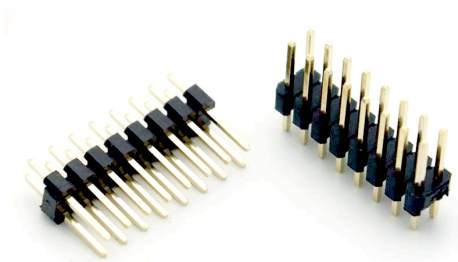

10 pin

16 pin

16 pin

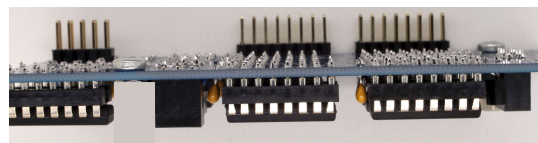
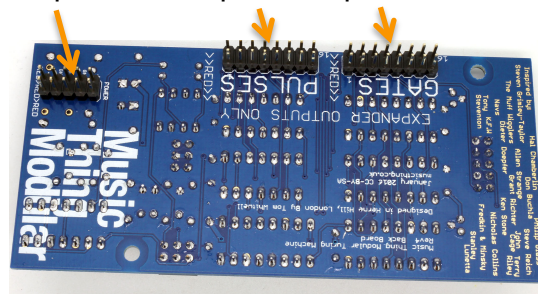

18.

Identify the two fuses and solder into place as shown. The orientation doesn't matter, but the larger fuse **MUST** go into the '+ Fuse' position.

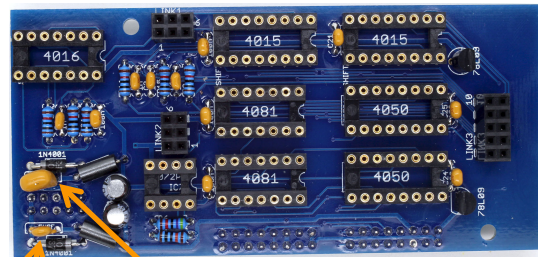
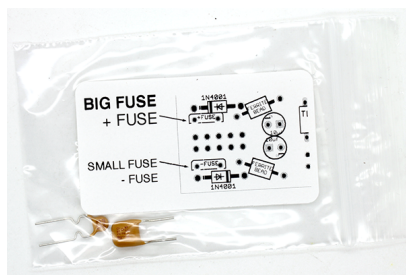

Small Fuse

Large Fuse

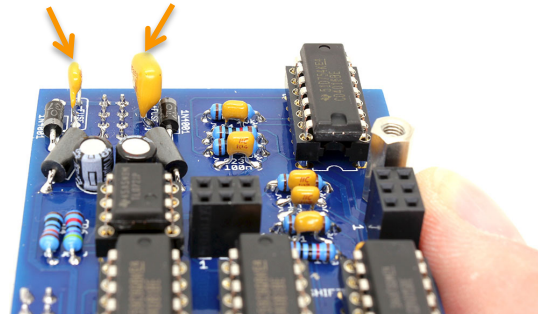



19.

Next you will place the eight IC's required on this PCB as shown.

NOTE – Orientation is vital!

NOTE! You will need to bend the pins on the IC inwards slightly so they are at 90 degrees to the body of the chip. They will come slightly splayed out. This can be done safely by claspng the 4 pins in a pair of pliers (not the cutting edge near the pivot joint though!) and very gently bending inwards together. Repeat for the other side.

NOTE! BOARD IS FLIPPED 180 DEG IN THIS IMAGE

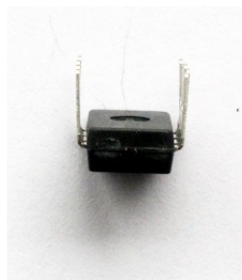
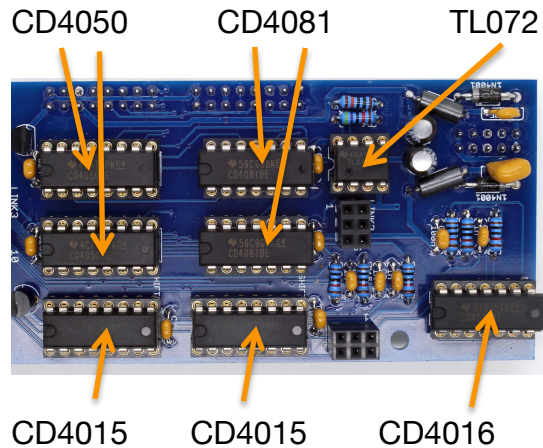

20.

Take the two hex posts and screw into the top of the board like shown with two of the screws provided.

You are now finished with the back board and are just over half-way through the build.

NOTE! Is it late? Go to bed and do the rest tomorrow, you have a far better chance of building a functioning module that way. Best soldering advice you'll ever get!

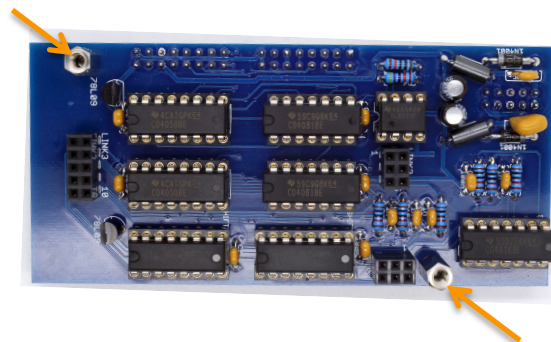



21.

Let's move onto the other PCB, which we call the 'Jack PCB'

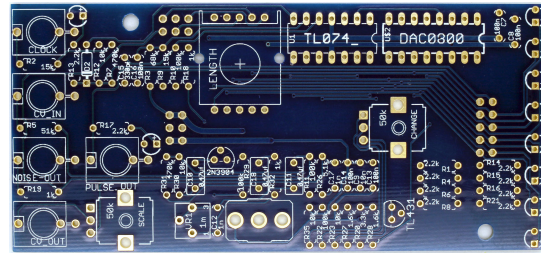

22.

Identify the single **1N4148** diode and solder into the position shown. Note the black line on the body of the Diode should match the white line on the silkscreen.

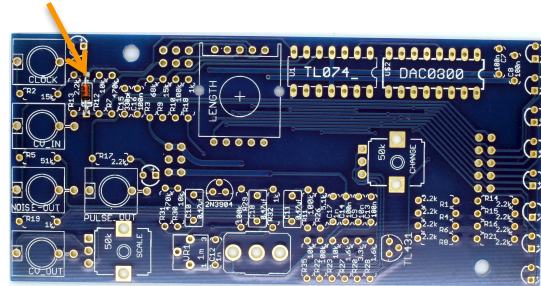

NOTE! Orientation of this component is vital.



23.

Solder the three **1K** resistors into positions **R18**, **R19** and **R32** as shown.

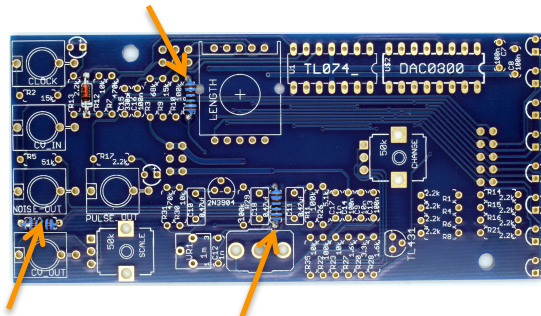

24.

Solder the two **1.6K** resistors into positions **R27** and **R28** as shown.

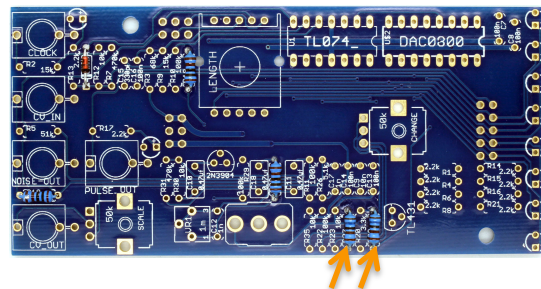



25.

Solder the ten **2.2K** resistors into positions **R1, R4, R6, R8, R13, R14, R15, R16, R17 & R21** as shown.

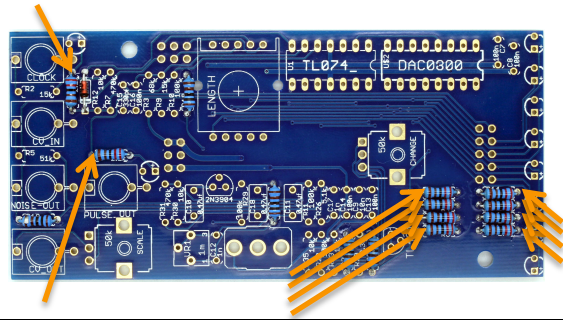

26.

Solder the single **3.3K** resistor into positions **R20** as shown.

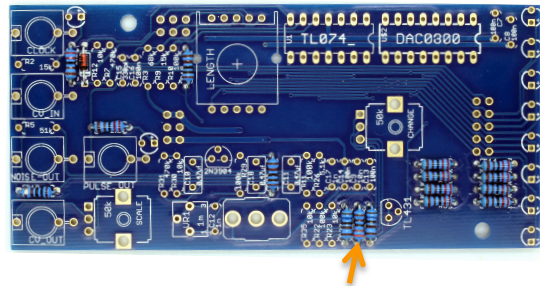

27.

Solder the single **5.1K** resistor into positions **R26** as shown.

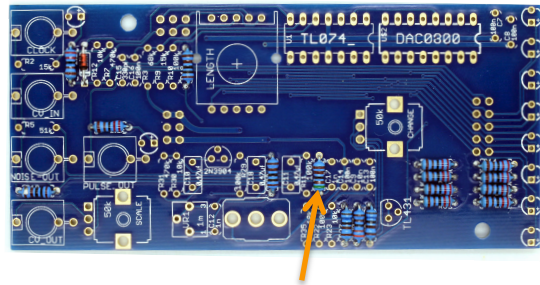

28.

Solder the two **15K** resistors into positions **R2** and **R9** as shown.

Solder the four remaining **10K** resistors into positions **R12, R23, R30** and **R35** as shown.

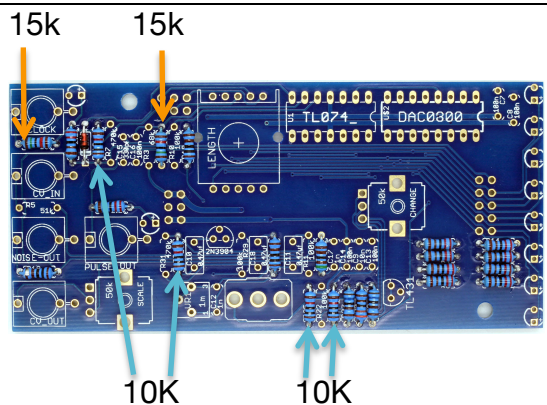

29.

Solder the single **68K** resistor into positions **R3** as shown.

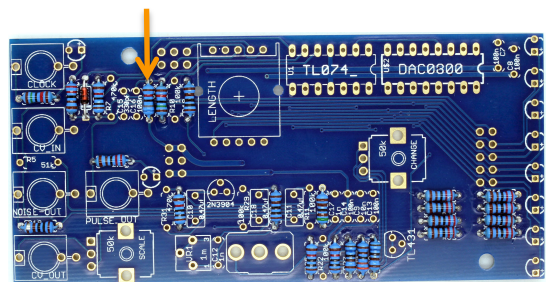



30.

Solder the single **51K** resistor into positions **R5** as shown.

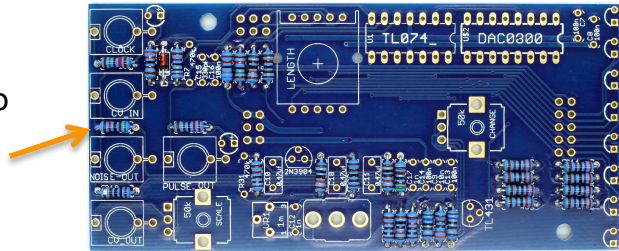

31.

Solder the four remaining **100K** resistors into positions **R10**, **R11**, **R22** and **R29** as shown.

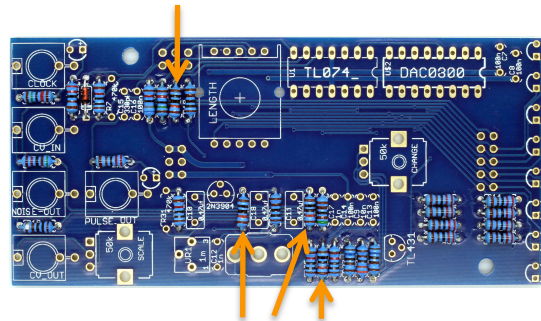

32.

Solder the two **470K** resistors into positions **R7** and **R31** as shown.

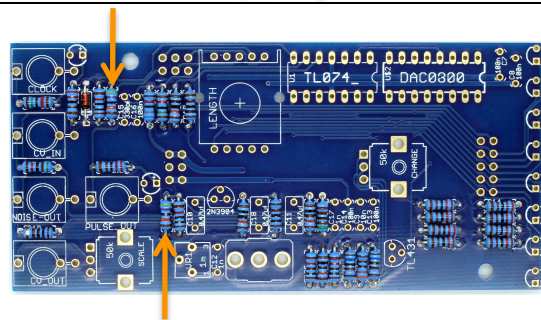

33.

Solder the two remaining **IC Sockets** into the positions shown. Make sure the notches in the sockets match the notches on the silkscreen.

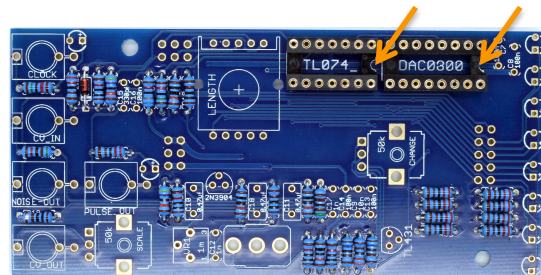

34.

Find the two remaining 1n capacitors (marked '102') and solder into positions **C12** and **C17** as shown.

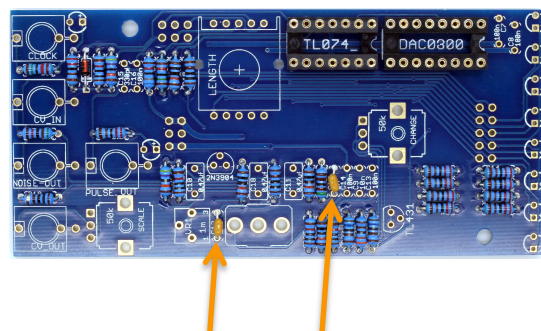
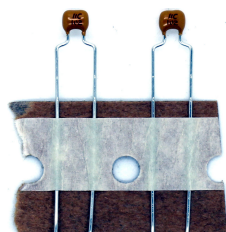



35.

Next solder the single **10n** capacitor (marked '103') into position **C9** as shown.

Next solder the remaining five **100n** capacitors (marked '104') into position **C7, C8, C13, C14 & C16** as shown.

You may have one **100n** cap spare!

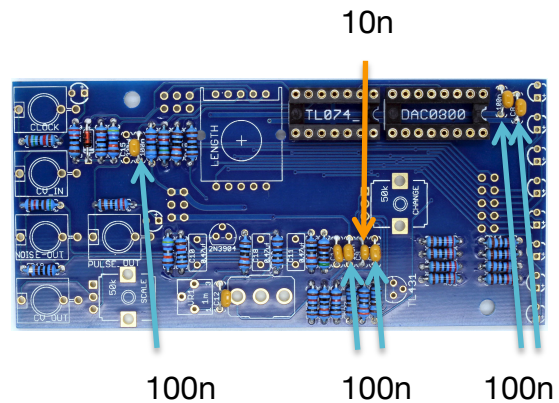

36.

Solder the single blue trimmer into position as shown. Make sure it is flush to the surface on the PCB.

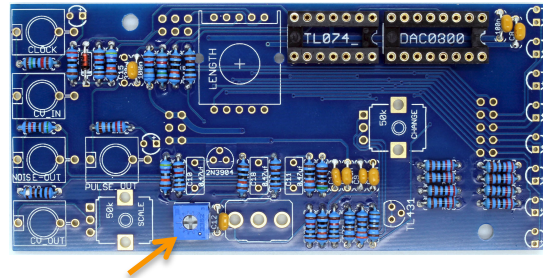

37.

Next identify the single **2N3904** transistor. Make sure you check the codes correctly! Do not mistake it for the **TL431**



Solder into the position shown.

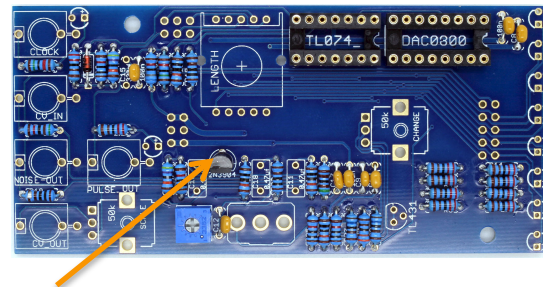

NOTE! Ensure the flat face on the component matches the flat face on the PCB silkscreen. You need to bend the middle lead of the component backwards to achieve this to go through the centre hole. Orientation is vital.



38.

Next identify the single **TL431** transistor and solder into the position shown.

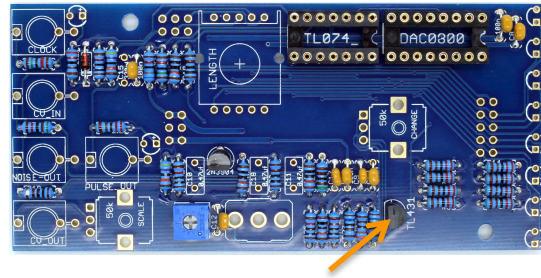
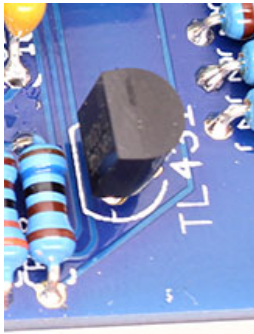

NOTE! Ensure the flat face on the component matches the flat face on the PCB silkscreen. You need to bend the middle lead of the component backwards to achieve this to go through the centre hole. Orientation is vital.

39.

Solder the three **0.47uF** film box caps into positions **C10**, **C11** and **C18** as shown.

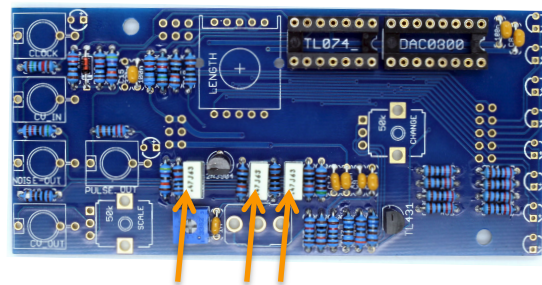

40.

Solder the single **330pF** cap into position **C15** as shown.

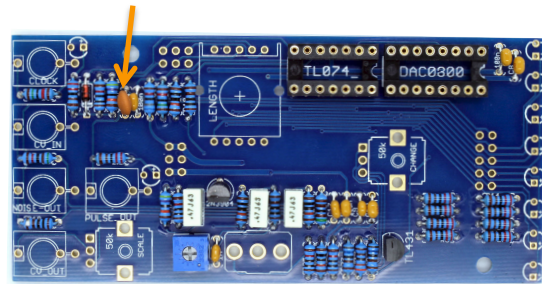

41.

FLIP THE PCB OVER and solder the three male double row pin headers into position as shown.

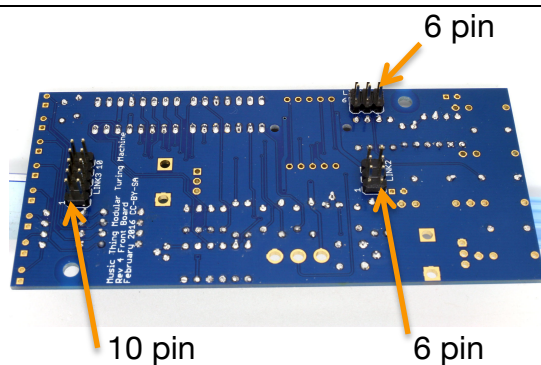
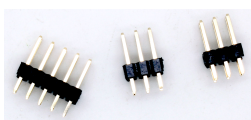



42.

Identify the following panel parts:

ROTARY SWITCH x1
(LENGTH)



TOGGLE SWITCH x1
(WRITE)



Remove all washers and nuts from the red switch. Only use one nut and discard the rest.

B50K Pot x1
(CHANGE)



B50K Pot x1
(SCALE)



THONKICONN
JACK SOCKETS x5



RED LED's x10



If your pots have the small anti-rotation tag on then break them off first.

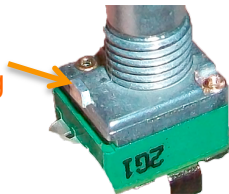

43.

DO NOT SOLDER YET

Position all the parts in section 42. as shown on the PCB but **DO NOT SOLDER YET!**

NOTE! The longer lead of the LED **MUST** go to the pad marked with a + on the PCB silkscreen.

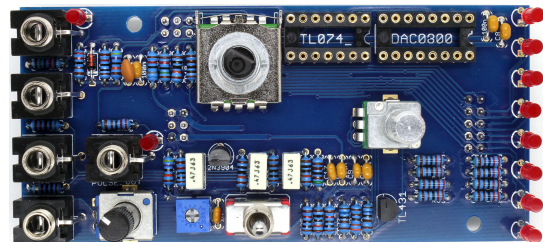



44.

If you want to fit the flat head LEDs so they fit flush to the panel then apply masking tape over the 10 LED holes in the front panel.

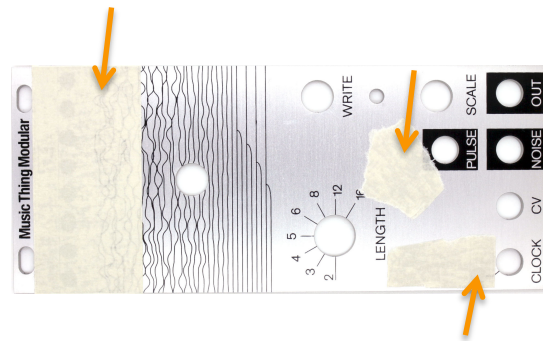

45.

Now position the panel onto the PCB, making sure that the jacks, pots and switches are all aligned correctly and the panel is sitting completely parallel to the PCB and flush to the tops of the components.

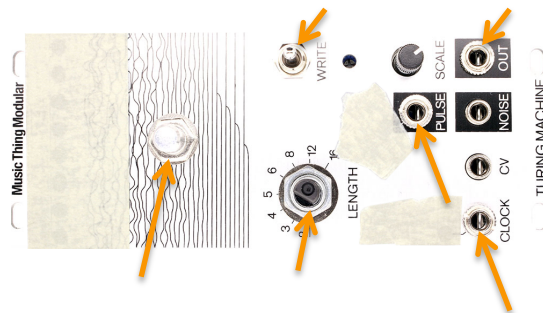

Secure into place by hand tightening the Pot and switch nuts and a couple of jack nuts.

46.

Before you solder you're going to push all ten LEDs into the holes into the panel, so the flat heads are sticking to the masking tape and held nicely flush with the surface of the panel.

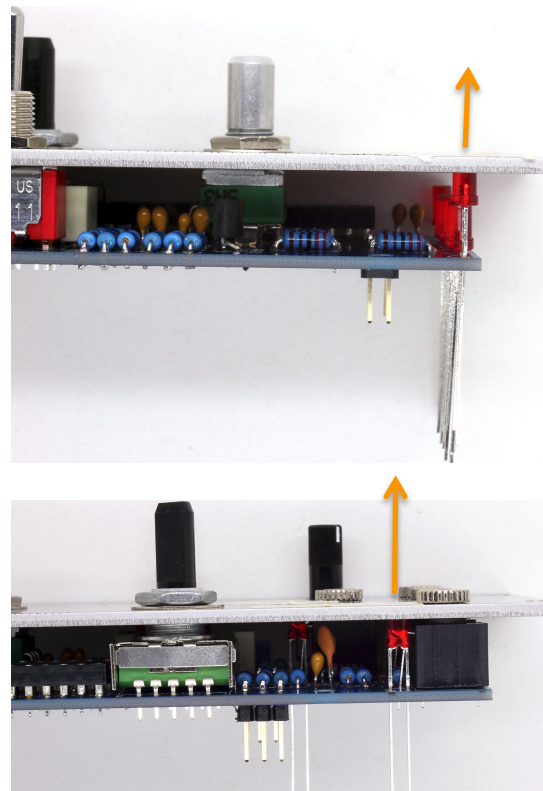



47.

Now with the panel holding everything correctly aligned finally solder all the pots, switches, jacks and LEDs.

Double check all solder joints! There are **45** to do all at once.

You are now finished soldering. Shut off your iron!

Green Rotary switch – 7 solder joints

Red Toggle switch – 3 solder joints

Green Pot – 5 solder joints

Blue Pot – 5 solder joints

LEDs – 10 solder joints in total

Jacks – 15 solder joints in total

48.

Next you will remove the metal panel and fit the two remaining IC's required on this PCB as shown.

NOTE – Orientation is vital!

NOTE! You will need to bend the pins on the IC inwards slightly so they are at 90 degrees to the body of the chip. They will come slightly splayed out. This can be done safely by clamping the 4 pins in a pair of pliers (not the cutting edge near the pivot joint though!) and very gently bending inwards together. Repeat for the other side.

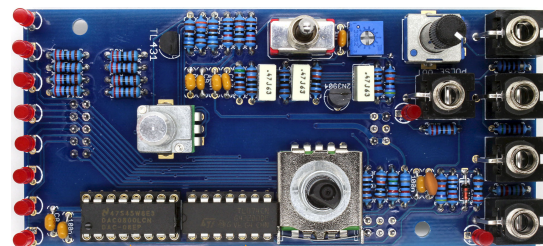

DAC0800 TL074

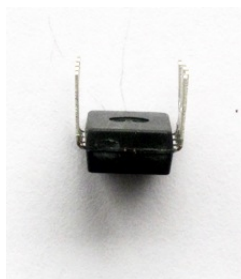
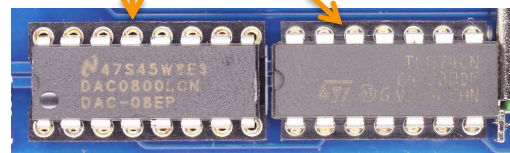



49.

Next mate the two boards together as shown. Secure with two of the remaining M3 screws

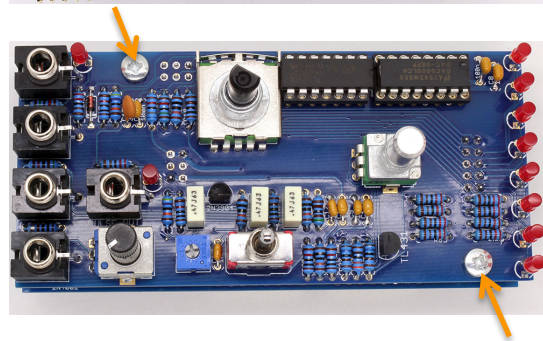
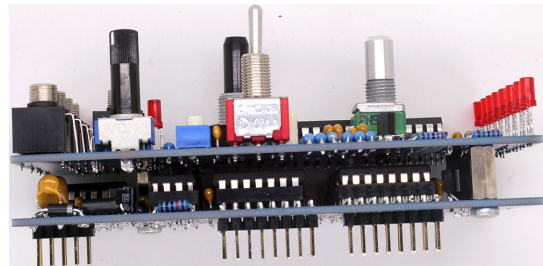
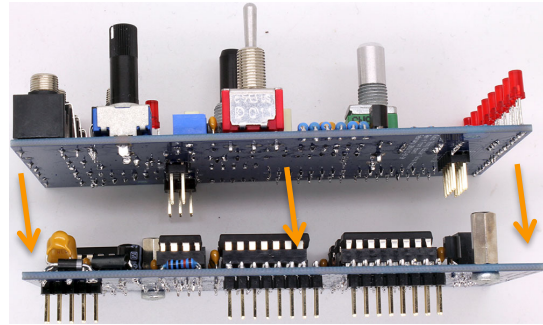

50.

Now finally put the metal panel onto the top PCB and secure all the remaining nuts and washers.

Put the two knobs on.





51.

Attach the power cable like so with the red stripe down, at the end of the power connector indicated on the PCB with 'RED'

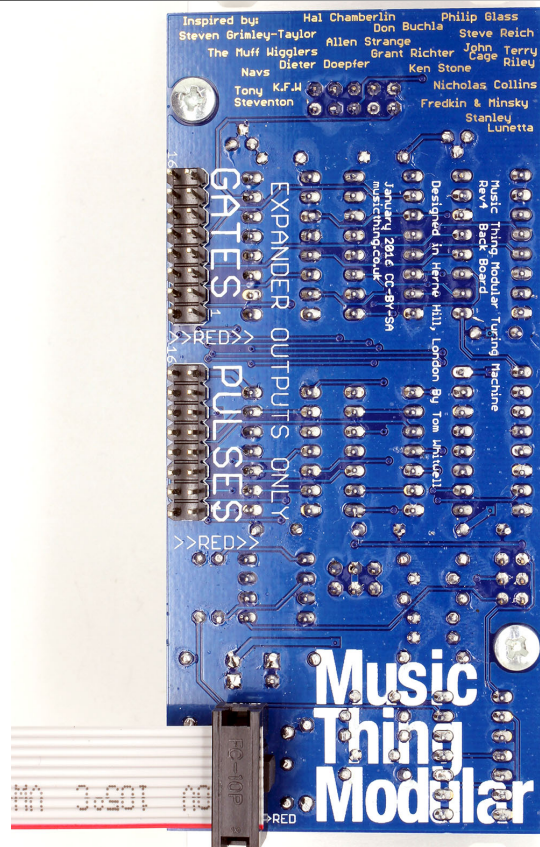

52.

You are now ready to power up and calibrate.

Complete your setup by following this video - <https://vimeo.com/163160088>

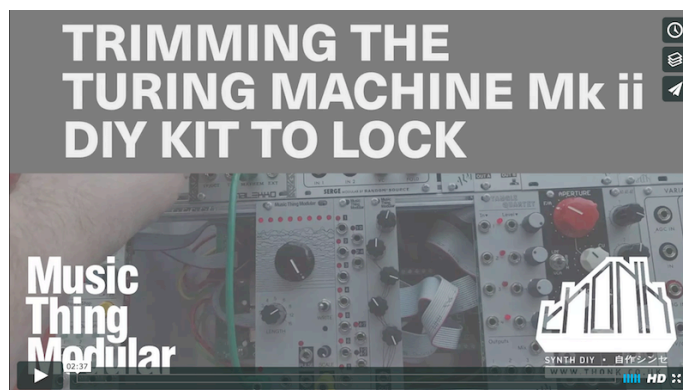

For all technical support please create a Github account and log an issue here - <https://github.com/TomWhitwell/TuringMachine/issues>

Chat about the build here – <https://www.muffwiggler.com/forum/viewtopic.php?t=159116>