



OVERVIEW

For the most recent version of this document please visit

<https://www.thonk.co.uk/documents/gbox>

This document has hi-res images. **ZOOM IN** for a closer look



All Thonk kits are sold under our standard Terms and Conditions - <http://www.thonk.co.uk/faq/>

DIY INSTRUCTIONS

This document gives detailed instructions that assume you have purchased a complete kit from www.thonk.co.uk. It also assumes no previous knowledge of electronics. To learn to solder try http://youtu.be/l_NU2ruzyc4 and the **Adafruit guide to excellent soldering** – <http://bit.ly/1l77tF4>

Watch and understand that whole YouTube video! If you're not achieving the results shown in the video then you need to buy new tools or seek advice. You will not end up with a working module otherwise.

TOOLS REQUIRED

Soldering iron, snipe nose pliers, wire strippers, small flat head screwdriver and diagonal cutters AKA snips AKA side-cutters. A Digital Multimeter is always helpful for checking for bad solder joints and continuity. Thonk sell a range of inexpensive tools here - <http://bit.ly/1jxqF3n>



SOLDER JOINTS

Your solder joints should look like those shown as 'OK' below, they should have that neat conical shape on **BOTH sides of the PCB**. If they don't look the same on both sides then stop! Work out why from the soldering guides linked and don't continue until you are getting those results.

This isn't just OCD talking, you are very likely to end up with a destroyed, damaged or defective unit if you're not hitting that standard.

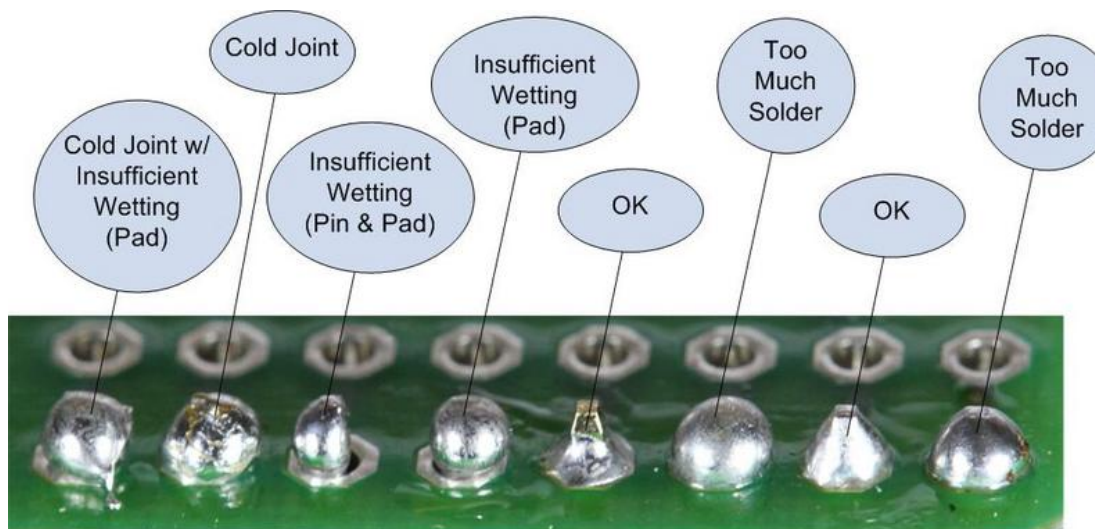

This photo is from the **Adafruit guide to excellent soldering** - <http://bit.ly/1jxqF3n> and is reproduced under an Attribution-Sharealike creative commons license - <http://creativecommons.org/licenses/by-sa/3.0/>



IMPORTANT!

Before you start soldering check the PCB version you have

You can do this by looking at the top PCB board - the PCB where the pots and jacks will go.

This build document is for the PCB version where the Top Board is called: 'Top Board version 5' (like in the picture below).

If there is not a version number after the text, then please use the other build document, found here: www.thonk.co.uk/documents/gbox/lollipop

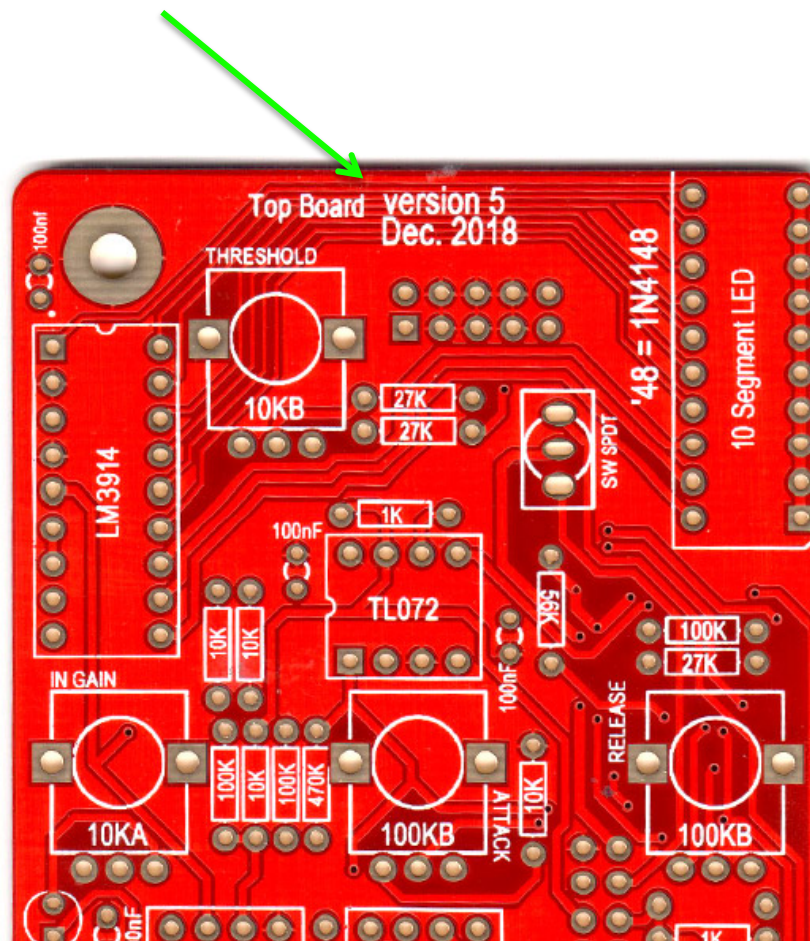



LOLLIPOP BUILD INSTRUCTIONS

1.

There are two PCBs used in this build - they are referred to as the top board and the bottom board. They can be identified by locating the text on each PCB as shown.

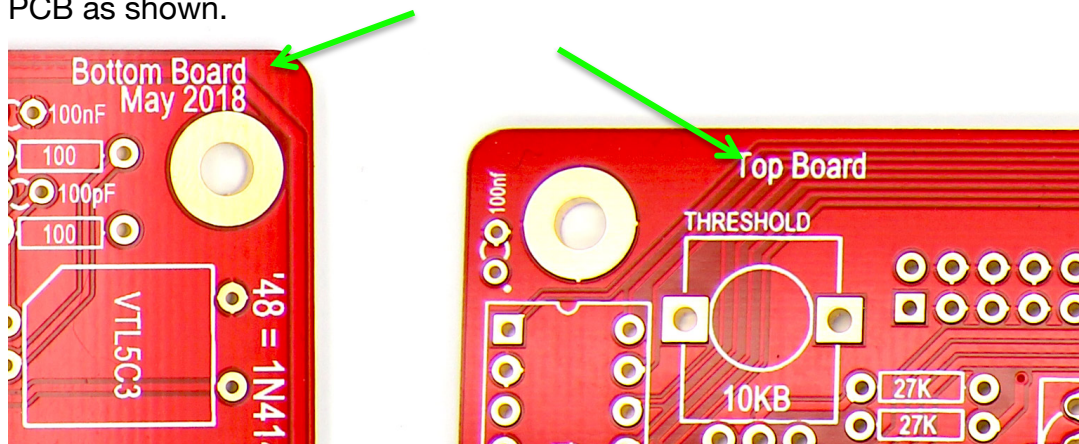

2.

Start by emptying the bag containing the two PCBs – this will also have the resistor bags containing the 56K resistors and single 330K resistor.

There are some instructions printed on the PCB bag related to the top PCB – we will now follow them.

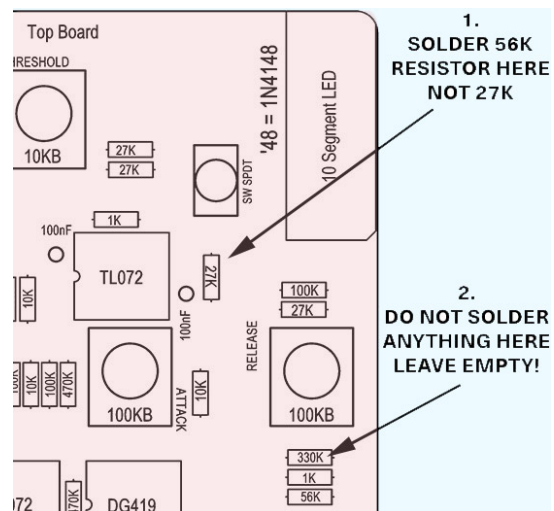



3.

Start by soldering the 56K resistors.

There are seven 56K resistors in total but one of them should be soldered into the PCB where it says 27K as shown.

Top Board

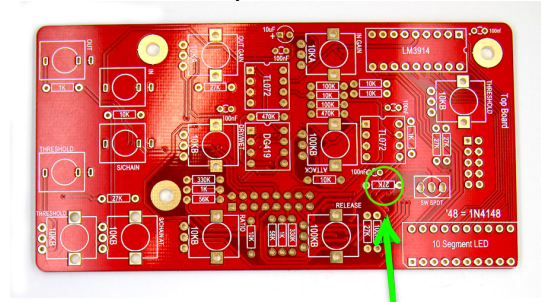

56K goes here

4.

Once all seven 56K resistors have been soldered the PCBs should look as pictured.

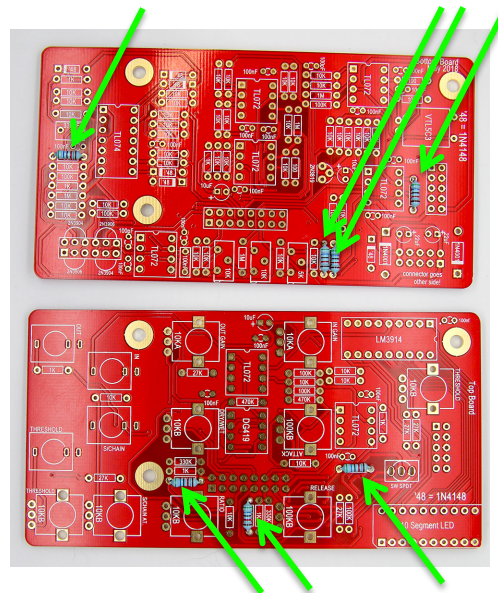

5.

Next we will solder the single 330K resistor onto the top board as shown

NOTE! There are two positions for 330K but one should be left empty.

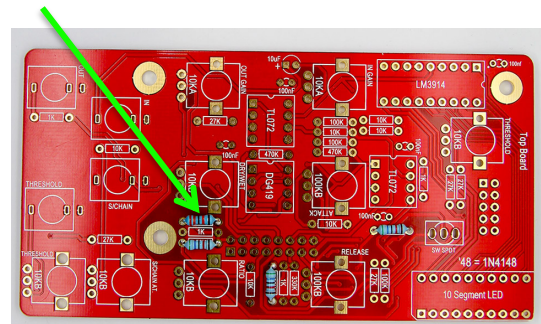



6.

Now you can go ahead and solder all the rest of the resistors for the top and bottom boards. All resistors from this point onwards should be soldered with exactly the values as shown on the PCB legend

It is recommended you do this gradually – one value at a time.

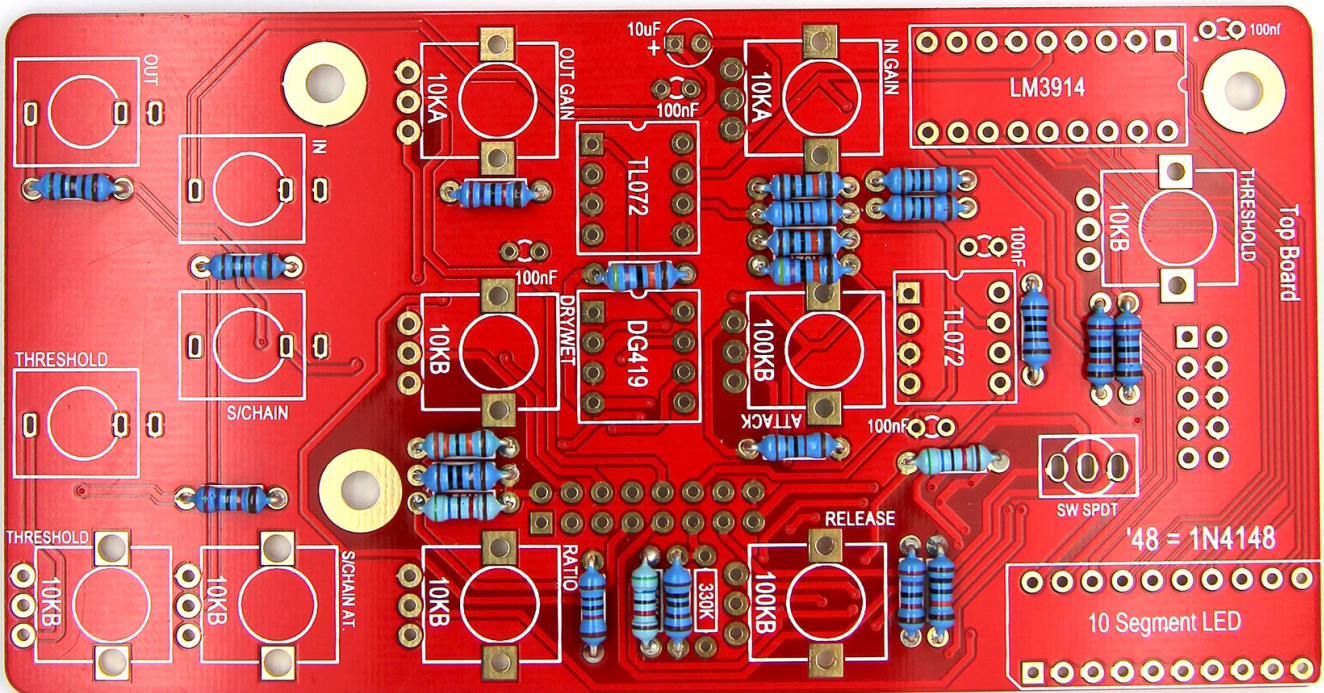
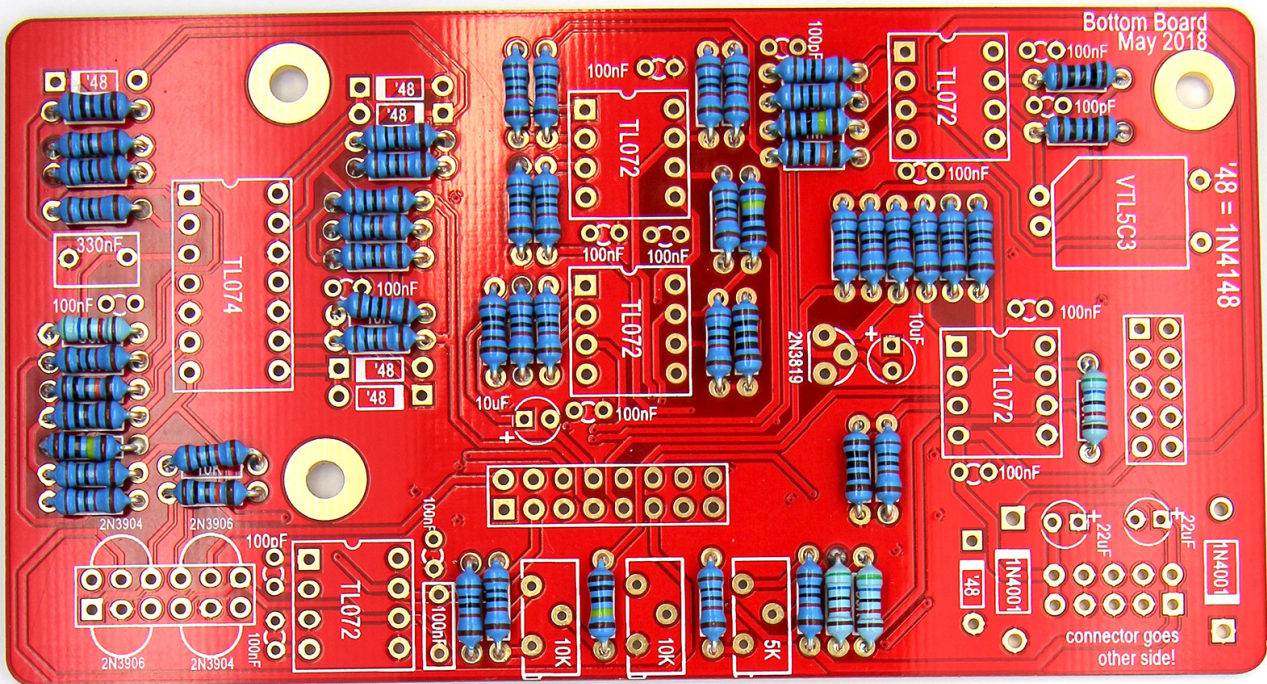



7.

Next we're going to solder in the diodes, starting with the 6 x 1N4148. These are orange coloured with a black stripe and labelled on the PCB as '48.

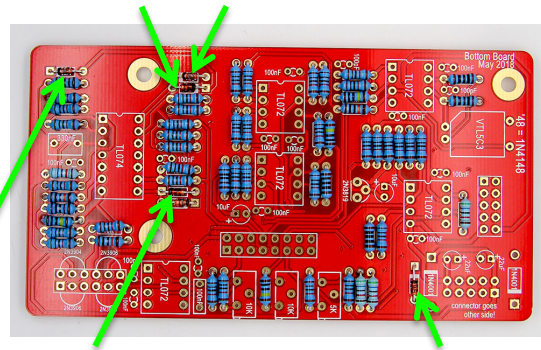

NOTE: Take care with the orientation of the black stripes on the diodes – these should match the thick white lines on the PCB silkscreen.

NOTE! Do not heat the diodes excessively or you will damage them, you should be aiming to solder quickly and neatly.

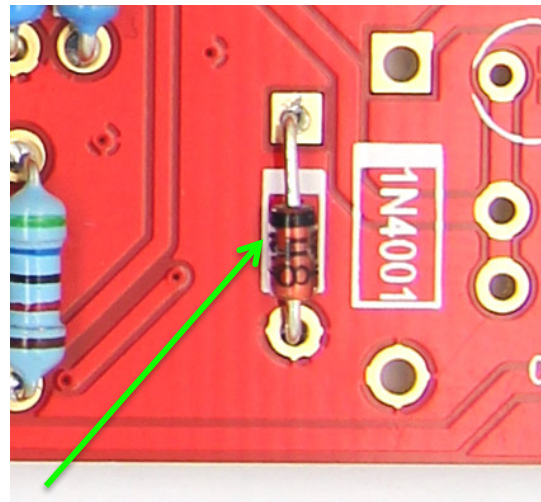

8.

Next solder the two 1N4001 diodes. These are black with a silver stripe

NOTE: Take care with the orientation of the silver stripes which should match the thick white lines on the PCB silkscreen.

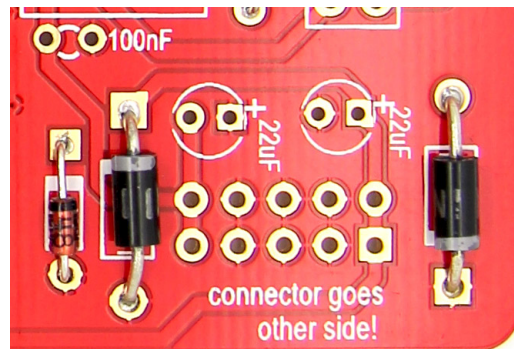

9.

Next solder in the three 100pF capacitors on the bottom board.

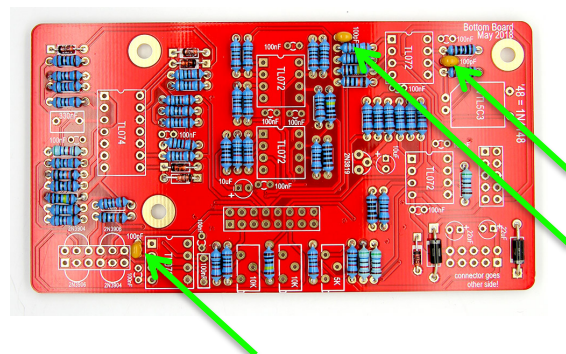



10.

Now solder in the IC sockets on both PCBs. Make sure these sockets are soldered flush and perpendicular to the PCB surface.

The notch on each socket should match the PCB silkscreen as shown.

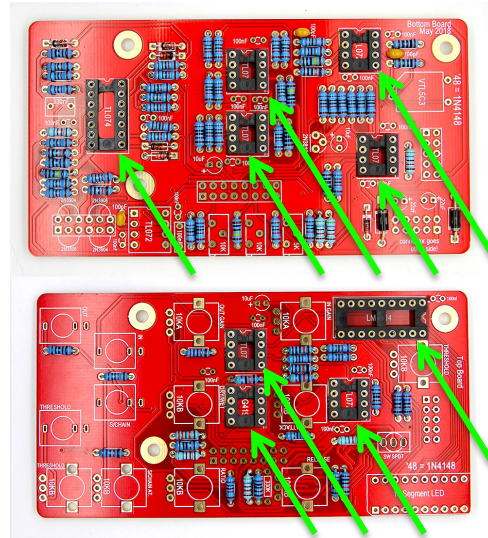

11.

Next solder in the seventeen ceramic 100n capacitors

Note! there are two different types of 100n capacitor in this kit. Do not solder a ceramic cap into the position below.

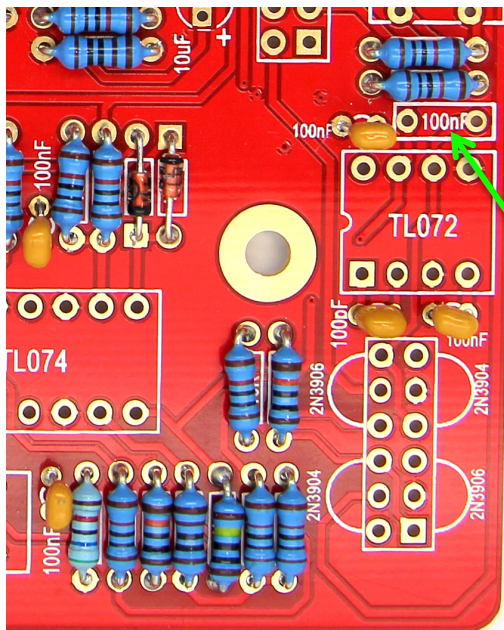
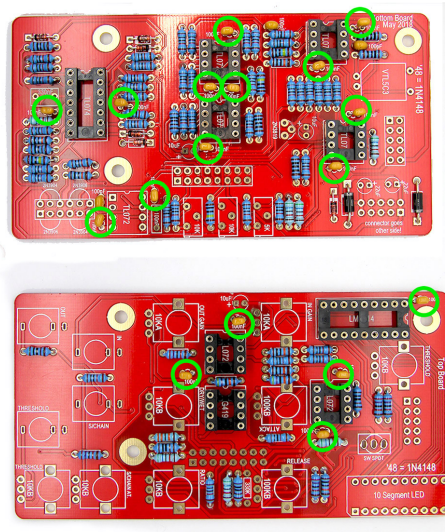

DO NOT solder a ceramic cap here



12.

Next identify the 100n and 330n box film capacitors. These are located in the capacitor bag.

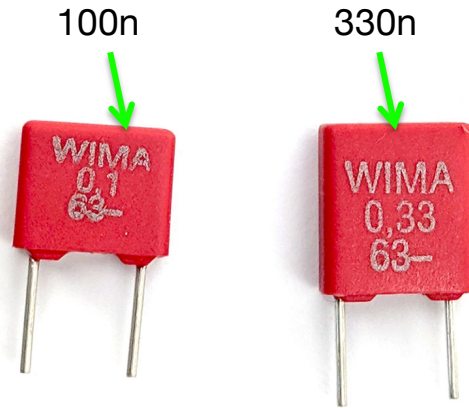

13.

Now take the 100n red box capacitor and solder it into position

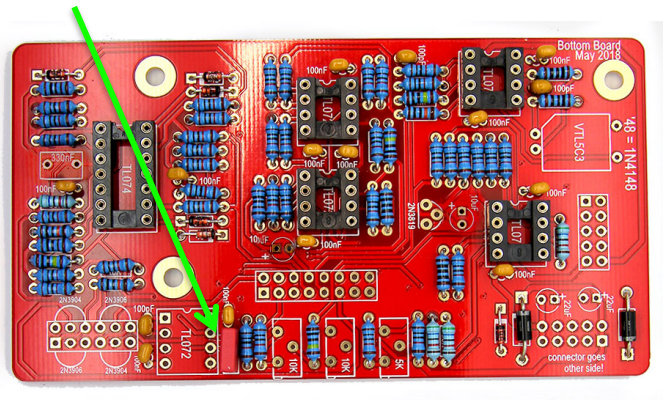

14.

Next solder the 330n red box capacitor.

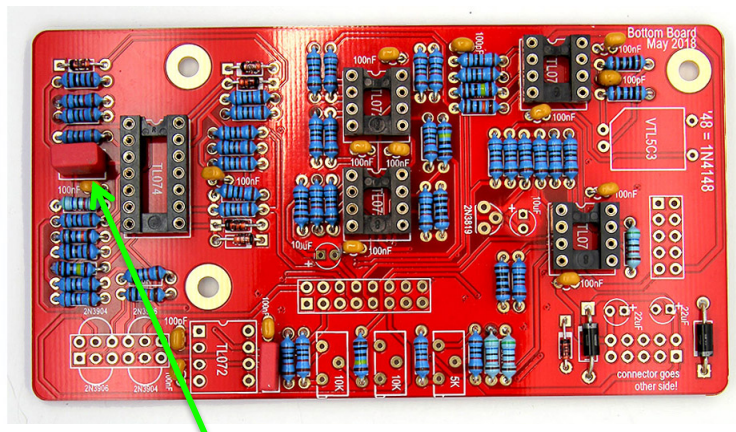



15.

Now solder in the three 10uF Electrolytic Capacitors.

NOTE! Orientation is vital on this part. The grey stripe and shorter leg signify the negative side of the capacitor, the longer lead of the component should go into the hole marked + on the PCB.

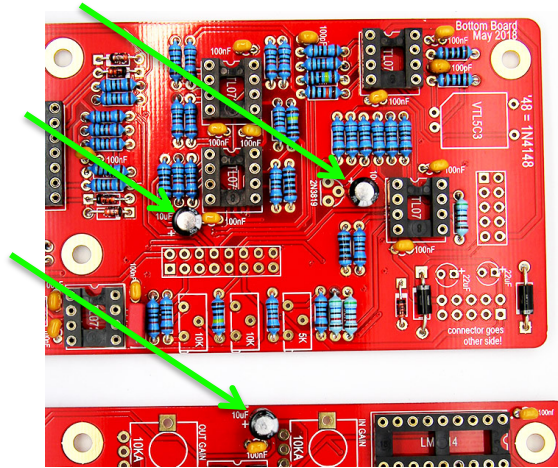
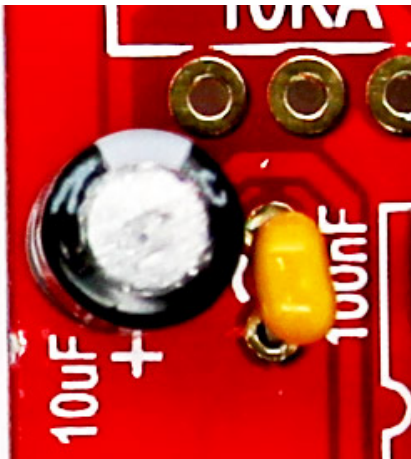

16.

Next solder in the 10 pin male power header on the back of the bottom board as shown.

NOTE: Make sure this header is soldered on the opposite side of all other components as shown in the picture.

Bottom Board

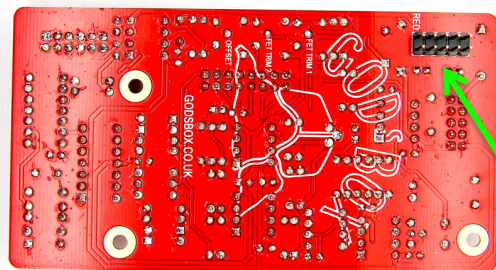

17.

Next solder in the two 22uF Electrolytic Capacitors

NOTE! Orientation is vital on this part. The grey stripe and shorter leg signify the negative side of the capacitor, the longer lead of the component should go into the hole marked + on the PCB

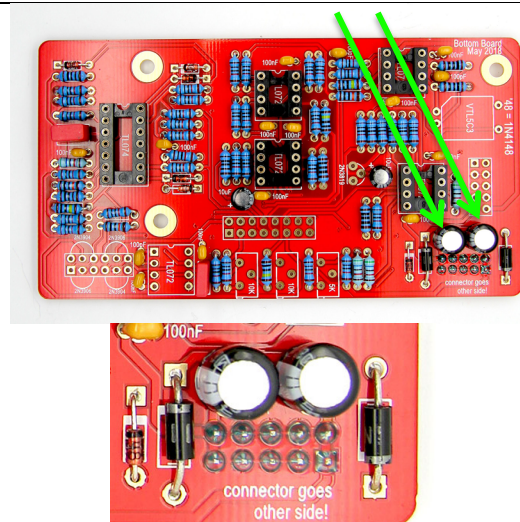



18.

Now solder in the two 2N3904 transistors

NOTE! Orientation matters – be sure to match the curve of the body to the PCB silkscreen.

Do not heat this part excessively or you will damage it, you should be aiming to solder quickly and neatly.

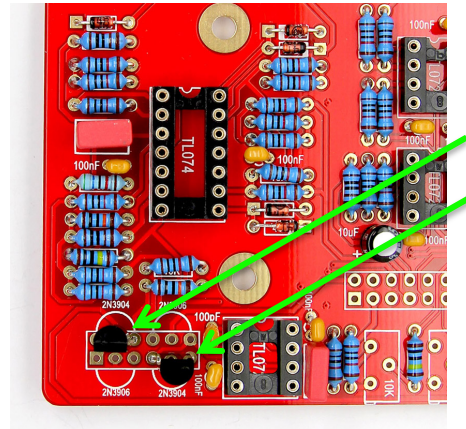

19.

Now solder in the two 2N3906 transistors

NOTE! Orientation matters – be sure to match the curve of the body to the PCB silkscreen.

Do not heat this part excessively or you will damage it, you should be aiming to solder quickly and neatly.

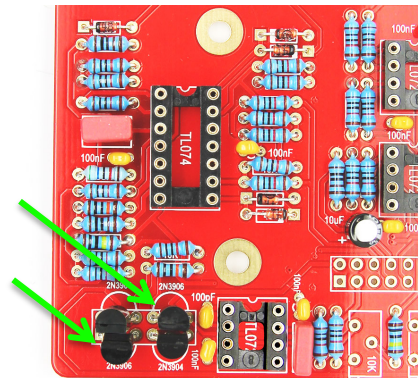

20.

Now solder the single 2N3819 transistor

NOTE! Orientation matters – be sure to match the curve of the body to the PCB silkscreen.

Do not heat this part excessively or you will damage it, you should be aiming to solder quickly and neatly.

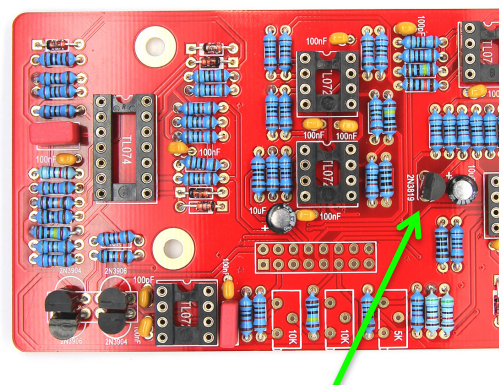



21.

Next solder the single 5K trimmer and the two 10K trimmers.

NOTE! Orientation matters - make sure the brass screws are pointing **away** from the centre of the PCB.

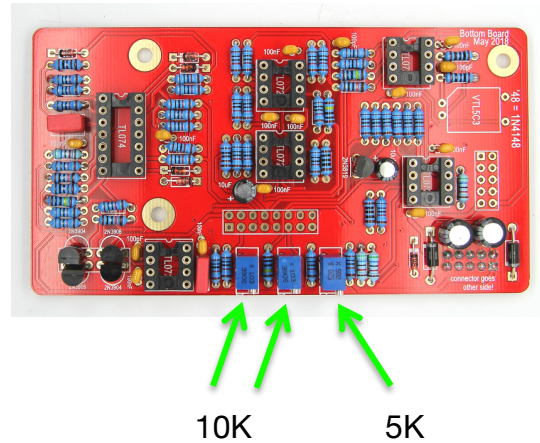

22.

Next take the Vactrol and solder into place as shown. The orientation of the 4 pins is vital. The Vactrol should be placed completely flat to the top surface of the PCB.

NOTE! Do not heat this part excessively or you will damage it, you should be aiming to solder quickly and neatly.

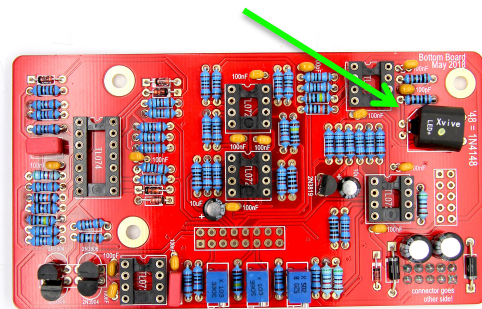

23.

Next place and solder the remaining 2x5 male header and the 2x8 male header to the bottom board - these are placed on the same side as the resistors and capacitors as shown.

These should be soldered flush and perpendicular to the PCB surface.

Bottom Board

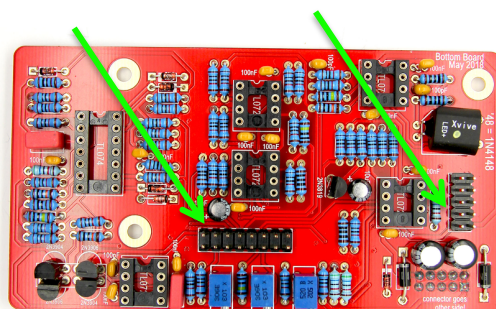

NOTE! Don't solder these headers to the other side of the board like the power header you already soldered!



24.

Now switch to the other PCB and place but **DO NOT SOLDER** the 2x5 and 2x8 (or two 1x8) female headers onto the top board. The female headers sit on the opposite side to all other components.

Before soldering these headers – connect them to the male headers on the bottom PCB. Once you have the PCBs connected nicely with the headers sitting flush you can then solder them in place.

Now is also a good time to screw the hex spacers onto the top board.

SWITCH TO OTHER PCB!

Top Board

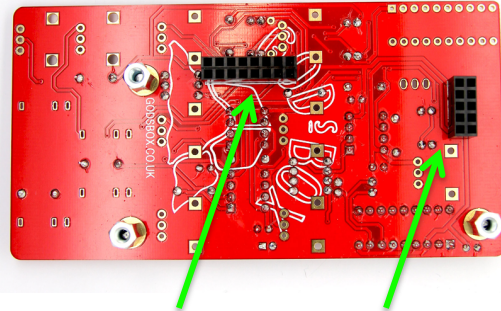

25.

Now disconnect the PCBs and place but **DO NOT SOLDER** the pots, jacks, LED bar and switch.

Be sure to match the pot values to the PCB silkscreen as shown. Screw just one of the nuts onto the switch - do not use the switch washer.

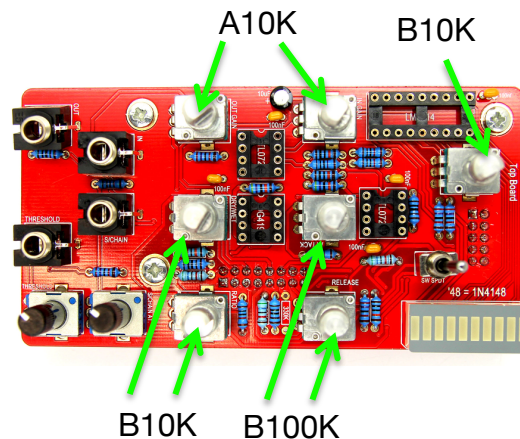

26.

NOTE! Orientation matters for the LED bar. One of the corners is flattened - make sure you align this with the PCB silkscreen. Now you can carefully place on the front panel and screw the nuts and washers onto the pots, jacks and switch.

NOTE: Read the next step before soldering the LED bar

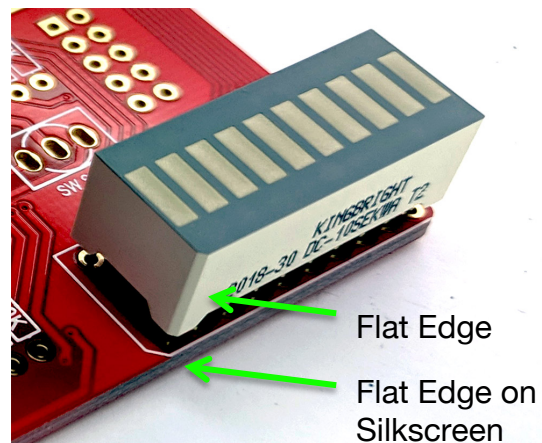



27.

The module looks much nicer when the LED bar is soldered flush to the front panel. Secure the panel by screwing a few nuts and washers onto the pots, then make sure the LED bar is lined up straight to the panel hole.

It's a good idea to solder a single edge pin of each row and then check that it's still lined up straight before proceeding with the rest of the solder joints – this way you can still re-position it if required.

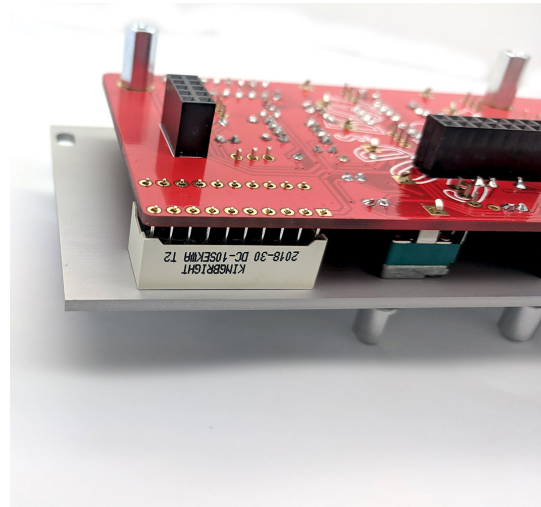

28.

Now add a few nuts to the jacks and switch to hold the panel in place and then solder in all the pots, jacks and switches.



29.

Now remove the panel and fit all the ICs into their sockets as shown

NOTE! Orientation is vital for all ICs

For the seven TL072 make sure the black circle on the top face of the IC is facing the end with the notch in the IC socket as pictured.

For all other chips make sure the notch in the chip is at the side with the notch in the IC socket.

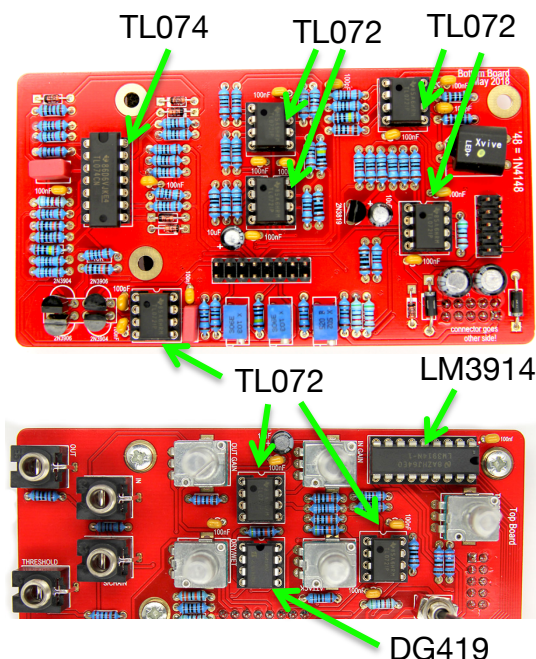



30.

Now connect the two PCBs together and secure the three spacers with screws.

Then you can replace the frontpanel and screw everything on and place the seven knobs onto the pots.



31.

The module is now complete. Affix the power cable as shown with the red stripe down. The red stripe should always be facing the PCB text label 'RED'

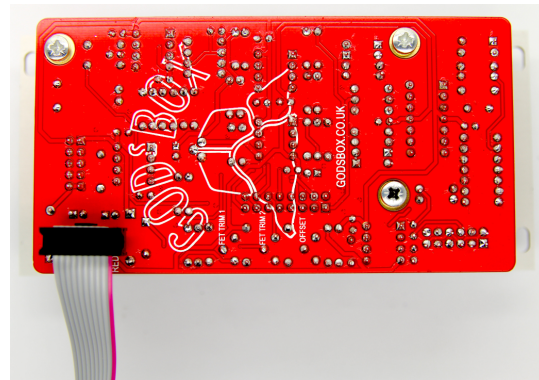

The trimming and calibration process is detailed in the God's Box documentation linked below.

32.

The Lollipop calibration instructions can be found here:

www.thonk.co.uk/documents/gbox/lollipop/lollipop%20calibration.pdf

More info on God's Box modules can be found at <http://godsbox.co.uk>