

Ljunggren Audio Roll Your Own Trig Xpander

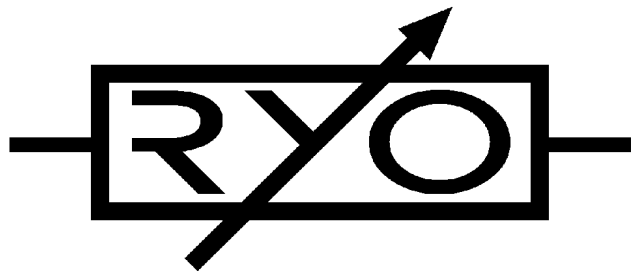

Version: Trig Xpander 1.1

[For version 1.2 follow this link.](#)

Bills Of Material

PCB1

TYPE	PART	VALUE	PCS	NOTE
LED	L1,L2,L3,L4,L5,L6,L7,L8,L9	Orange	9	3mm
Diode	D10	1N4148	1	
Resistor	R9,R10	2.2K	2	LED resistors
Resistor	R7	1M	1	
Resistor	R8	1K	1	
Jack	J1,J2,J3,J4,J5,J6,J7,J8,J9	3.5mm	9	PJ301BM

PCB2

TYPE	PART	VALUE	PCS	NOTE
Capacitor	C2,C3,C4,C5,C9	100nF	5	X7R 2.5mm
Capacitor	C8	33nF	1	C0G 2.5mm, Timing cap.
Electrolytic	C1	10uF	1	2mm pin pitch, 5mm dia, 5mm height
Diode	D1	SB130	1	or 1N5818. Power polarity protection.
Diode	D2,D3,D4,D5,D6,D7,D8,D9	1N4148	8	
Resistor	R2,R3,R4,R5,R6	33K	5	
Resistor	R1	10R	1	
IC Socket	IC1	8 pin	1	
Timer	IC1	NE555	1	Or TLC555
IC Socket	IC2	16 pin	1	
CD4xxx	IC2	CD4051	1	Break-before-Make version like TI CD4051BE.
Resistor network	RN1,RN2	1M	2	SIL8 with 4 isolated resistors. Not sensitive to mounting direction.
Resistor network	RN3,RN4	1K	2	SIL8 with 4 isolated resistors. Not sensitive to mounting direction.
Trimmer	TRIM1	500k	1	Trig length adjustment.
Transistor	Q1,Q2,Q3,Q4,Q5,Q6,Q7,Q8,Q9,Q10	FJN3303R	10	Switching biased NPN transistor.
Pin strip	JP1	3 pin	1	Single row, jumper.
Expand header	IN, THRU	10 pin	2	2 rows x 5 pins
Power header	POWER	10 pin	1	boxed

OTHER

TYPE	PART	VALUE	PCS	NOTE
Faceplate			1	PCB material (FR4), black, 2mm
PCB	PCB1,PCB2		1	One PCB split into two with V-Cut.
Power cable		IDC	1	16pin – 10pin
Expansion cable		IDC	1	10pin – 10pin
Mounting screws			2	M3x6 black pozi
Jumper			1	For JP1
Pin strip	CON1,CON2	10 pin	2	Angled 90 degrees, single row. Connects PCB1 and PCB2 together.

Assembly instructions

We start with breaking the PCB into two parts with help of the V-Cut pointed out in the image below.

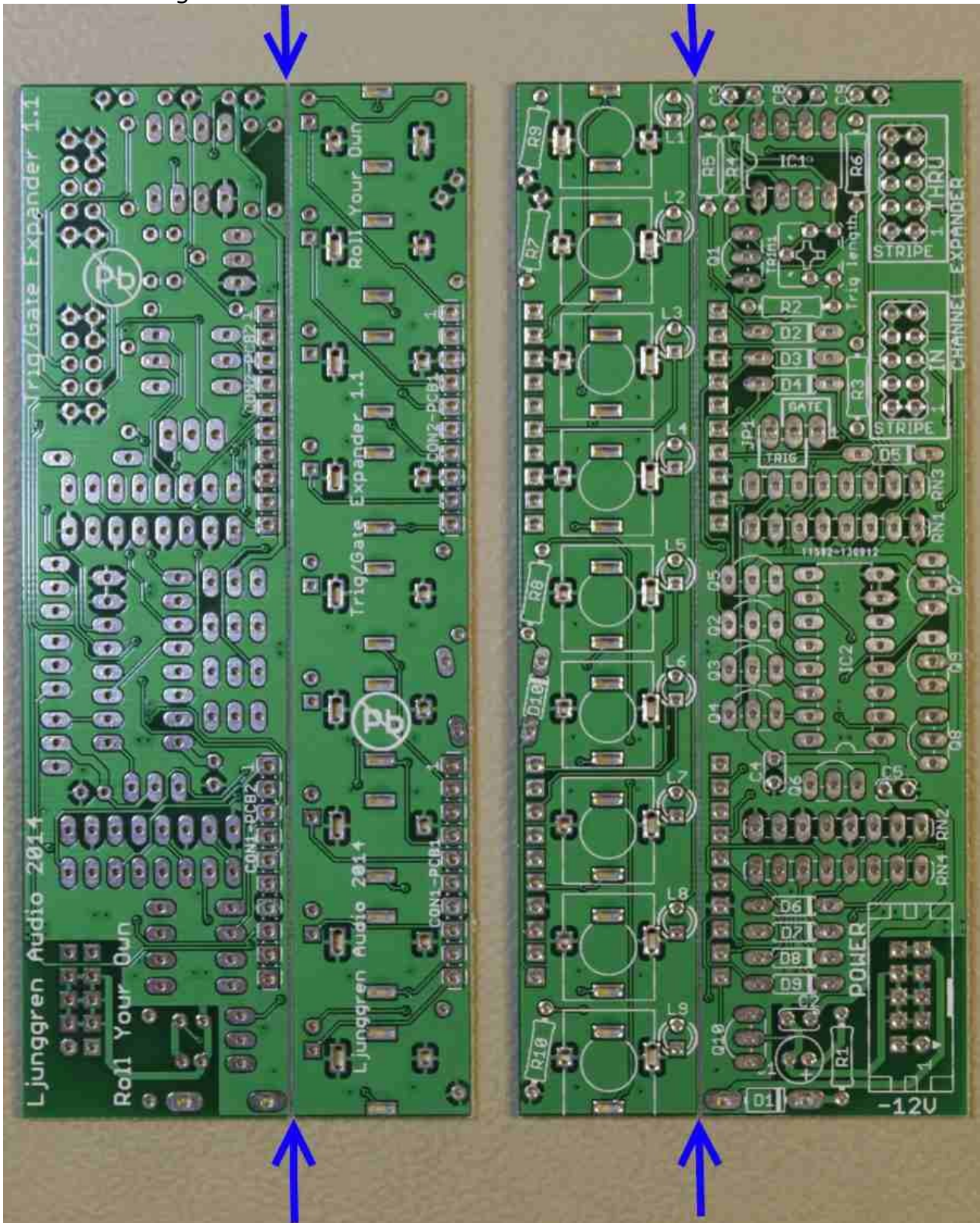

Empty PCB bottom & top.

Break it with your hands like this.

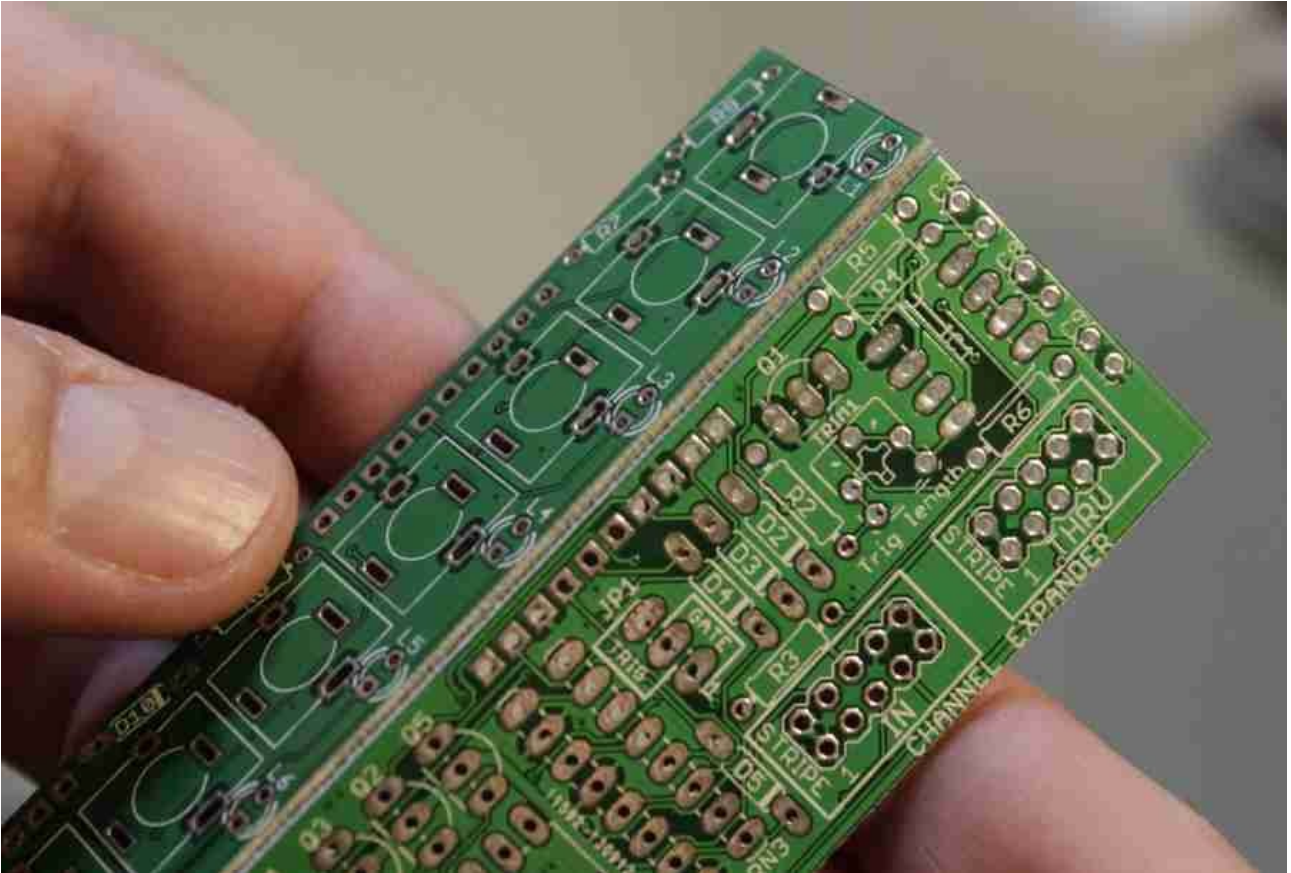

You should end up with this.

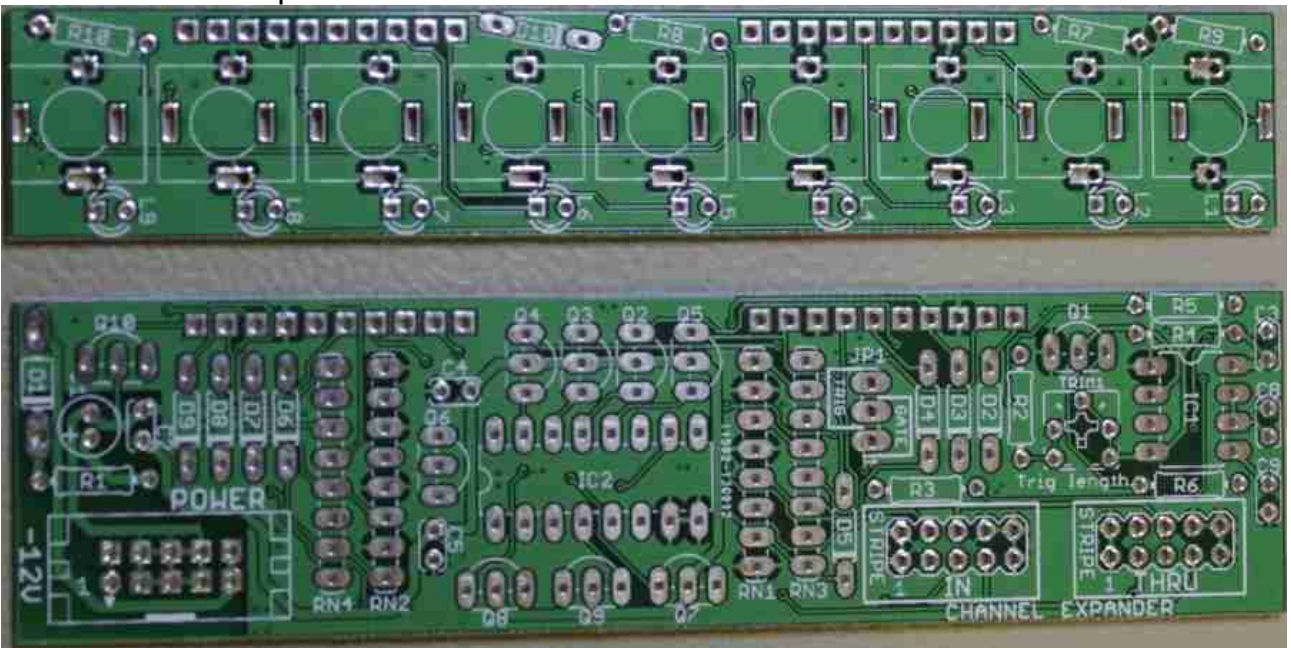

Step 1

Solder small signal diodes. Diodes are sensitive to mounting direction, the stripe on the diodes must be on the same side as indicated in the silk screen.

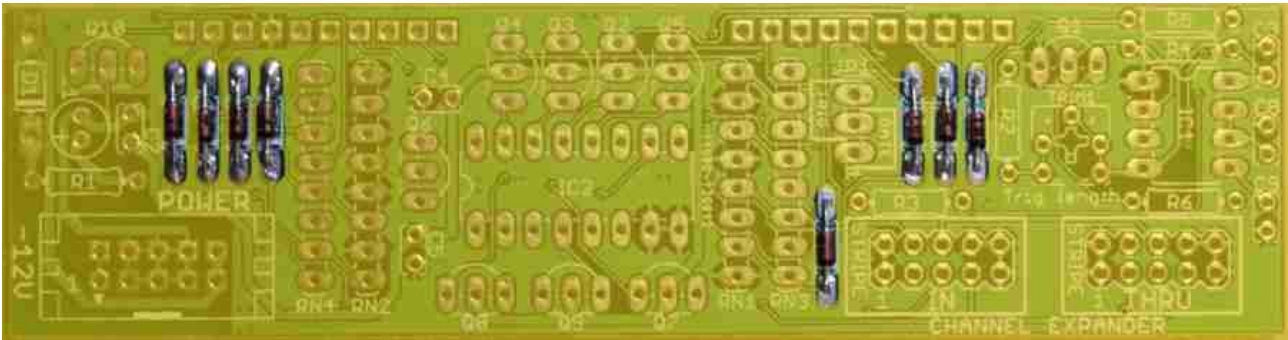

D2, D3, D4, D5, D6, D7, D8, D9 1N4148

Step 2

Solder resistors. Resistors are not sensitive to mounting direction.

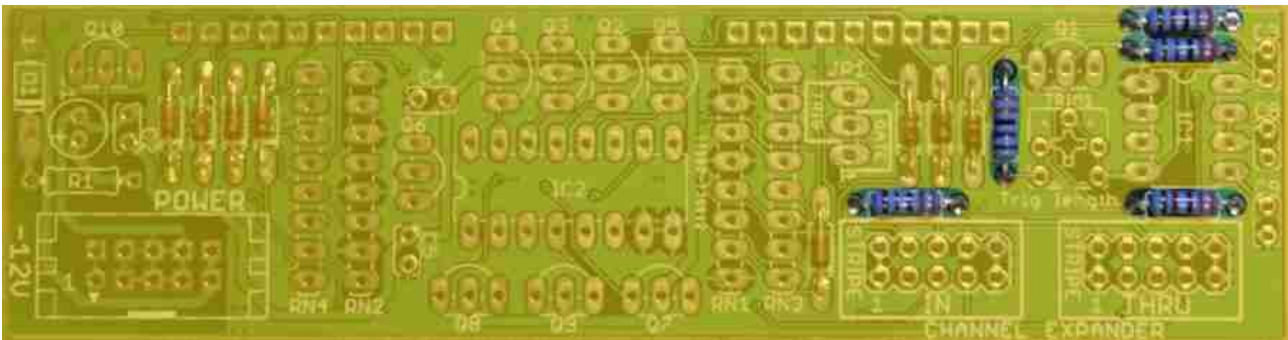

R2, R3, R4, R5, R6 33K

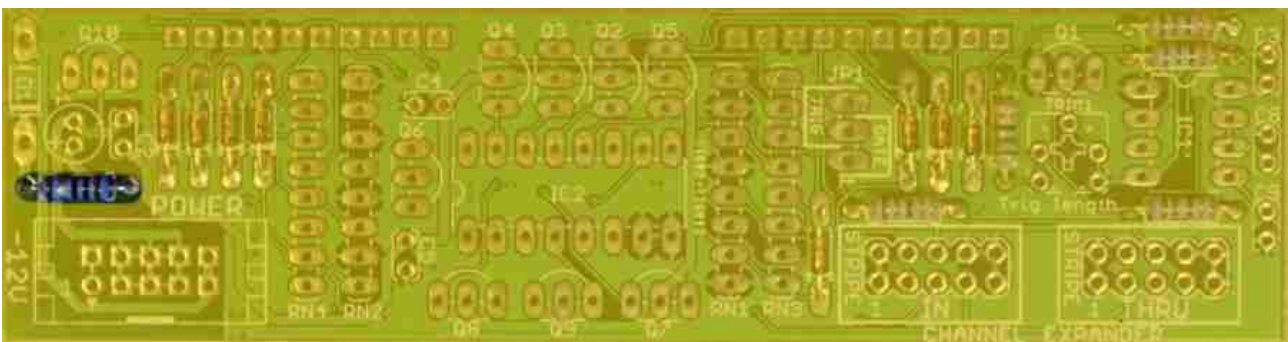

R1 10R

Step 3

Solder reverse polarity protection diode. Diodes are sensitive to mounting direction, the stripe on the diode must be on the same side as indicated in the silk screen. In the images step 4 is done before step 3 but it is better to do step 3 first.

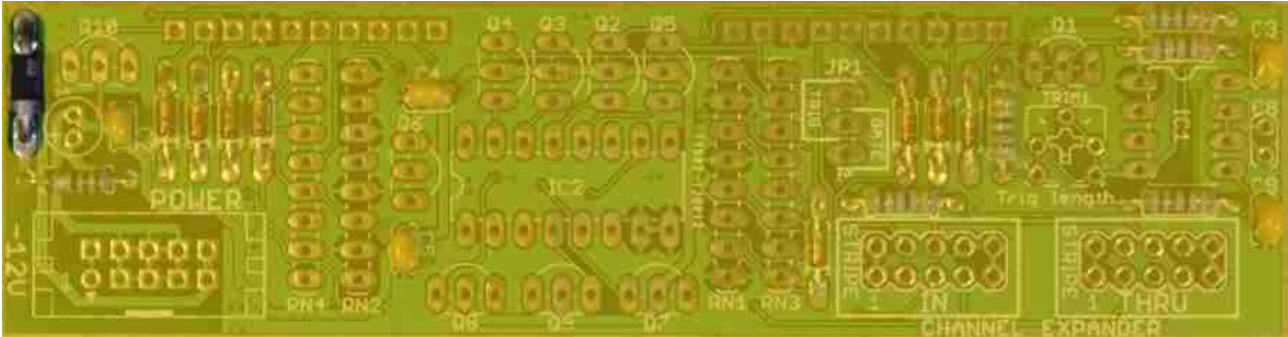

D1 SB130

Step 4

Solder ceramic capacitors. Ceramic capacitors are not sensitive to mounting direction.

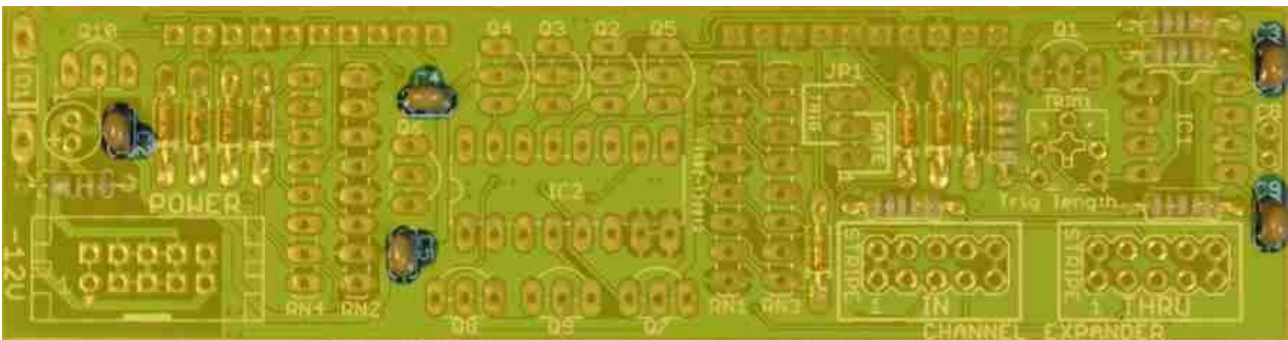

C2, C3, C4, C5, C9 100nF

We wait a little with the last ceramic cap C8 as it's taller.

Step 5

Solder IC sockets. Match the IC sockets indent (marking pin 1 side) with the silk screens.

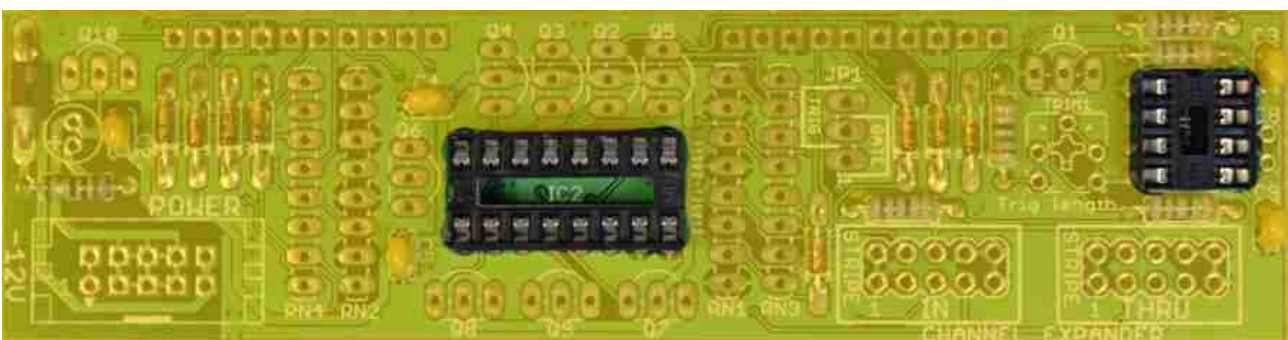

IC1 8 pin DIP socket. **IC2** 16 pin DIP socket. IC's will be mounted later.

Step 6

Solder trimmer. Only 3 of the 5 holes are used, the extra 2 holes are for fitting trimmers with different appearance.

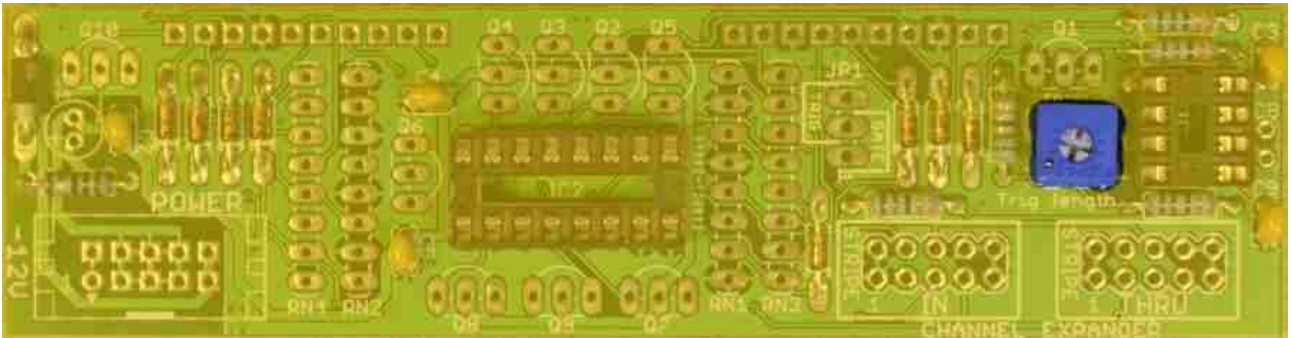

TRIM1 500K

Step 7

Solder resistor networks. This kind of resistor network is not sensitive to mounting direction.

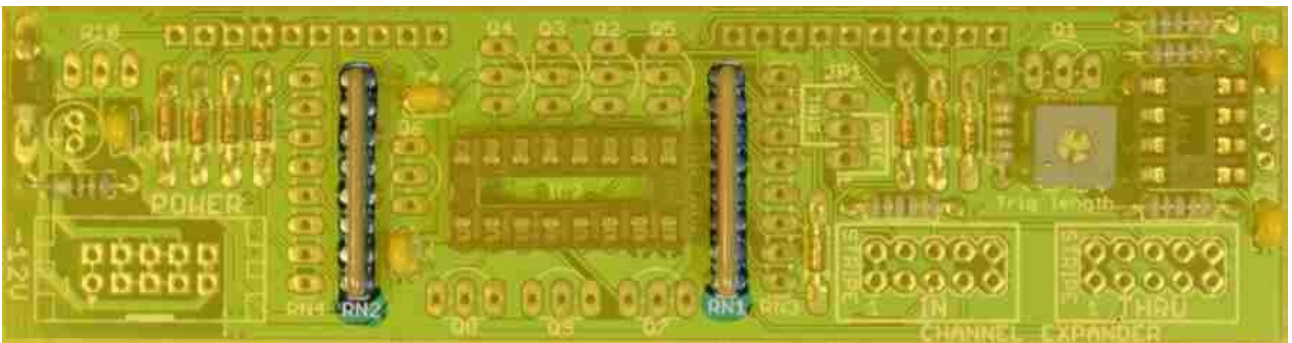

RN1, RN2 1M isolated

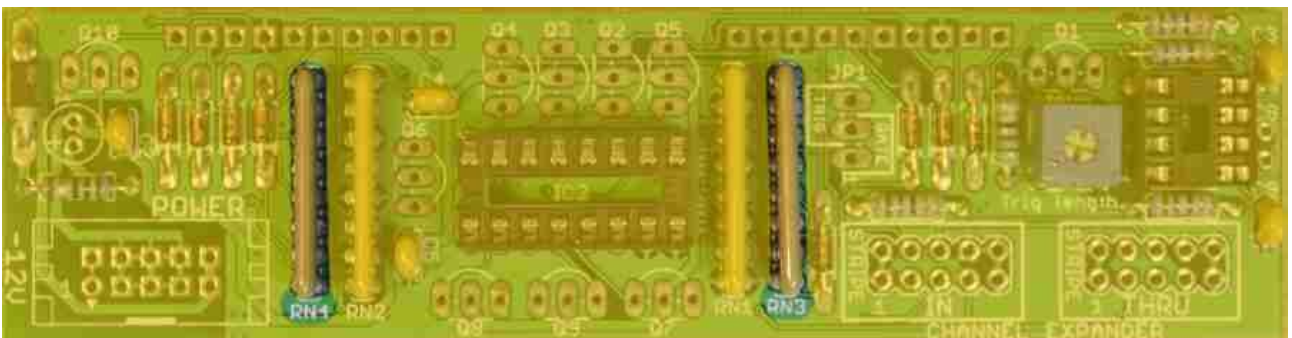

RN3, RN4 1K isolated

Step 8

Solder the last ceramic capacitor. Ceramic capacitors are not sensitive to mounting direction.

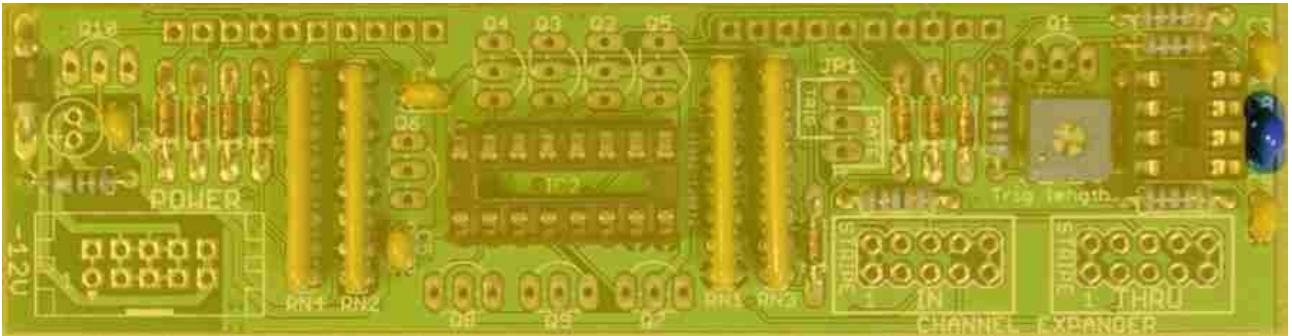

C8 33nF

Step 9

Solder Electrolytic. Long leg is + (anode).

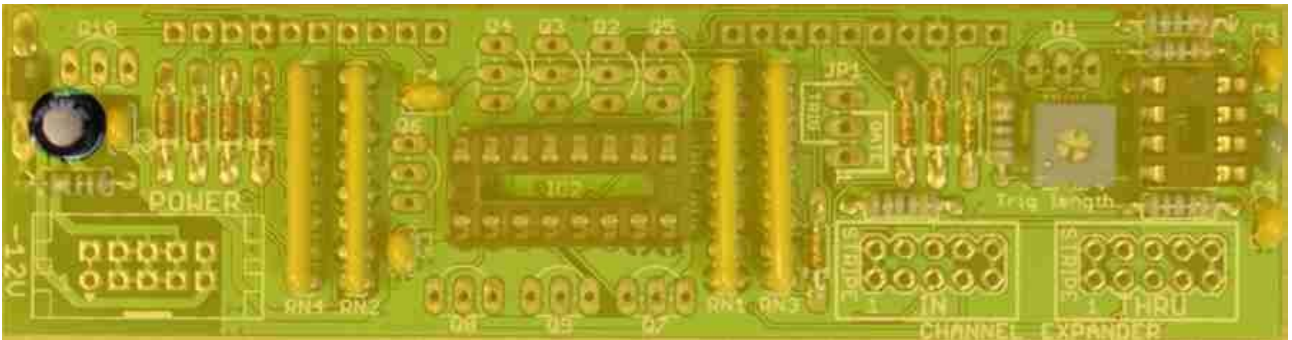

C1 10 μ F

Step 10

Solder transistors. Match the curved side with the silk screen.

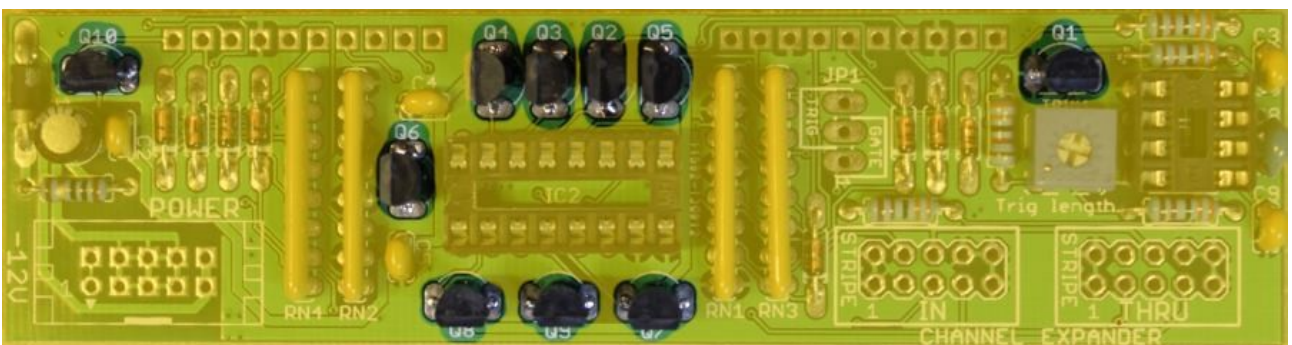

Q1, Q2, Q3, Q4, Q5, Q6, Q7, Q8, Q9, Q10 FJN3303R

Step 11

Solder expander headers. It's a good idea to take the 10-pin side of the power cable and plug it in the header you are soldering. It makes it easier to avoid heating the pins up too much and make them unaligned by moving around.

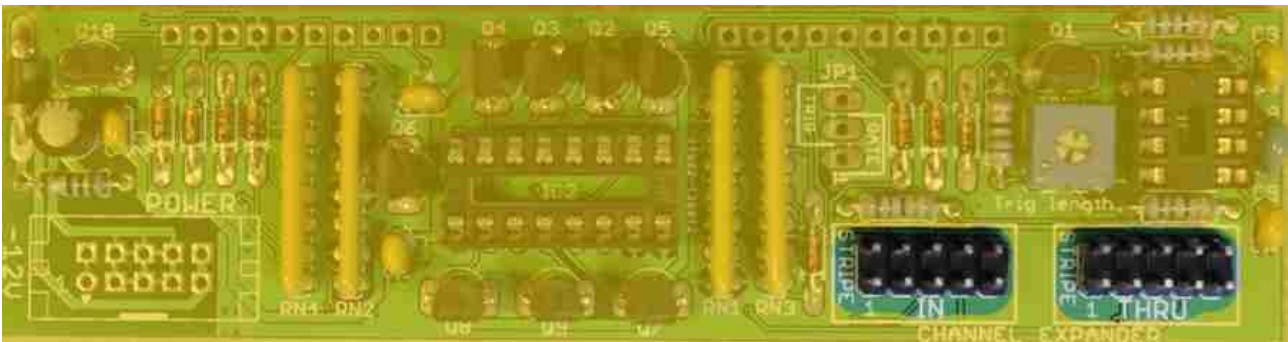

IN, THRU 10 pin open header

Step 12

Solder the 3 pin strip and place the jumper in either **TRIG** or **GATE** mode.

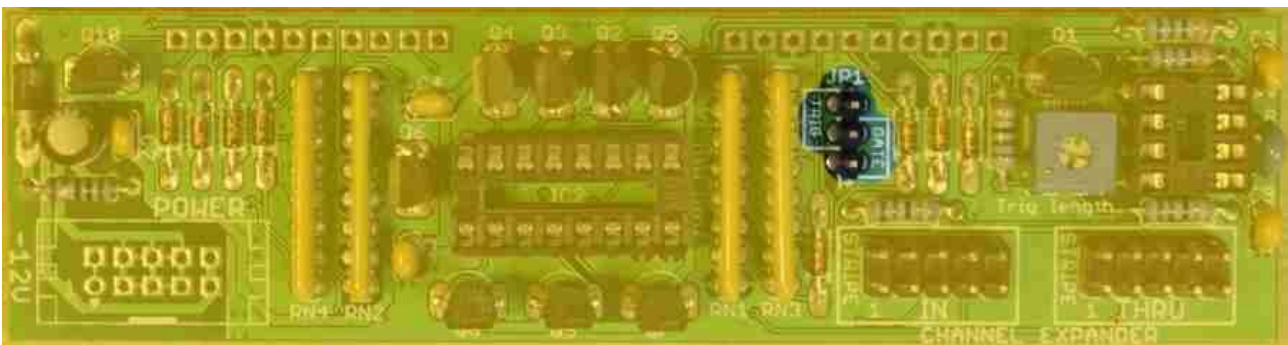

JP1 3 pin strip

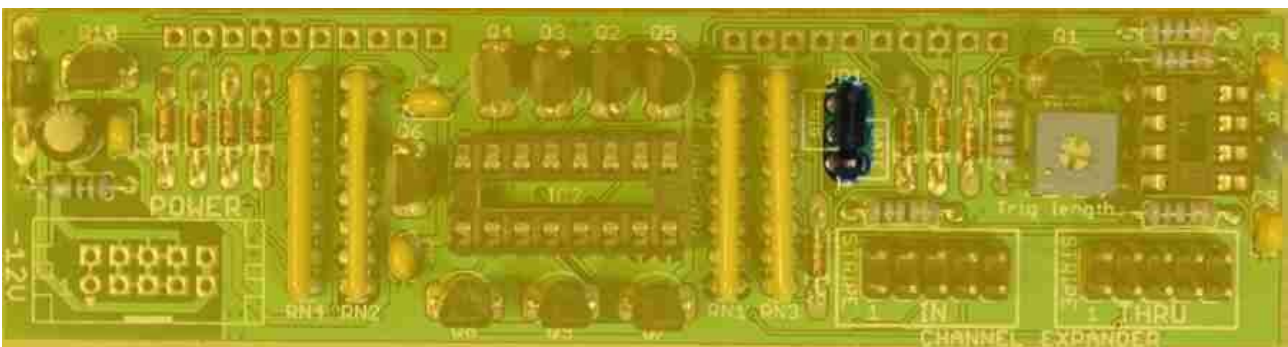

Jumper in trig mode.

Step 13

Solder the keyed boxed power header. Pay extra attention to the direction. The triangle (pin 1) must be at the -12V side. It's a good idea to use the power cable in the same way as in the previous step. In the picture below the slot opening (key) is pointed to.

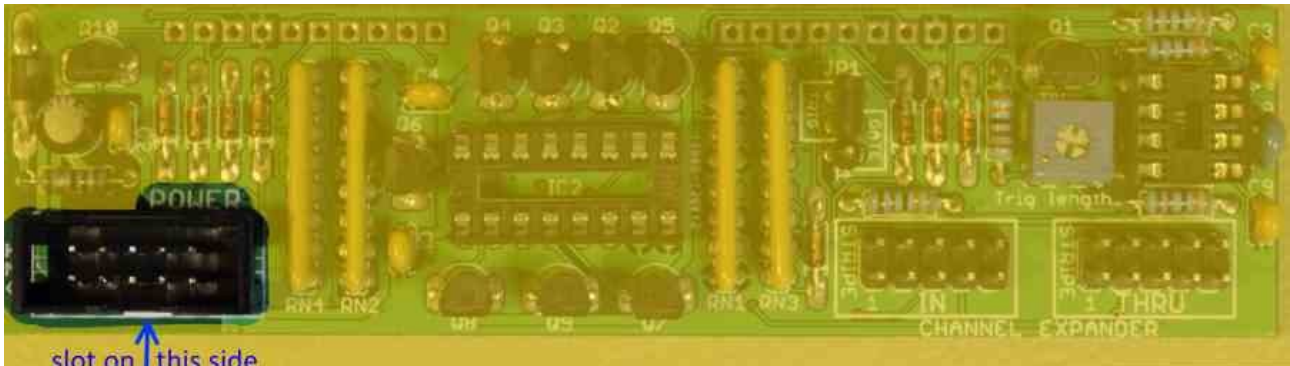

POWER

Leave PCB2 on the side. Now it's time for PCB1.

Step 14

Solder small signal diode. Diodes are sensitive to mounting direction, the stripe on the diodes must be on the same side as indicated in the silk screen.

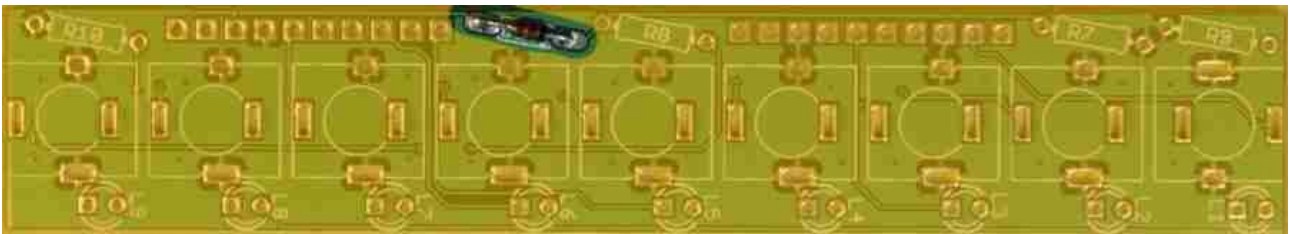

D10 1N4148

Step 15

Solder resistors. Resistors are not sensitive to mounting direction.

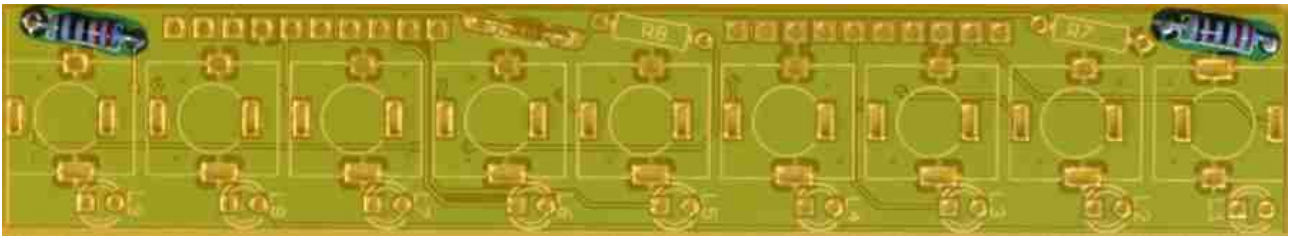

R9, R10 2.2K



R7 1M



R8 1K

Step 16

Place the jacks in their places without soldering them and mount the panel over the jacks with the help of a washer and a nut on each jack. Don't worry if the jacks twist a tiny bit in their socket while tightening the nut, this is normal, as long as it's not soldered yet it won't be stressed. Use a socket wrench to keep the risk of scratching the panel to a minimum.



Now you can solder the jacks in place.

Step 17

Place the LEDs in their position like in the pictures below. The long pin of the LEDs are anode (+) and goes in the hole with a square pad.



Turn the module around and guide the LEDs to their respective panel holes.

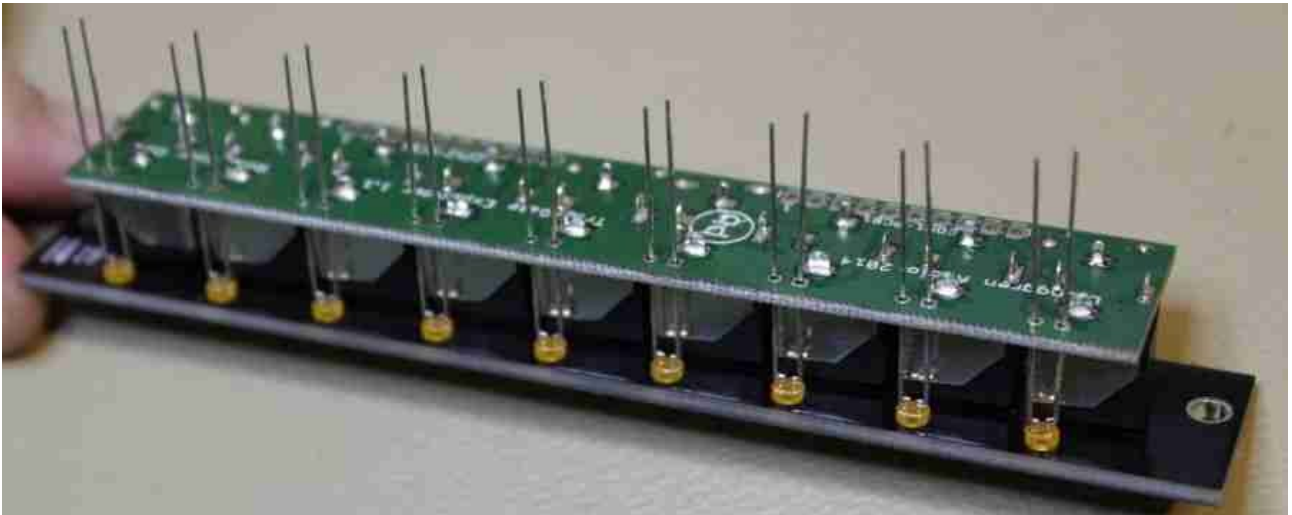

Now solder them in place.



Step 18

Solder the two angled 10 pin strips in place on PCB1 like in the picture below. Make sure the pins point towards the middle of the module and that the plastic part is in contact with PCB1.

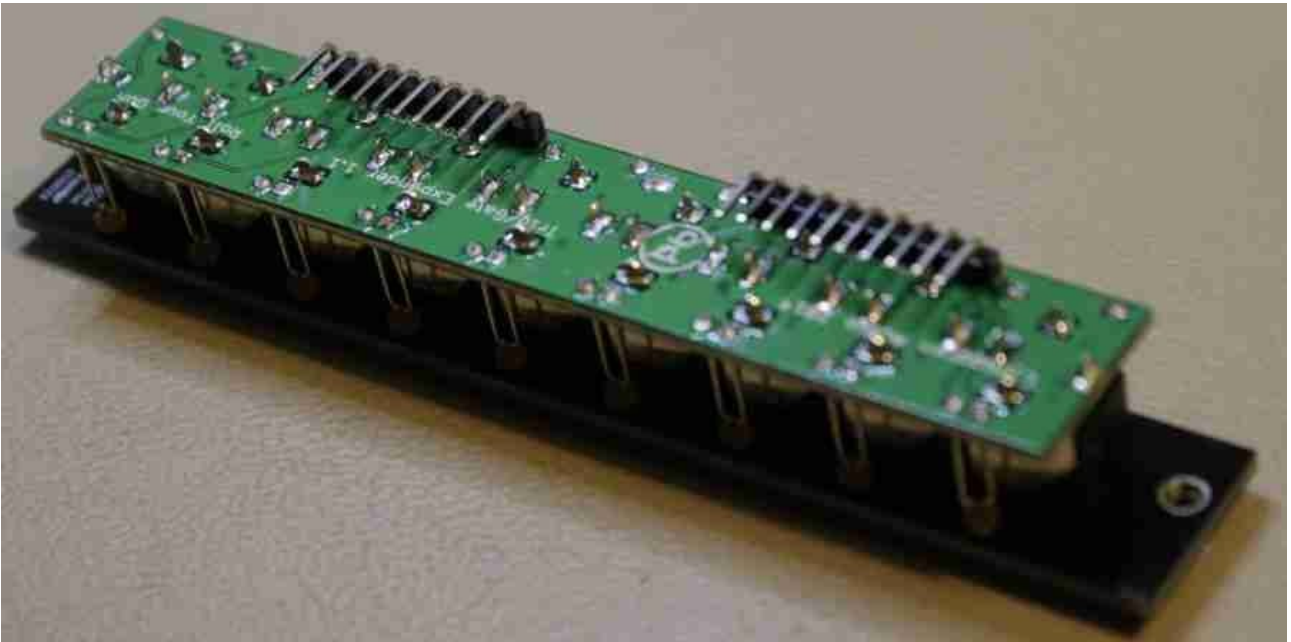

Step 19

Cut the pins off circa halfway like in the picture below.

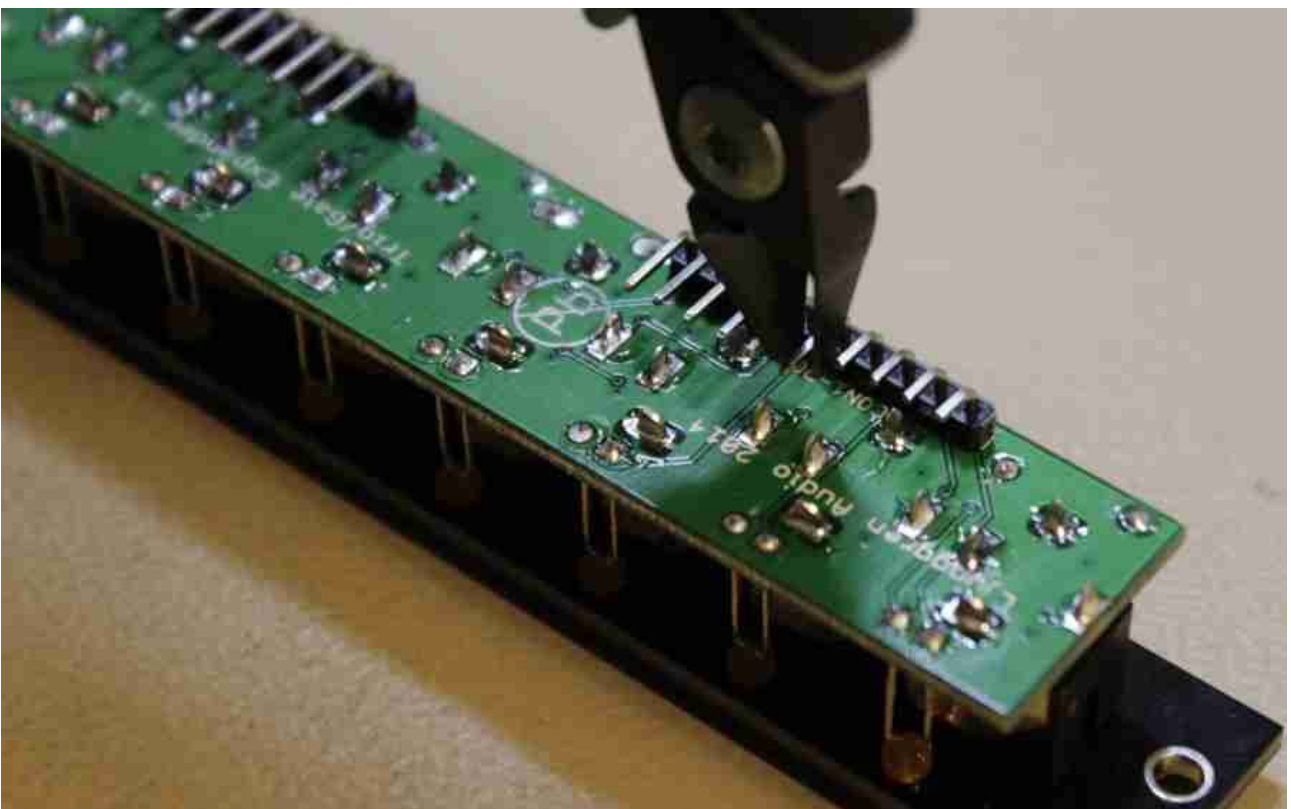

Step 20

Solder PCB2 onto the same pin strips from the bottom of the PCB like in the picture below.

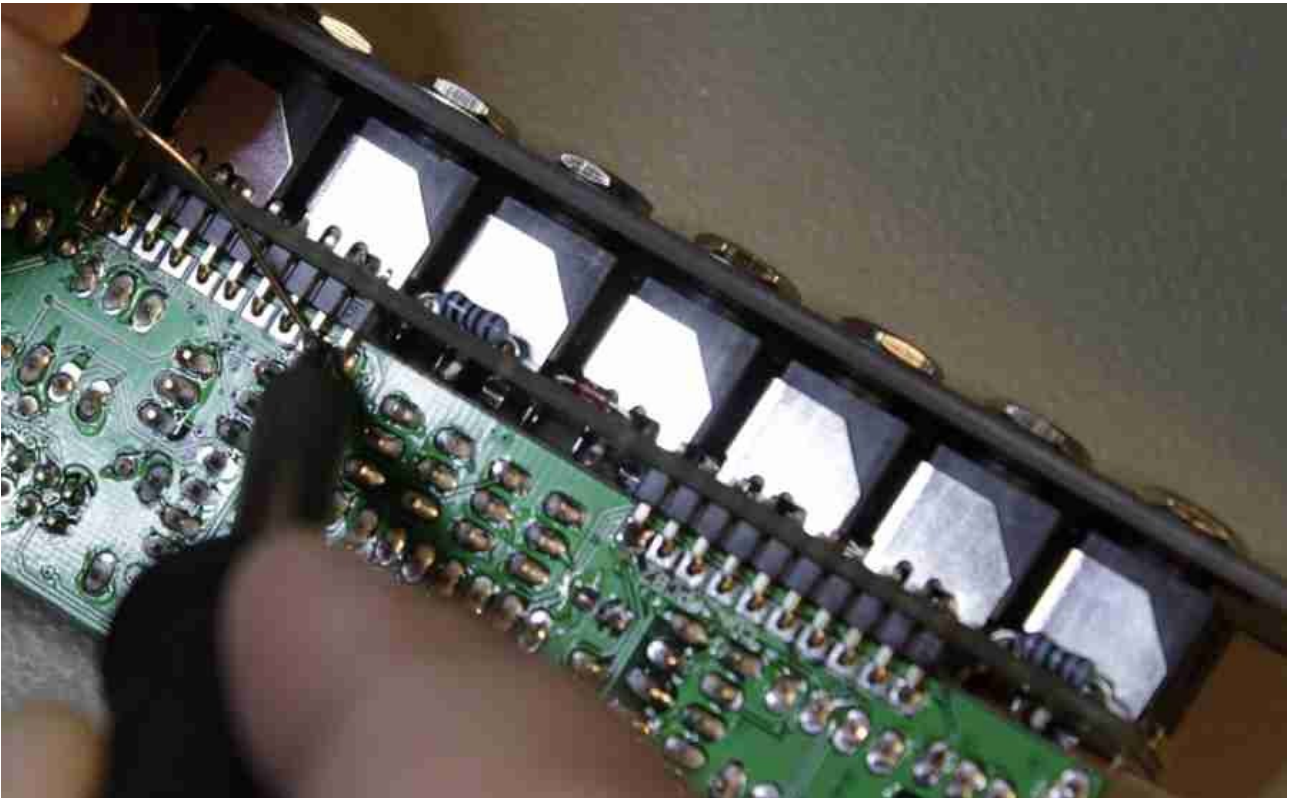

You should end up with something like this.

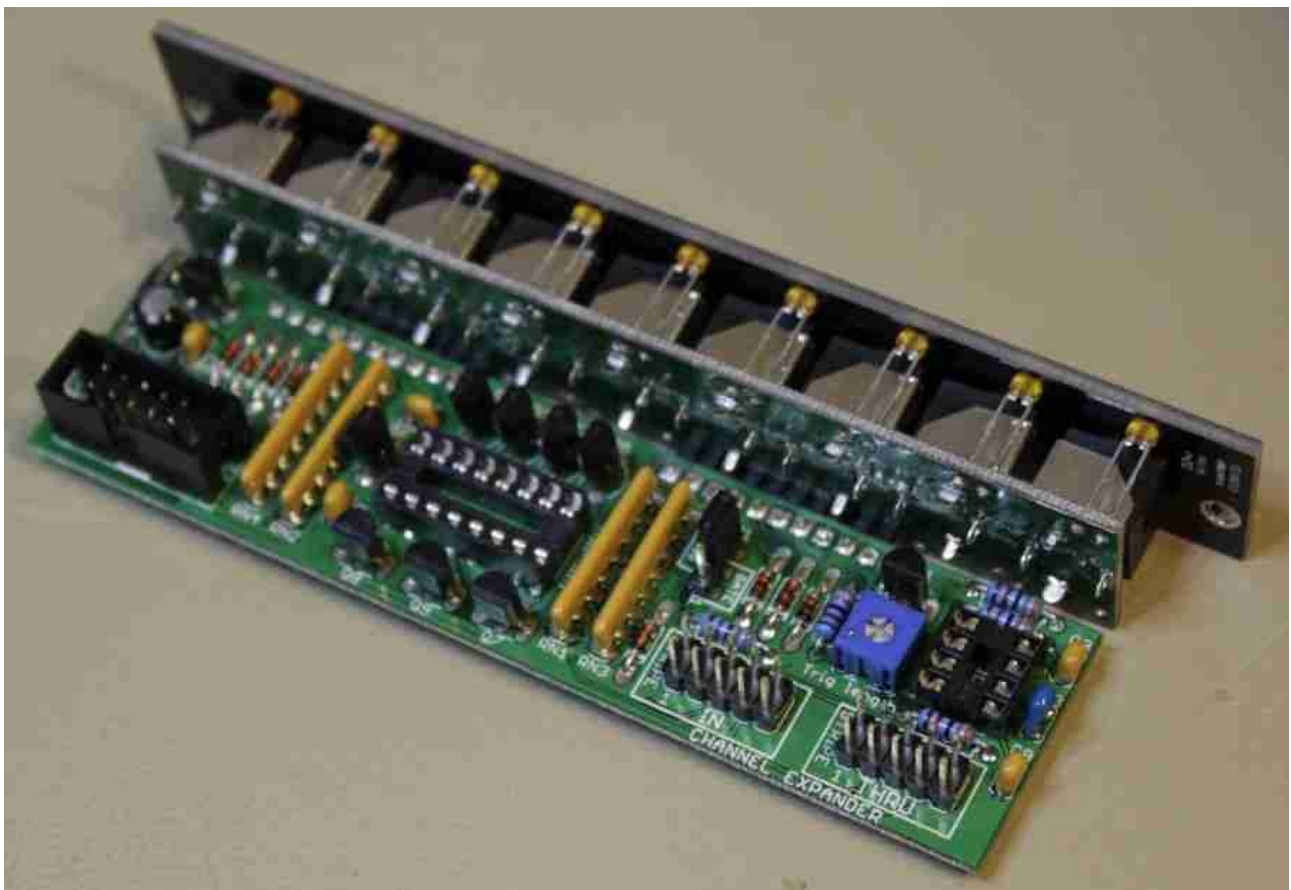

Step 21

Mount IC1: NE555 (8 pin) and IC2: CD4051 (16 pin).



Step 22

Attach the power cable (**10pin to 16pin** IDC flat cable). Make sure the stripe indicating pin 1 is on the same side as -12V.

Attach the expansion cable (**10pin to 10pin** IDC flat cable). Make sure the stripe indicating pin 1 is on the same side as the text "**STRIPE**".

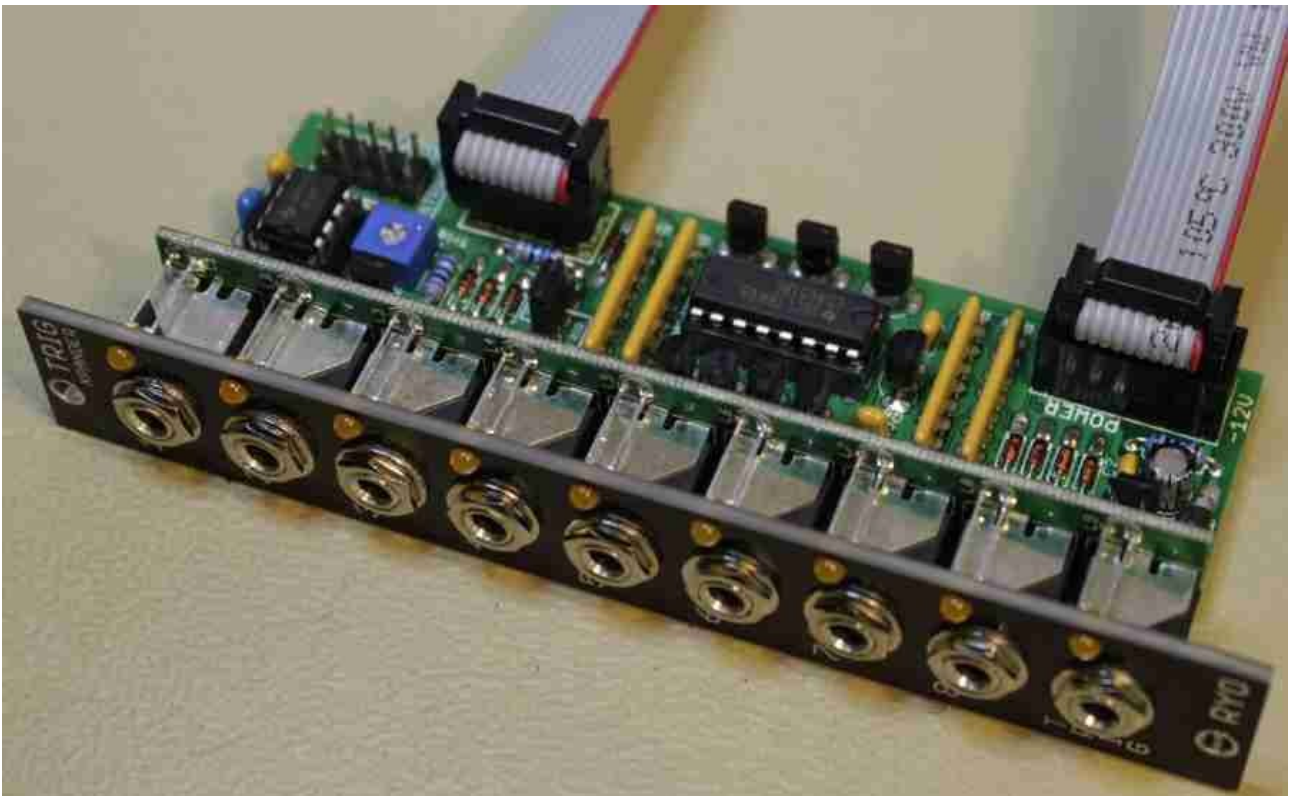

Now the module should be finished!

EXPAND-CHANNEL

