

## YOWLER BUILD DOCUMENT:

\*\*\*\*\*DISCLAMER!!!!\*\*\*\*\*

YAY! You are going to build your own Yowler noise synth, if you don't know how to solder, then you should look it up. If this is your first time building anything electronic be aware that you might make a mistake, it is possible to not build the Yowler correctly or even break it. These instructions are as clear as I can make them, but mistakes do happen.

I **cant** offer you a replacement if you make a mistake building the Yowler, sorry. If you do make a mistake, you are welcome to contact me with a full high res photograph of both the front and back of your board. And I can try to take a look at it. If I don't get back to I'm most likely swamped with other work, ill try though, if I don't get back to you after a few days, try again.

[catfulofghosts@gmail.com](mailto:catfulofghosts@gmail.com)

\*\*\*\*\*

### Tools you need:



Side cutters for cutting the leads, flat head screwdriver for attaching the knobs, Philips head screwdriver for the m3 bolts and a 9v battery for testing.



Oh and a soldering iron and solder (thinner solder is easier to use)

**Stuff that will be helpful but not 100% necessary:**



electrical tape to hold in the dc jack as you solder it and adhesive to attach the 9v battery clasp. (I use The Selleys Kwik Grip Crystal Clear , but any thick adhesive should work like liquid nails, or use double sided tape if you want something ½ way between rock solid and loose.)



**START THE BUILD:** (the method I use is the quickest way to build the Yowler, I'm sure there are more logical ways, but I'm building 50 of them so I'm going to use this method.)

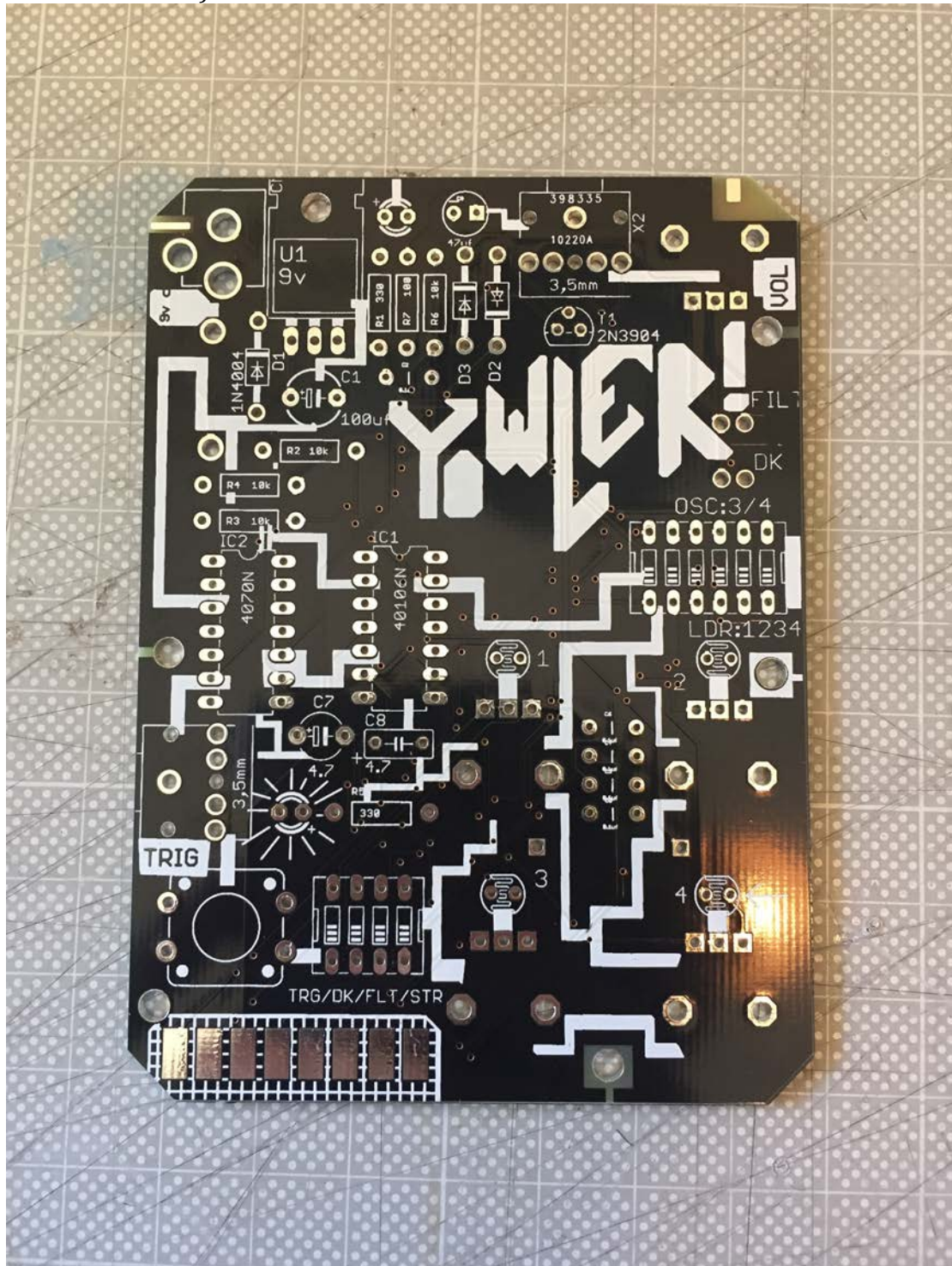

**Attach the tact button:**





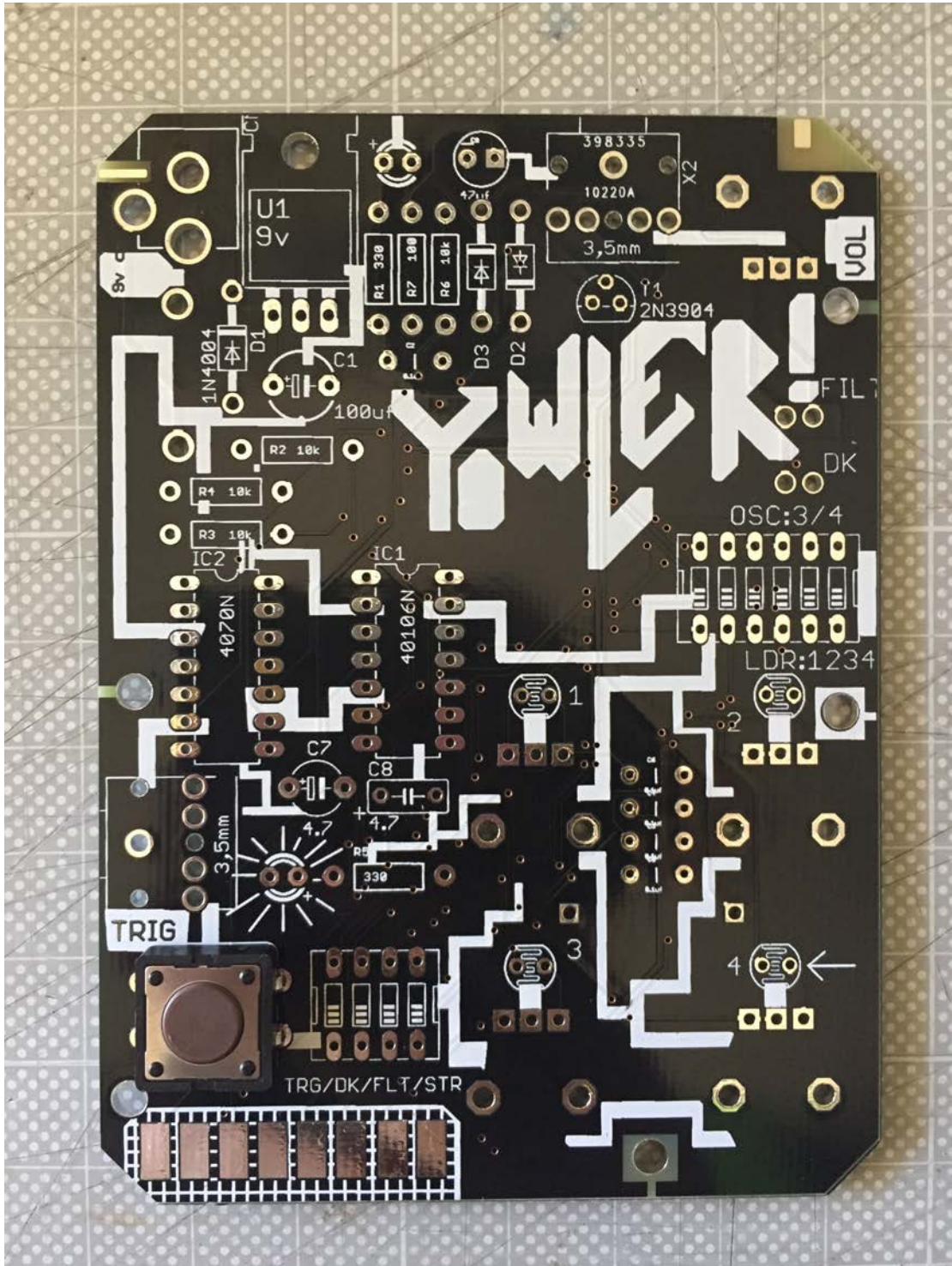

don't solder yet, we are going to populate the board with a bunch of components with short leads first.

**Attach the DIP switches and the DIL sockets:**

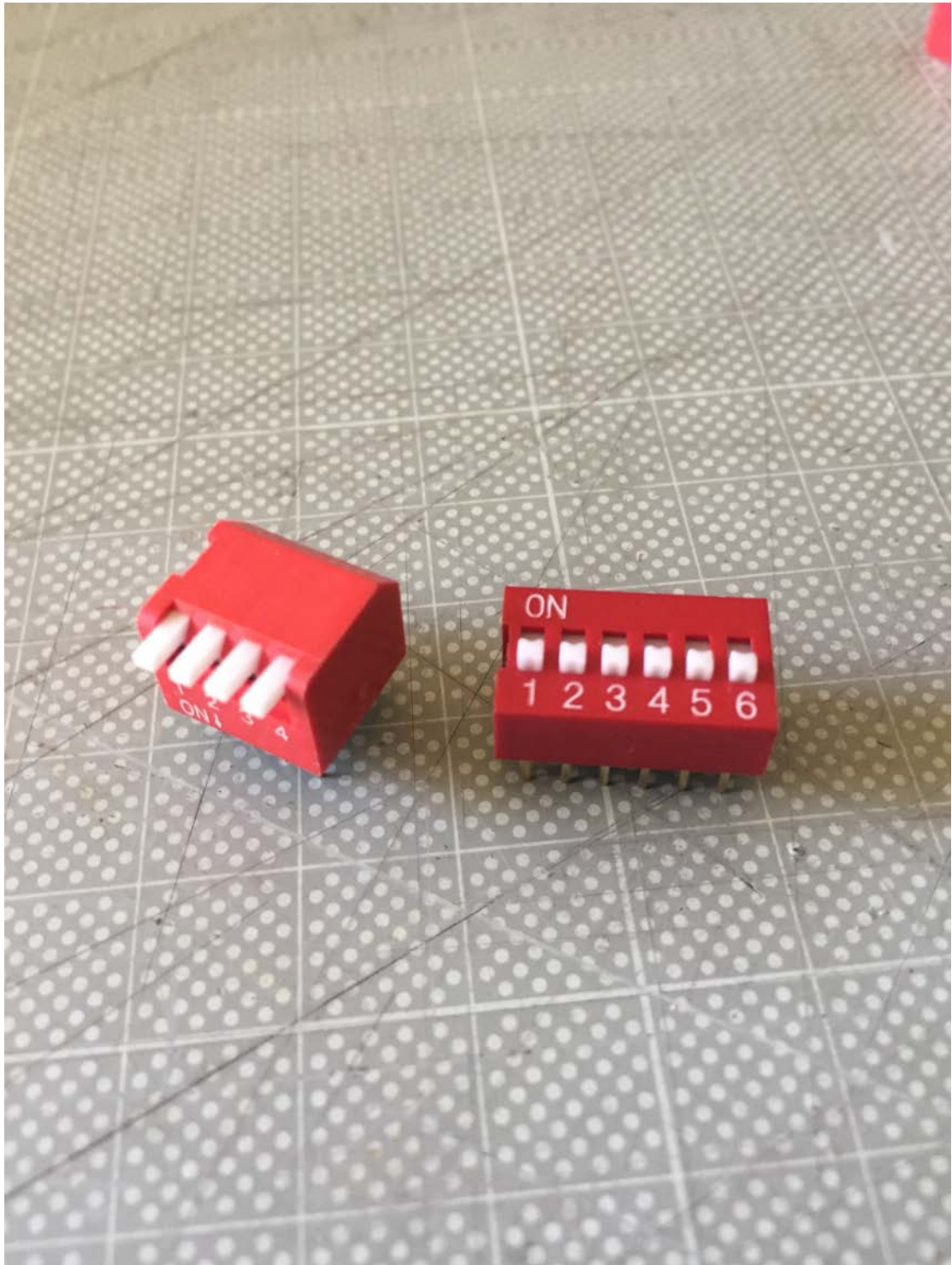





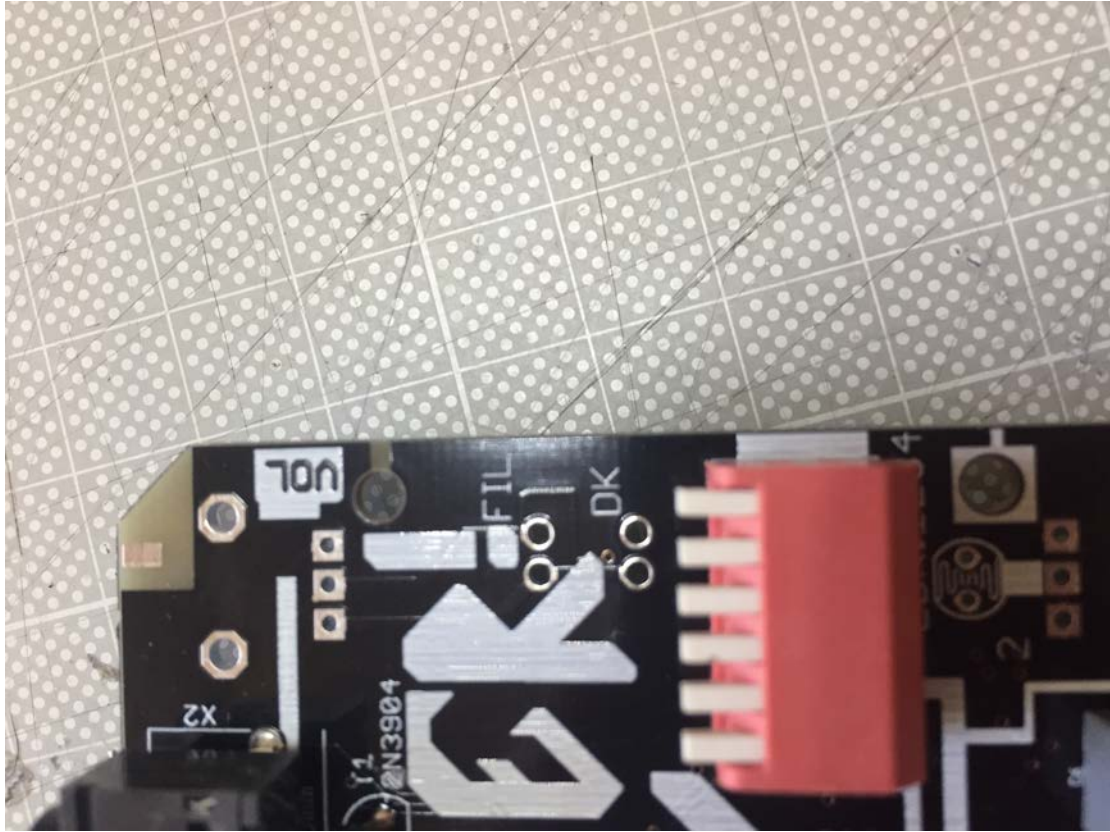

\* If you have piano style DIP switch (pictured below) mount with teeth facing the DK text.



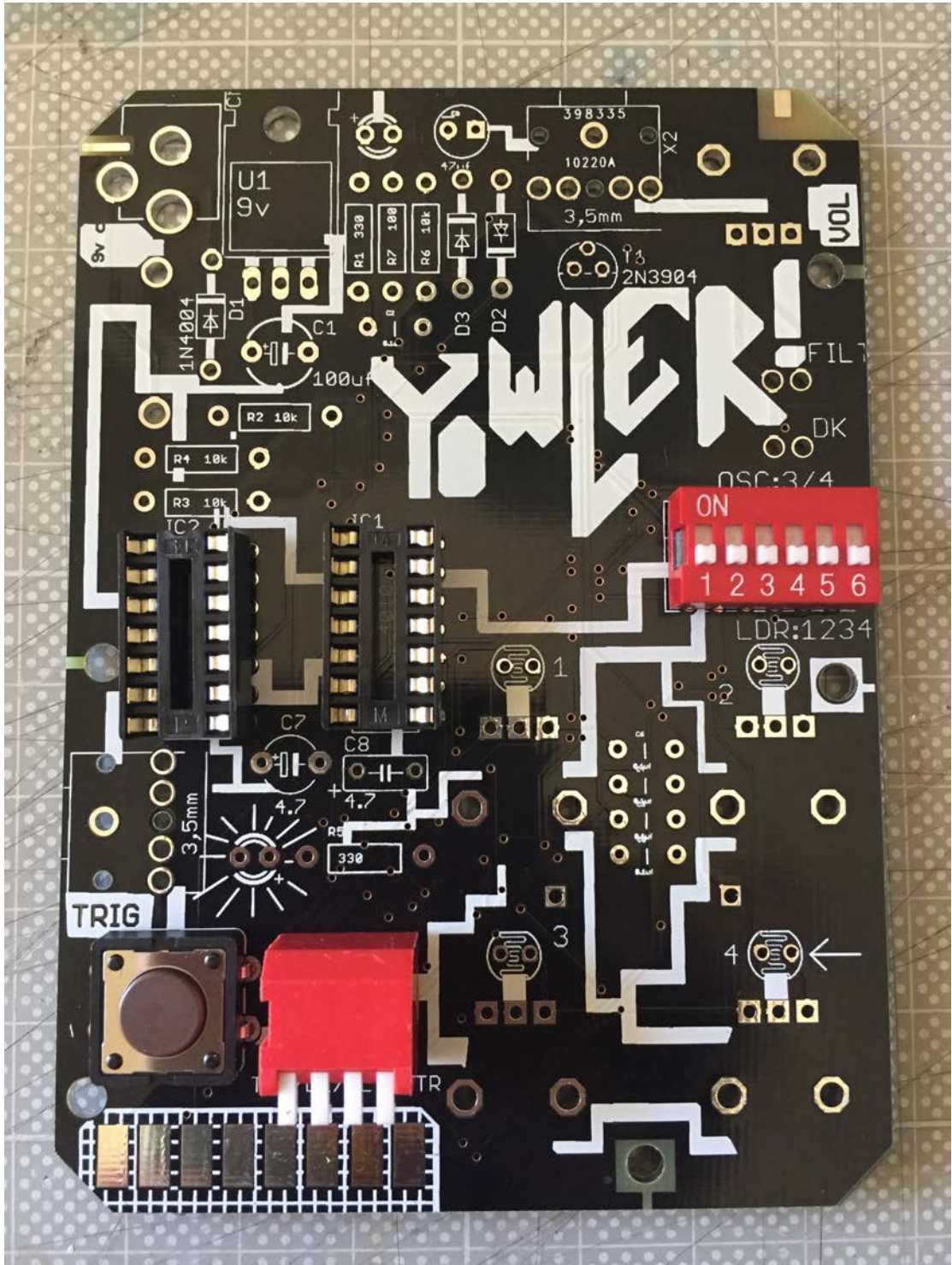

Make sure the bump on the DIL is facing UPWARDS

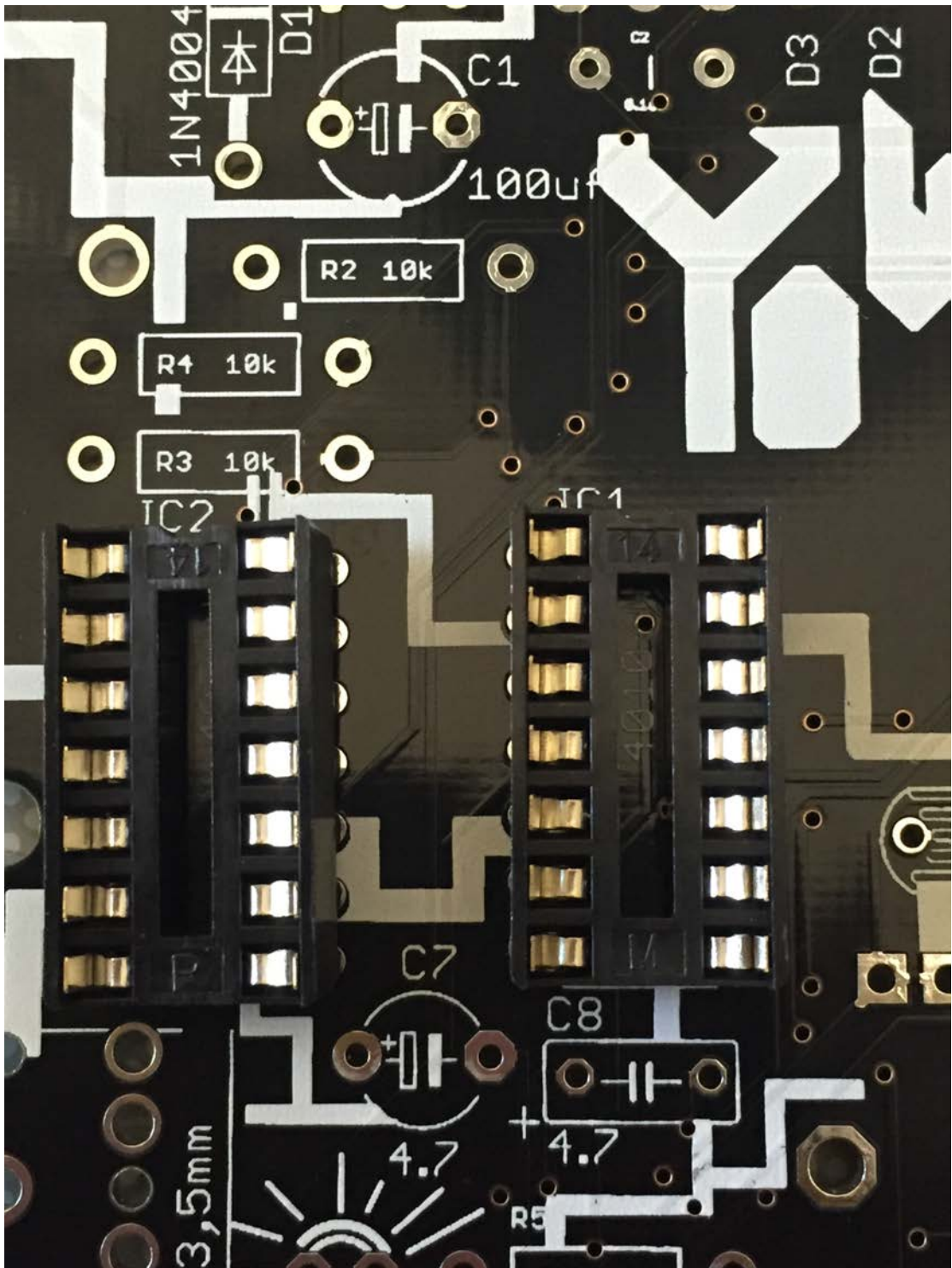

**Attach the Stereo Jacks:**



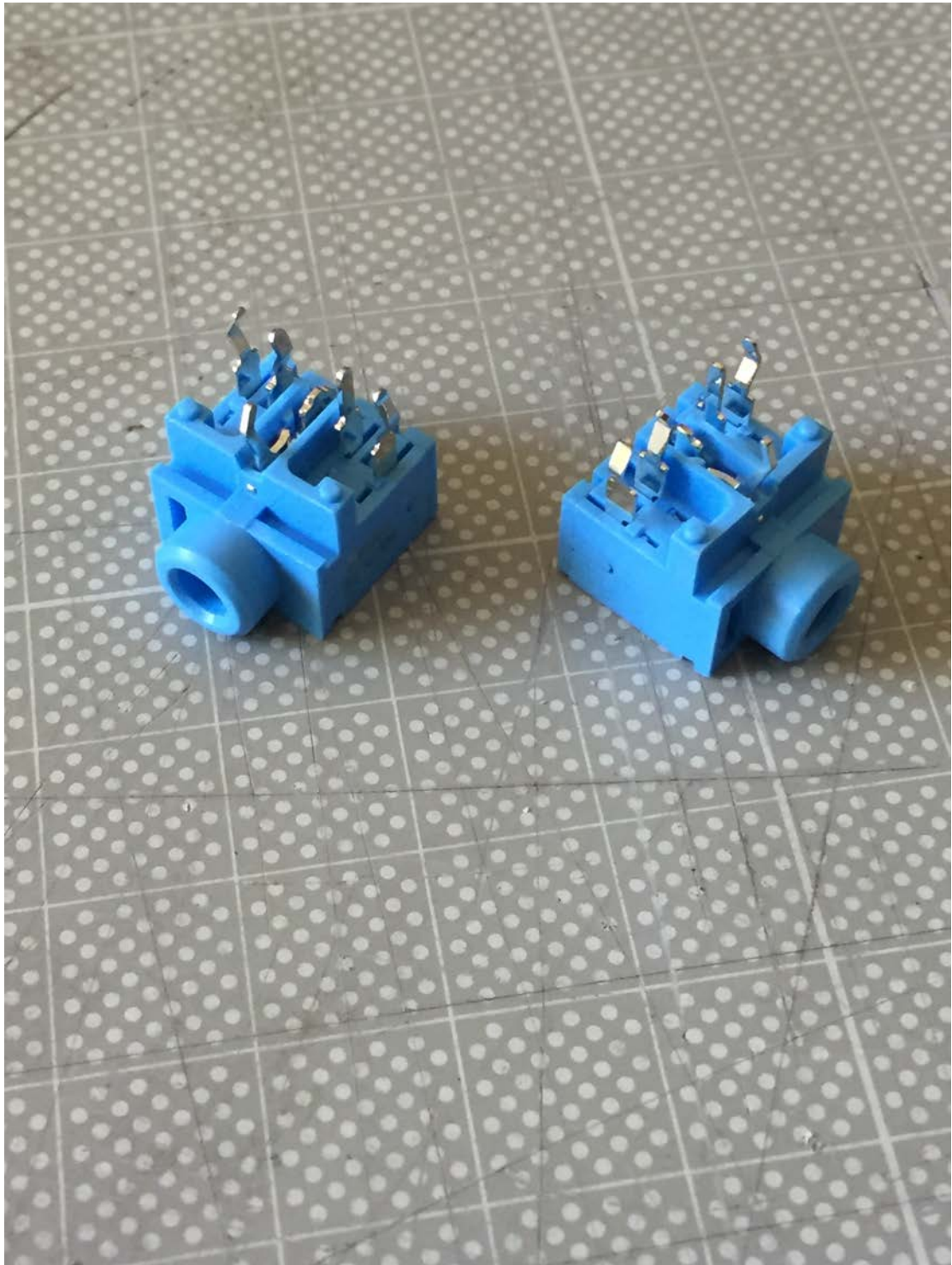

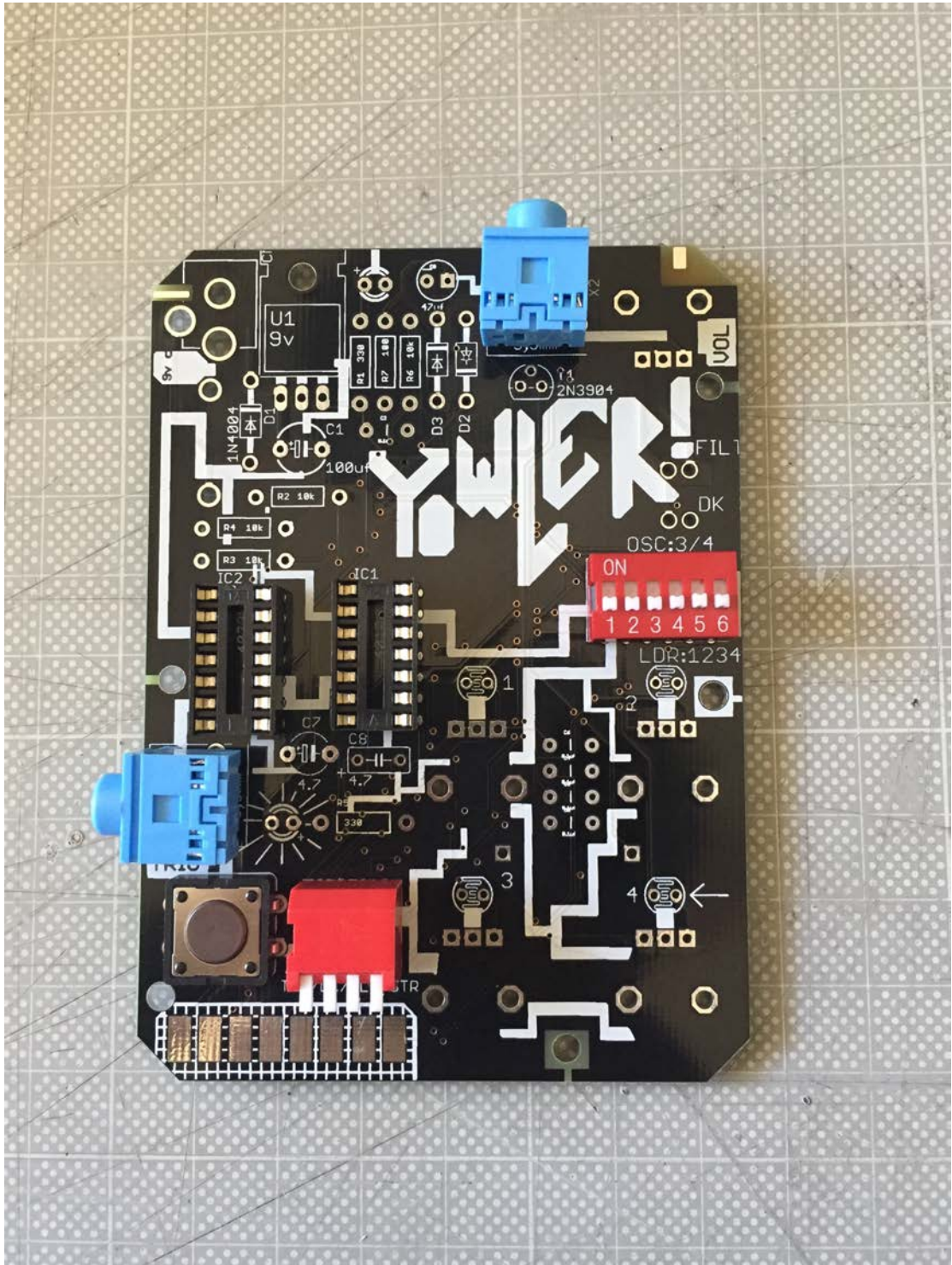

**Attach the 9v power regulator:**





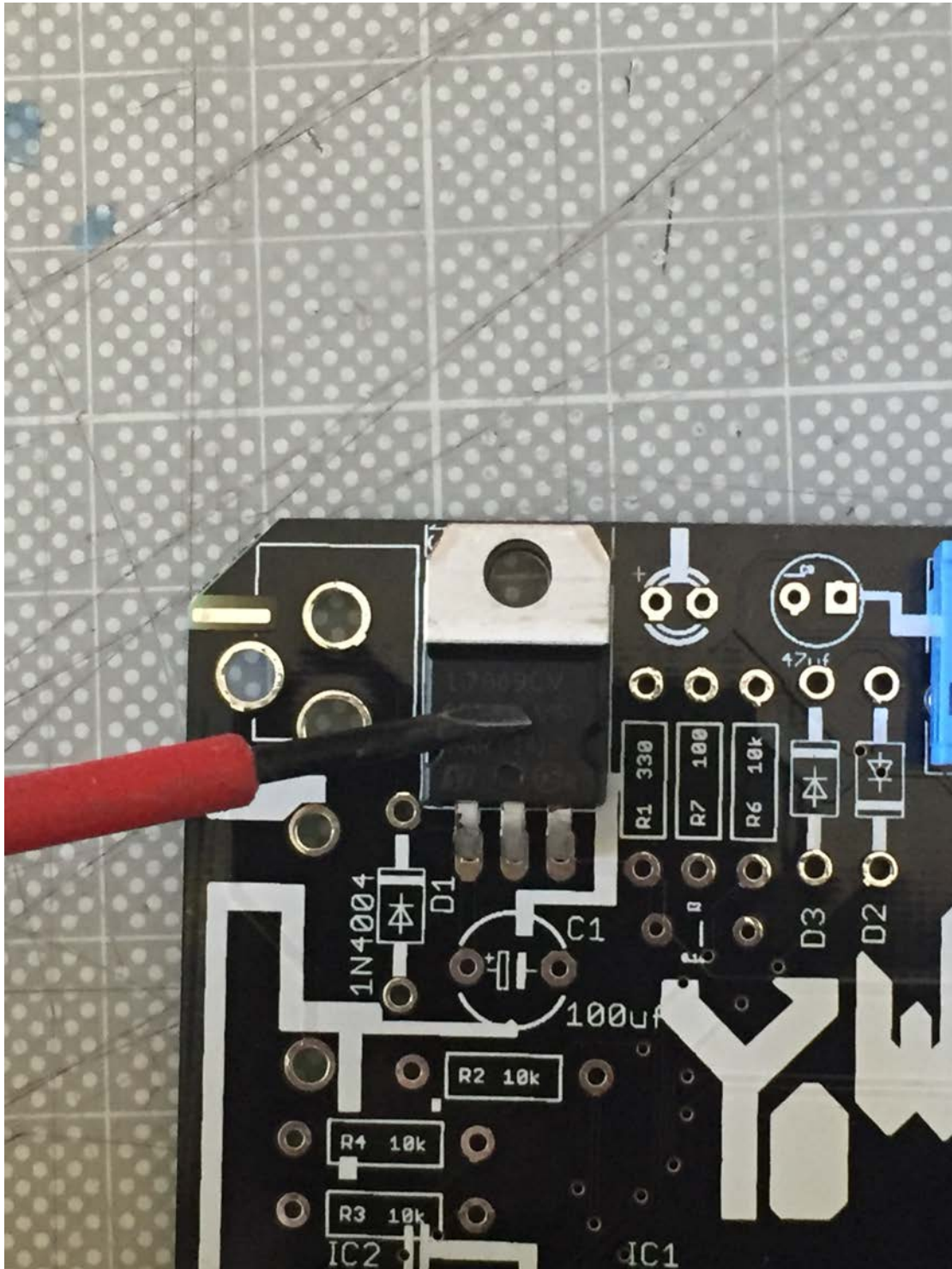

**Attach the 1n4004 Diode, 0.1uf cap and the 100uf cap:**



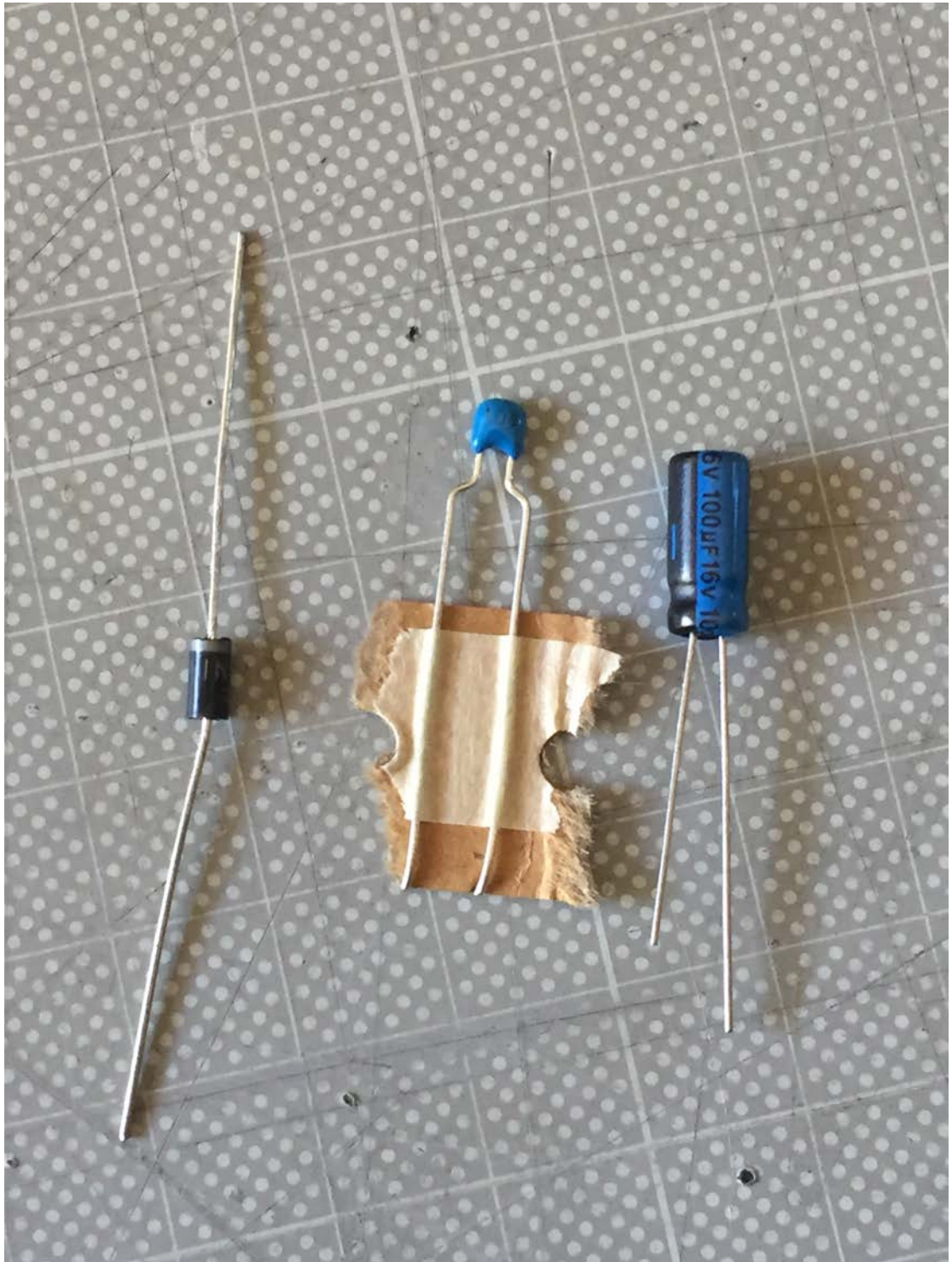

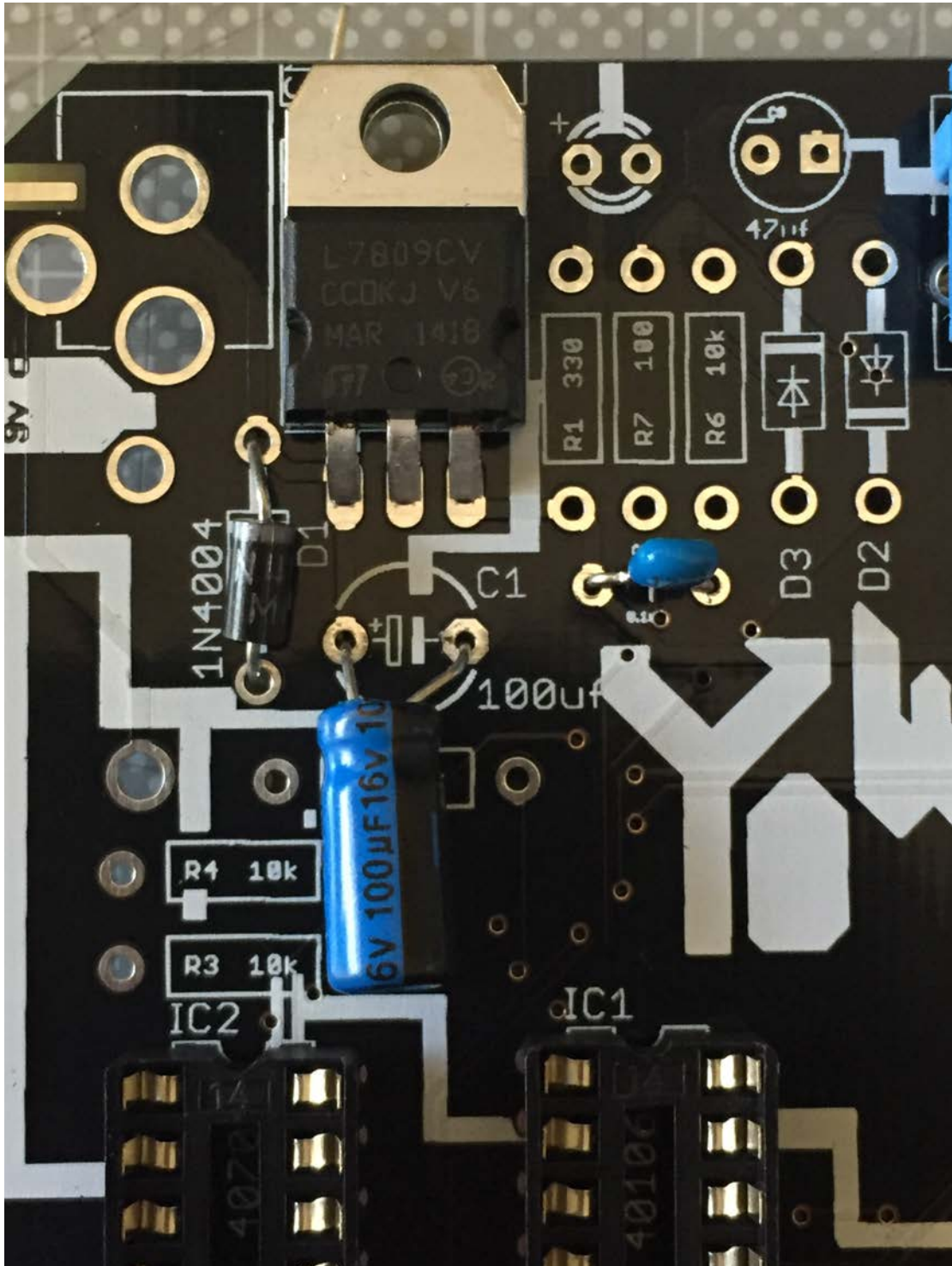

Check which way the diode and 100uf cap have to go. (you will see that the 100uf cap is lying down, if you are adding the acrylic top plate you will need to lie this component down before you solder, so it fits under the top plate.

**Attach the other 0.1uf caps:**





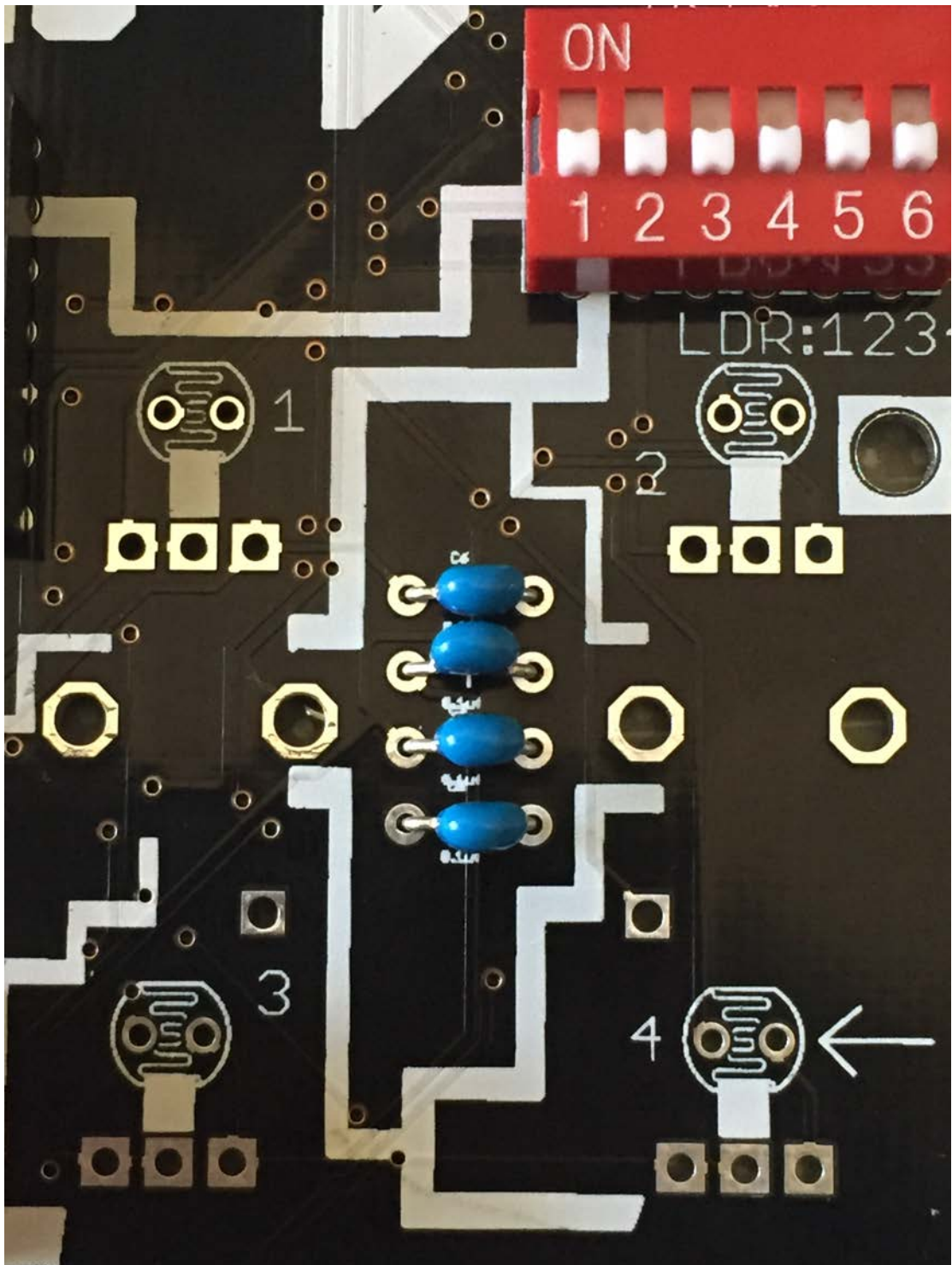

**Attach the Transistor:**



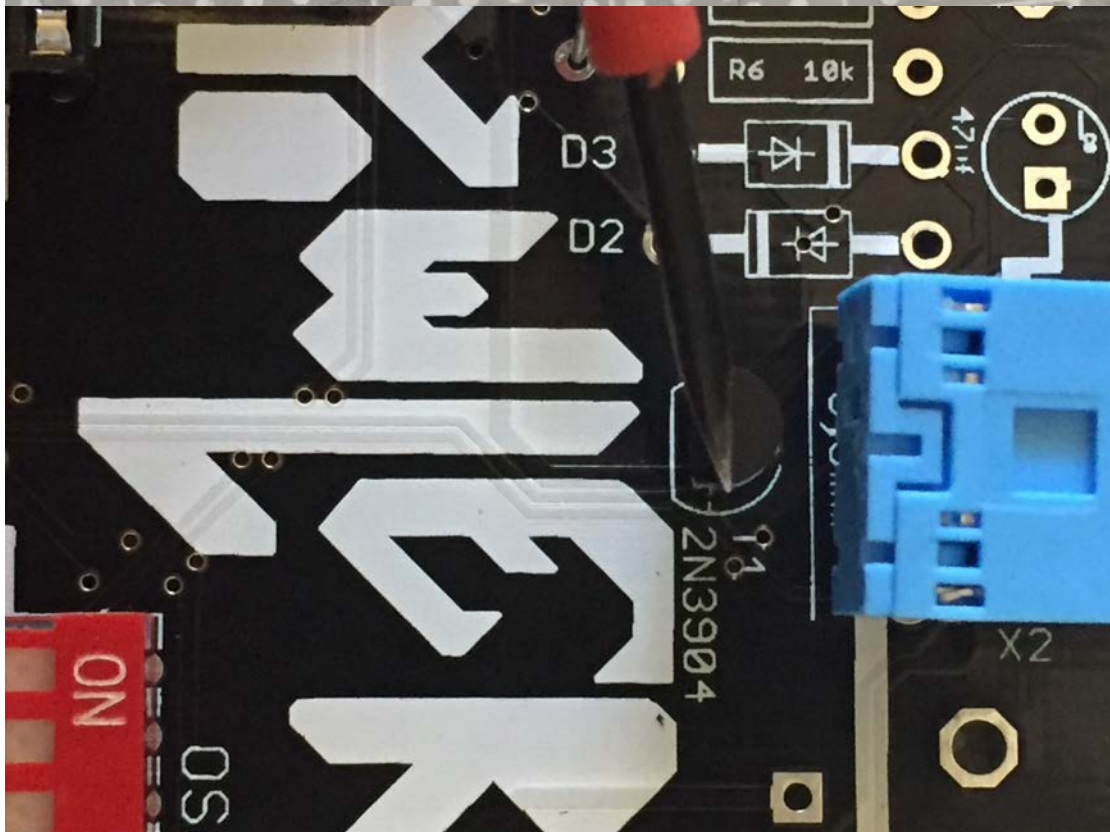

NOW IS A GOOD TIME TO SOLDER ALL THESE COMPONENTS ON AND CLIP ANY LONG LEADS, Try to make sure all the components sit as flush with the board as they can.

**Add the LDRs:**





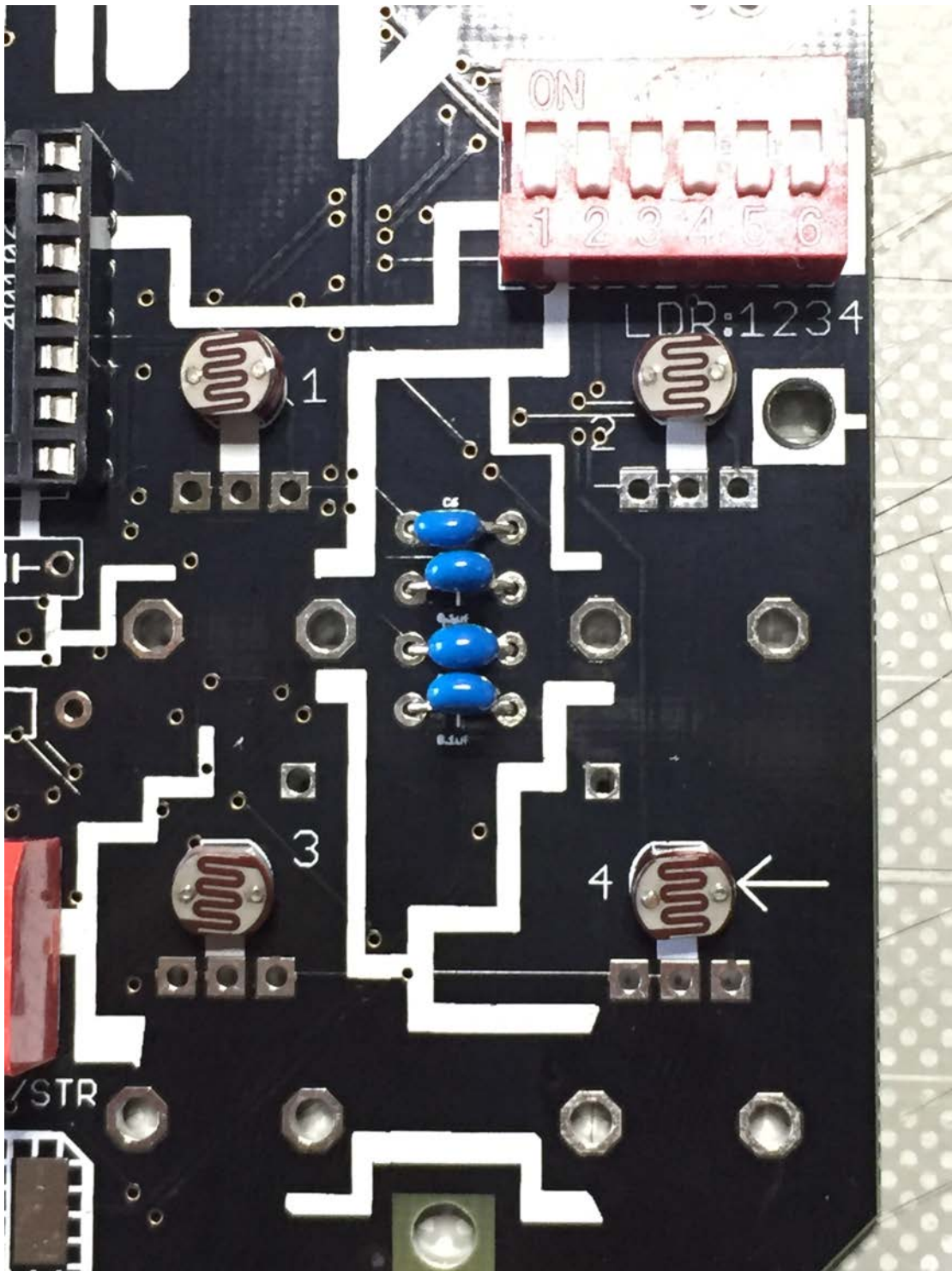

**Add DC JACK:** (you may need to use electrical tape to hold it in place while you solder.





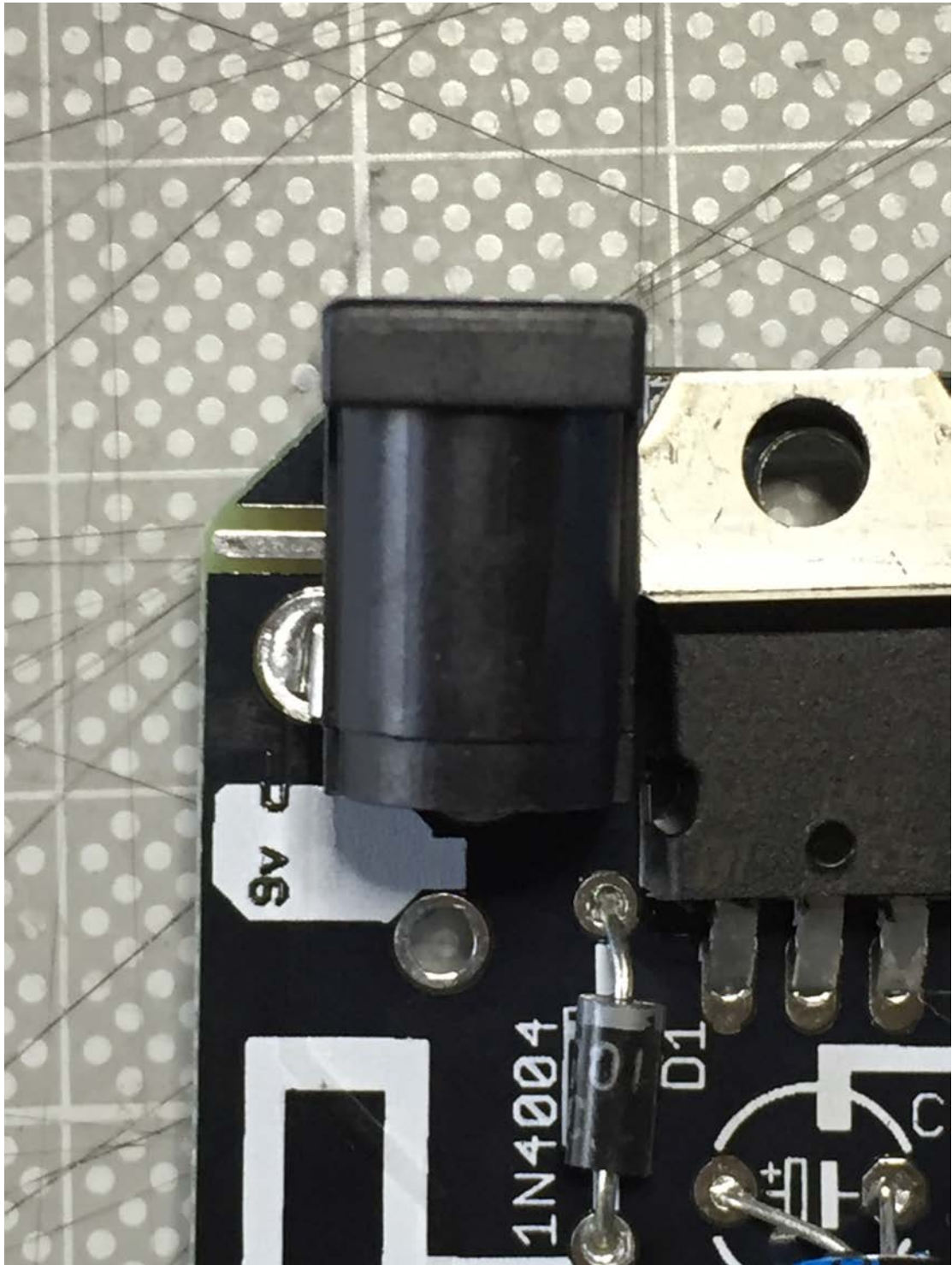

**Add the 47uf cap:**

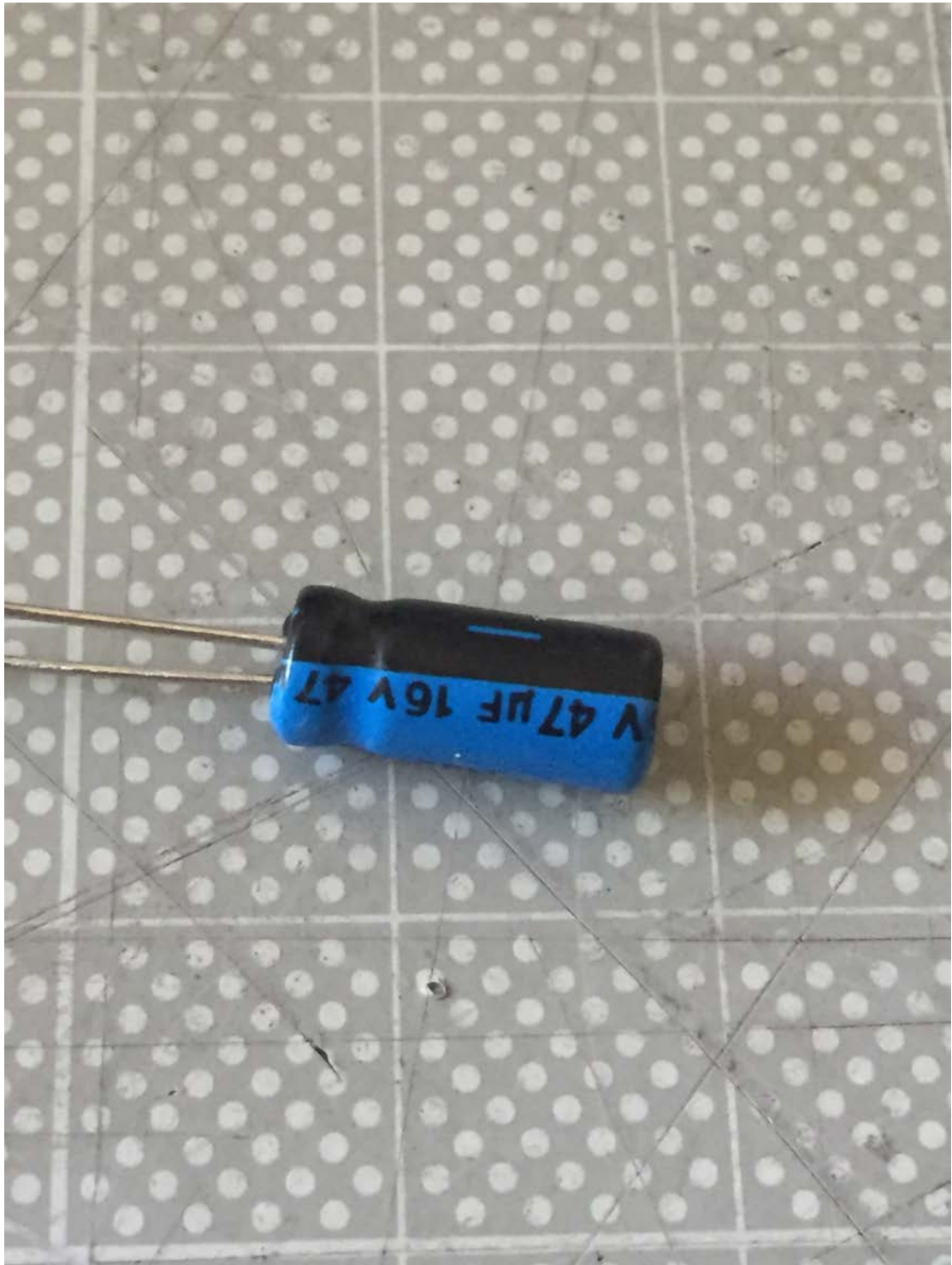



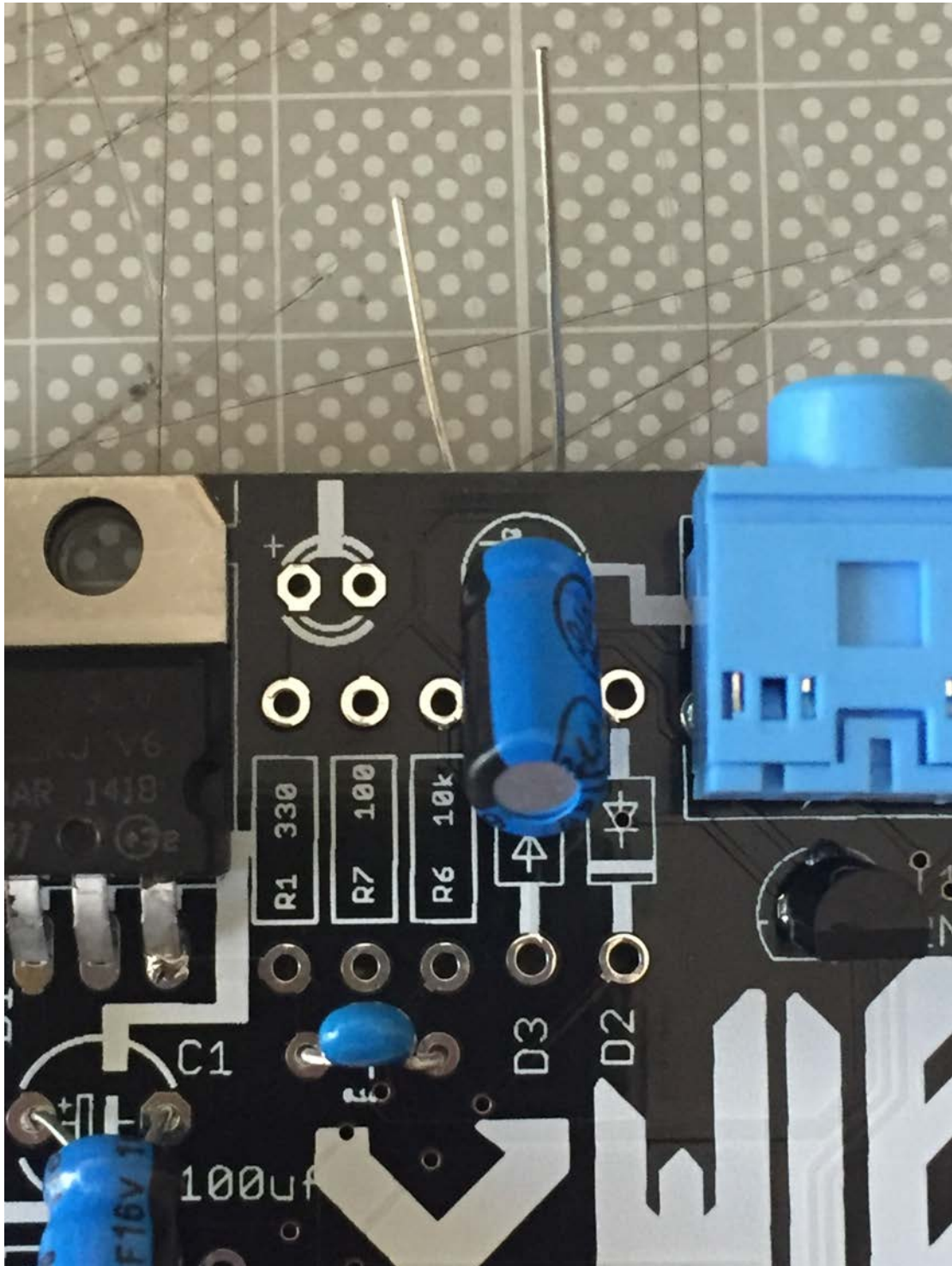

(again this one is lying down to fit under the acrylic top plate)+(make sure it is facing in the right direction)

**Add the VCA DIODES:**

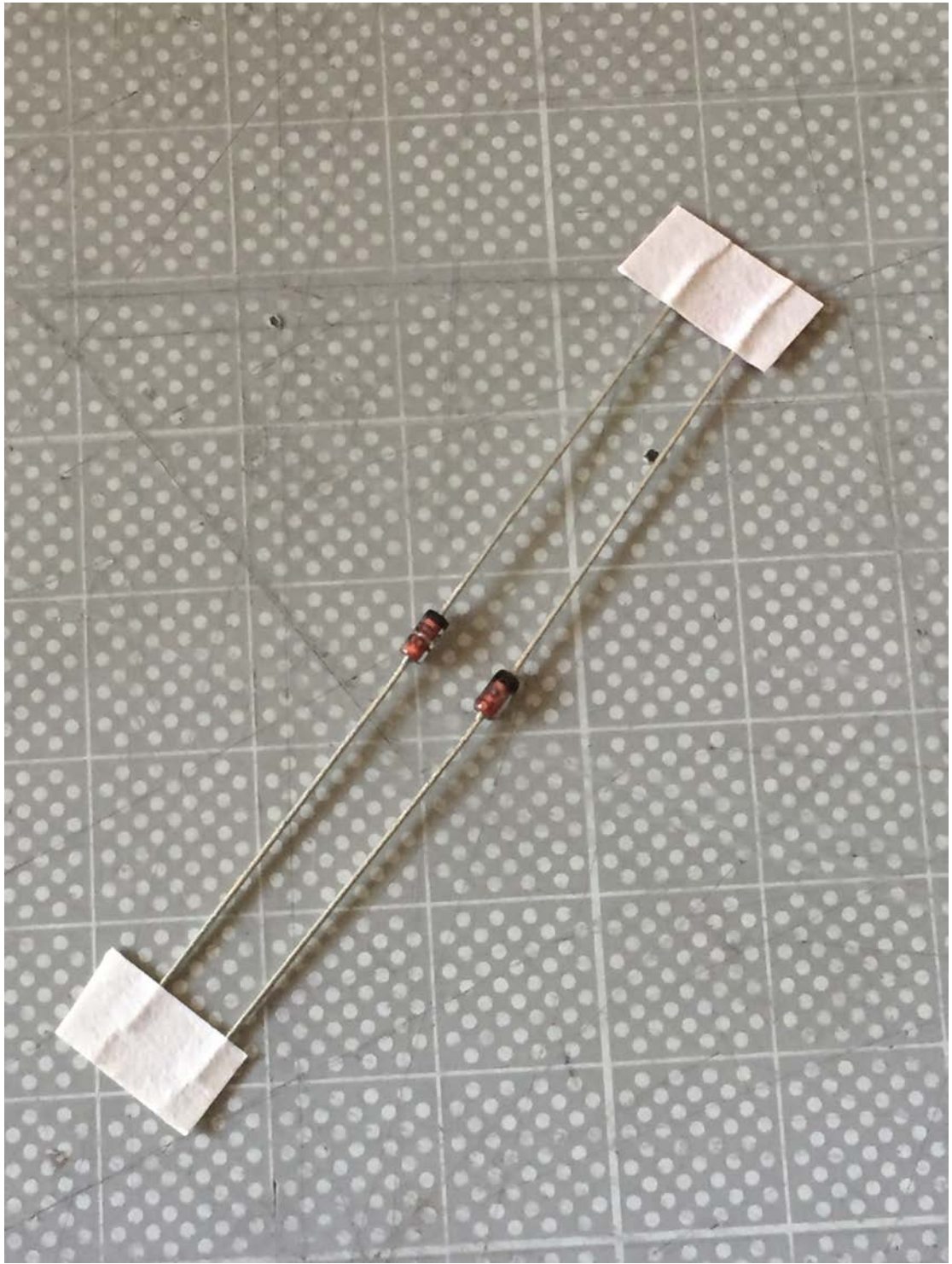



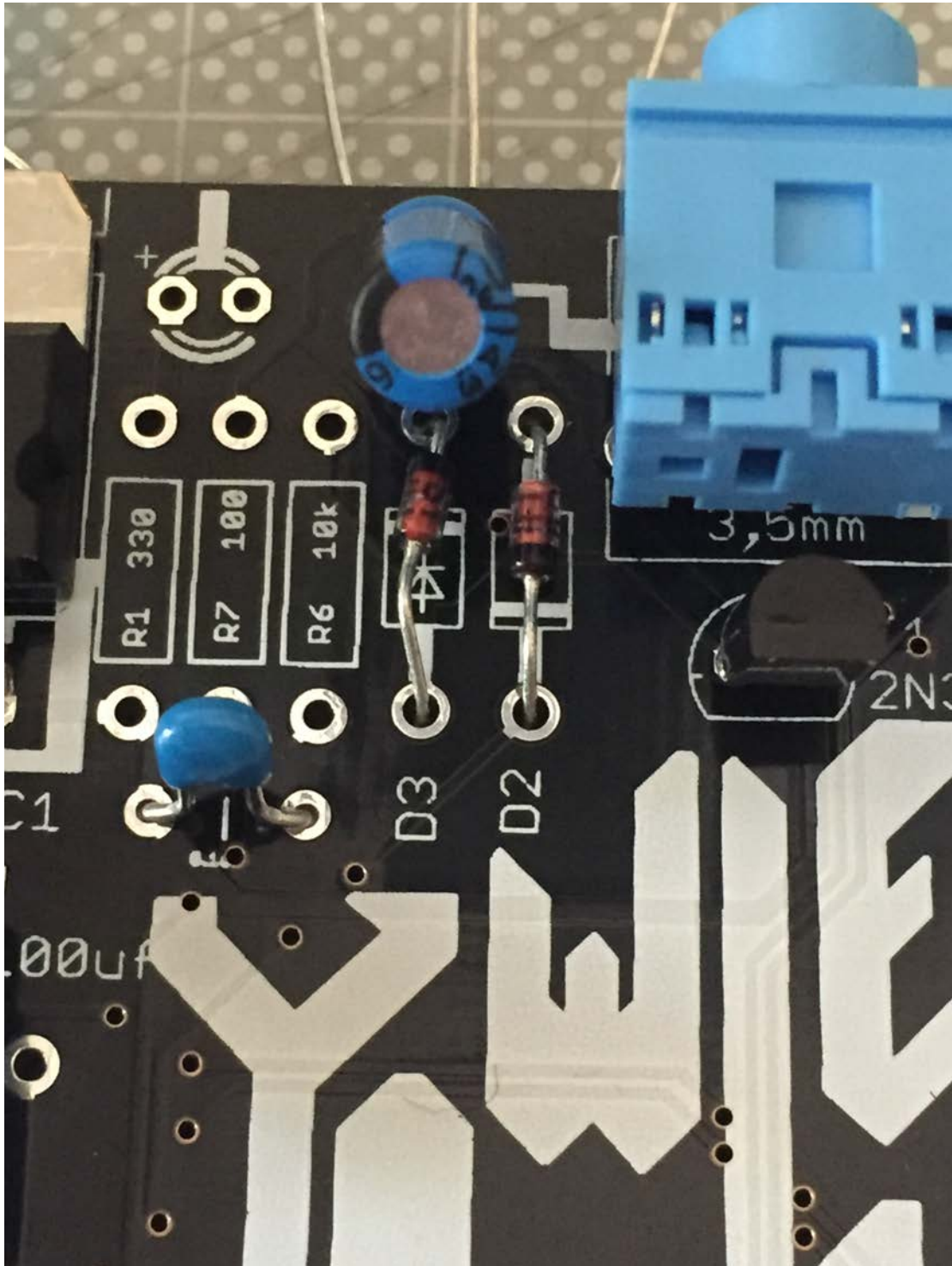

(as with the last diode, be sure the lines on the diode are facing in the direction of the symbols on the circuit board)

**Add the LEDs:**





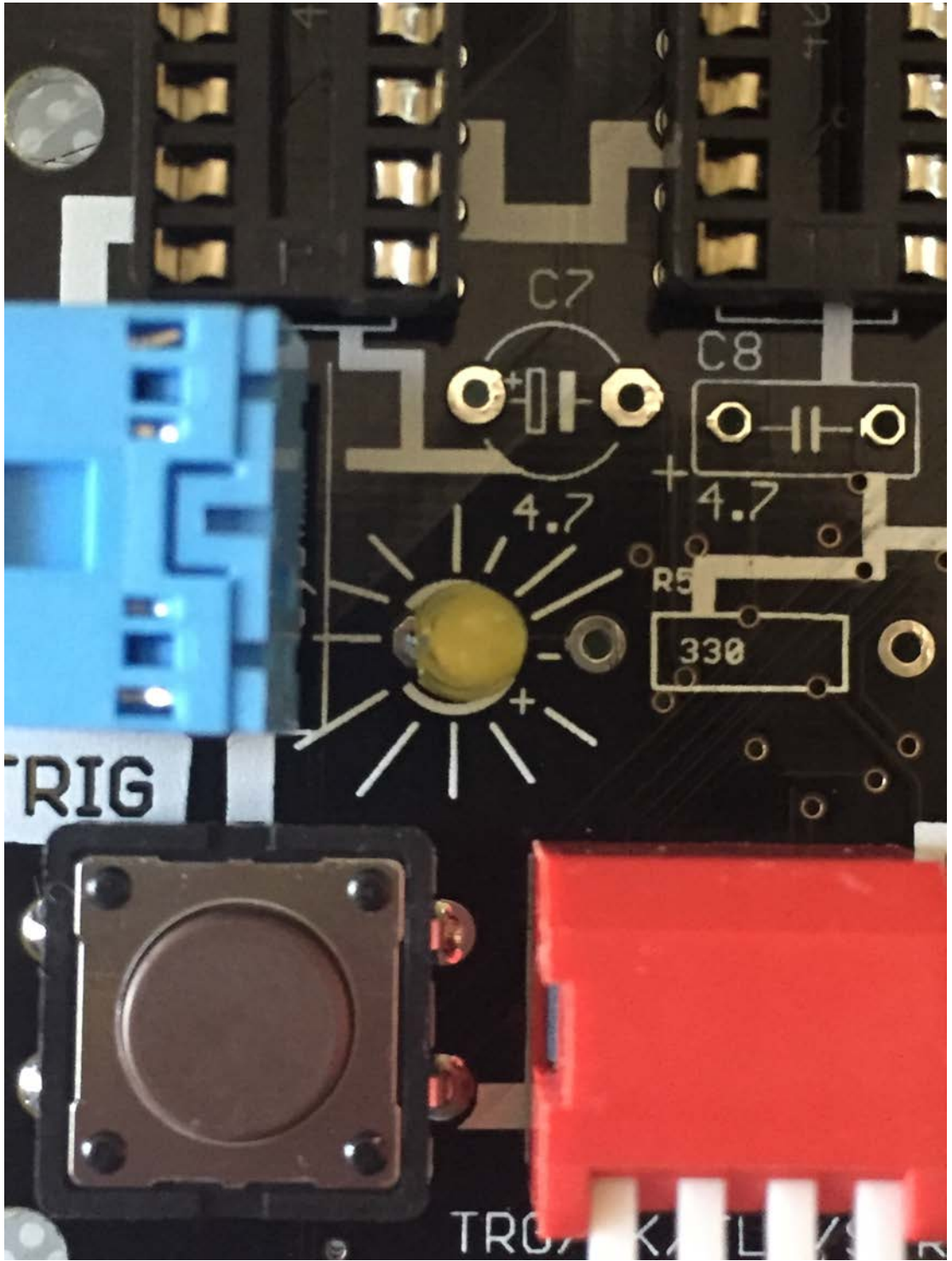

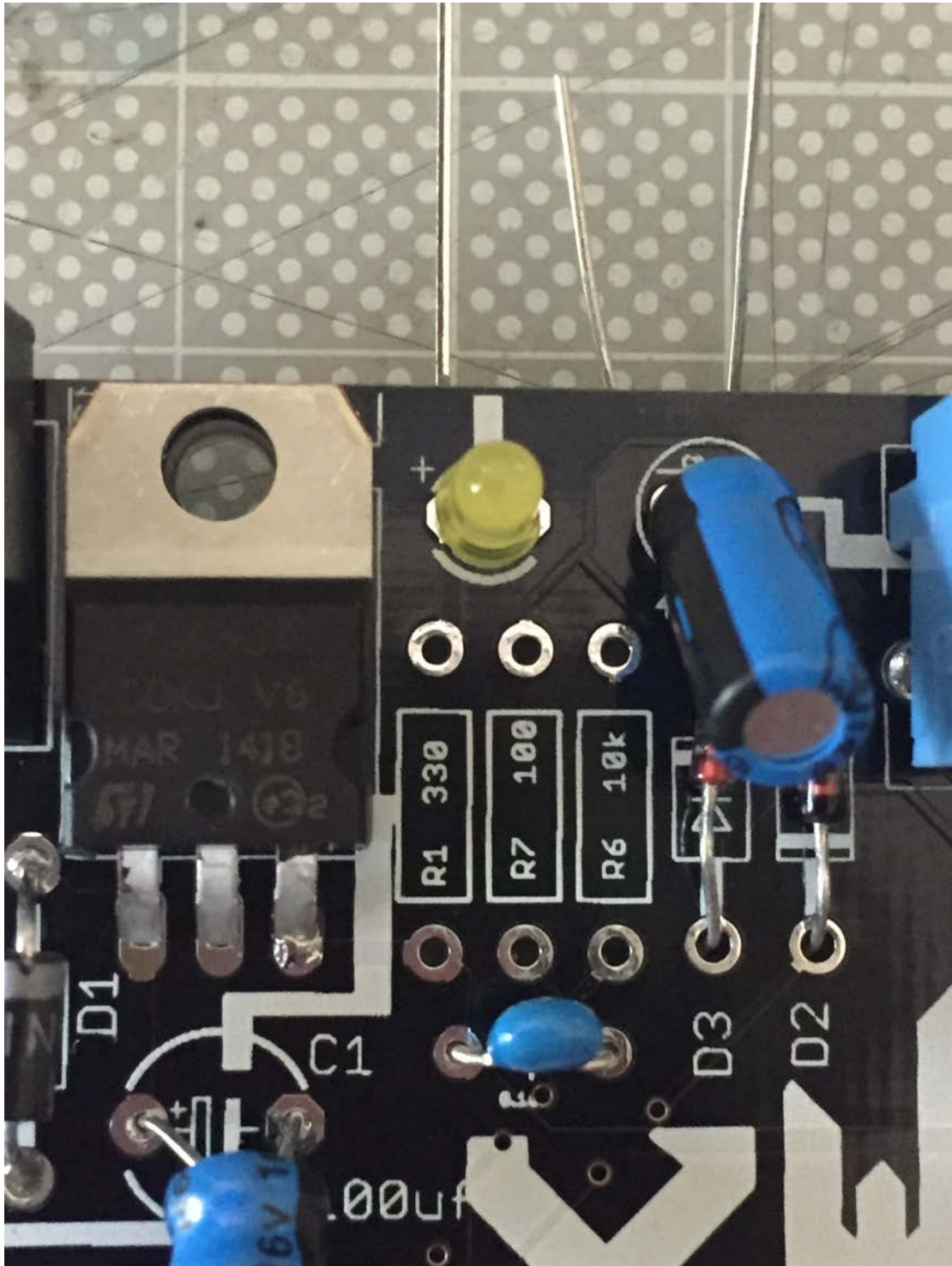

(There is one long and one short leg, the long leg must face the + on the circuit board)

**Add the POTS:**







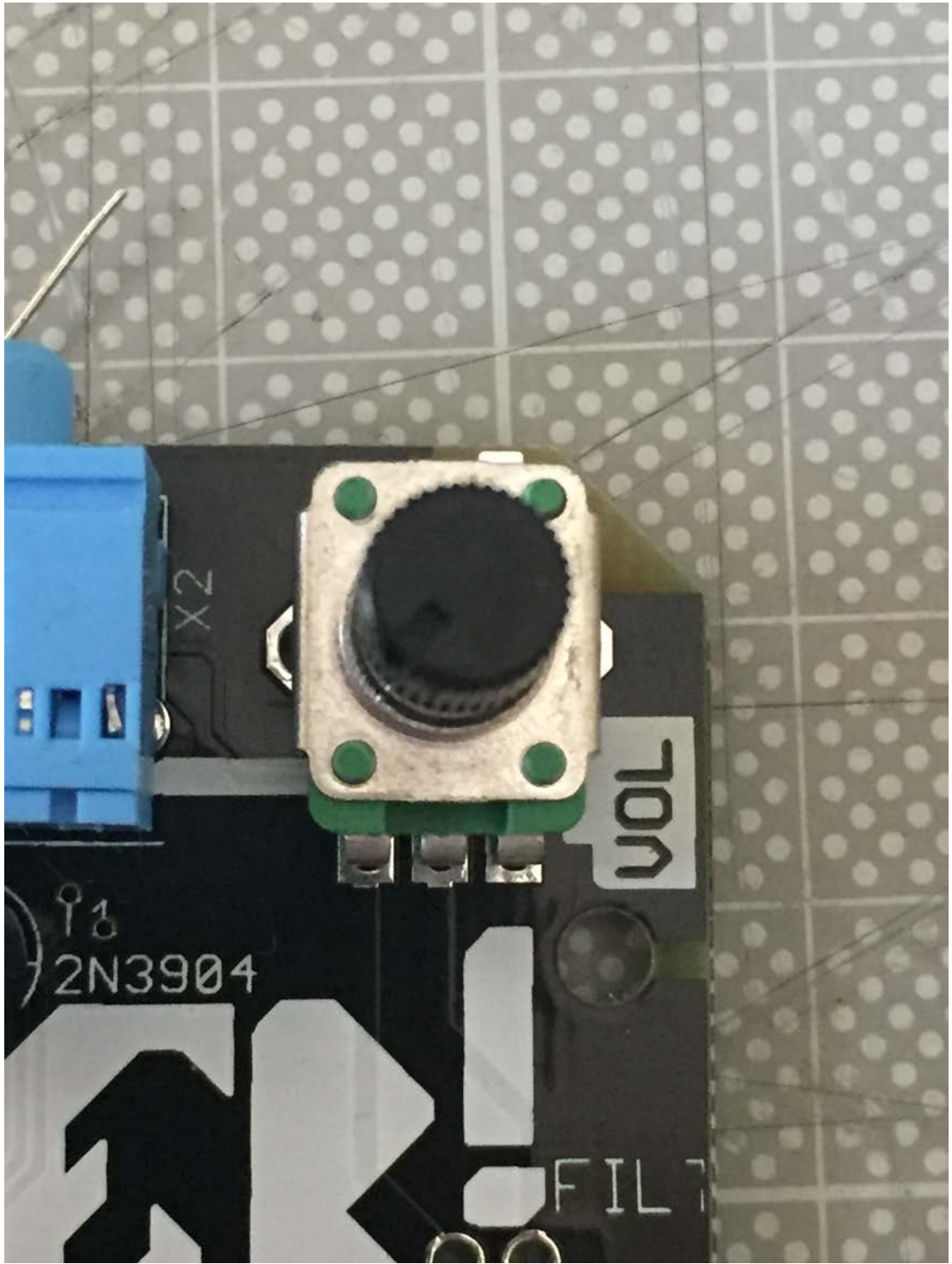

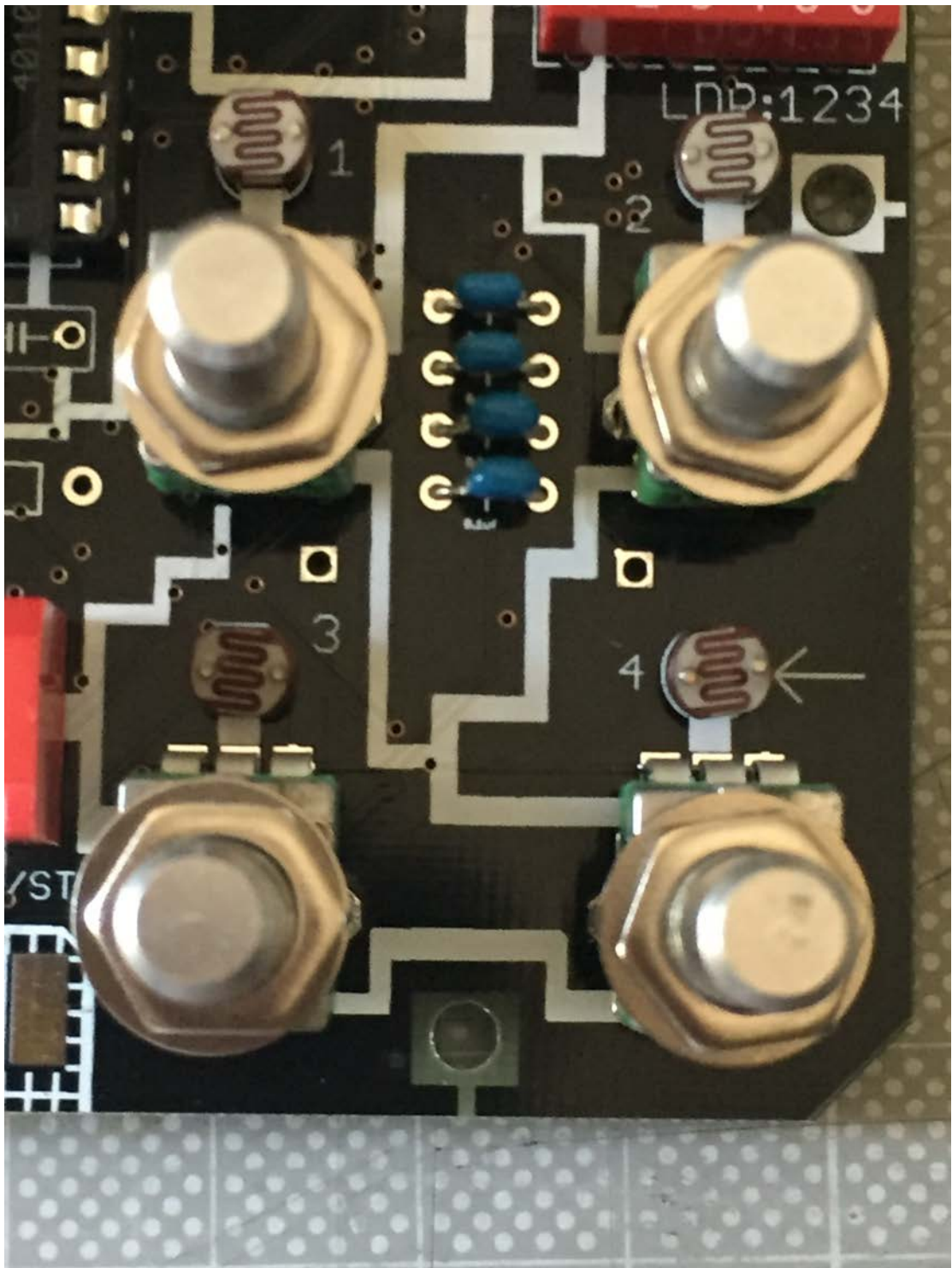

**Add the 100ohm resistor:**





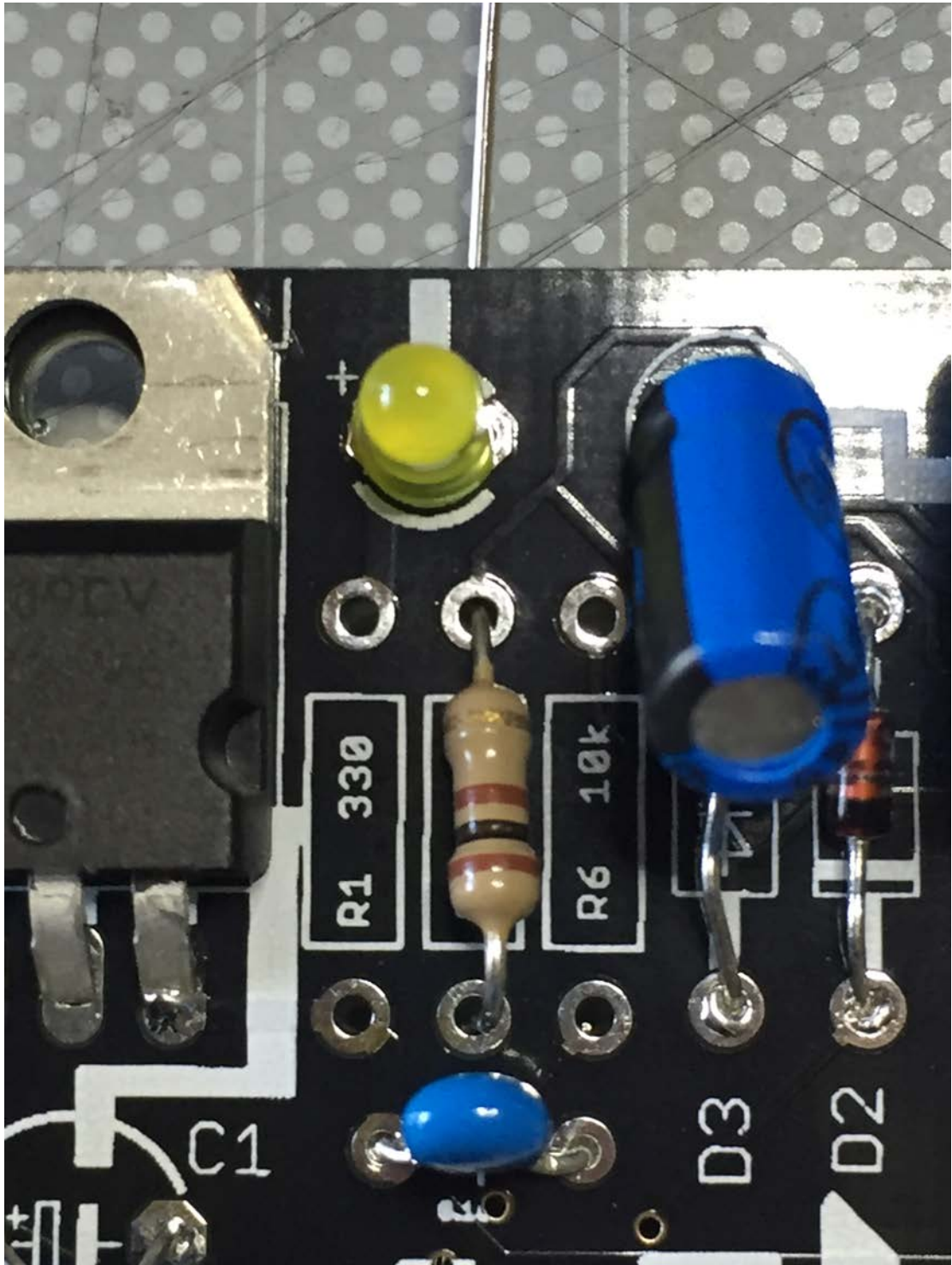

**Add the 10k ohm resistors:**

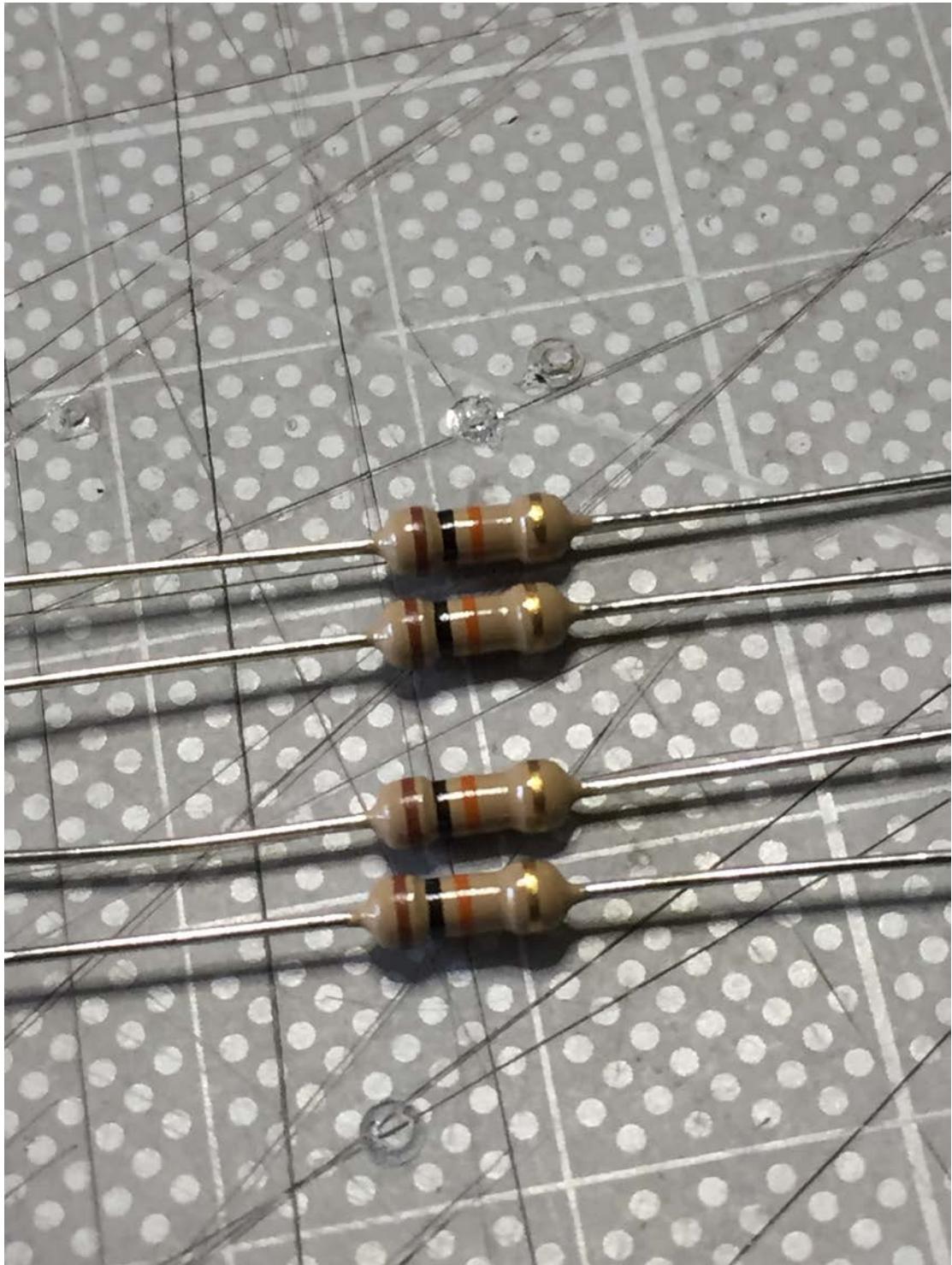



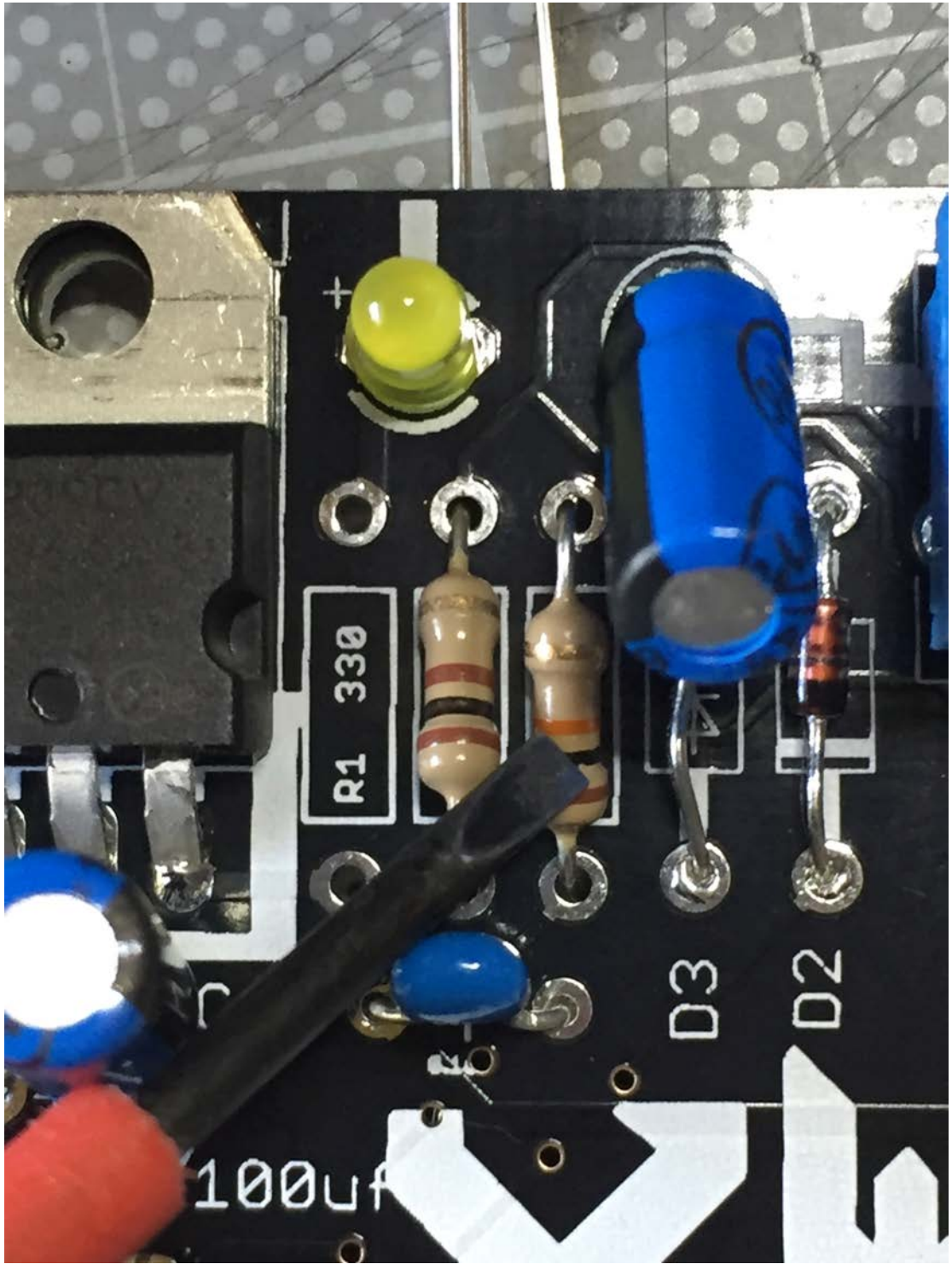

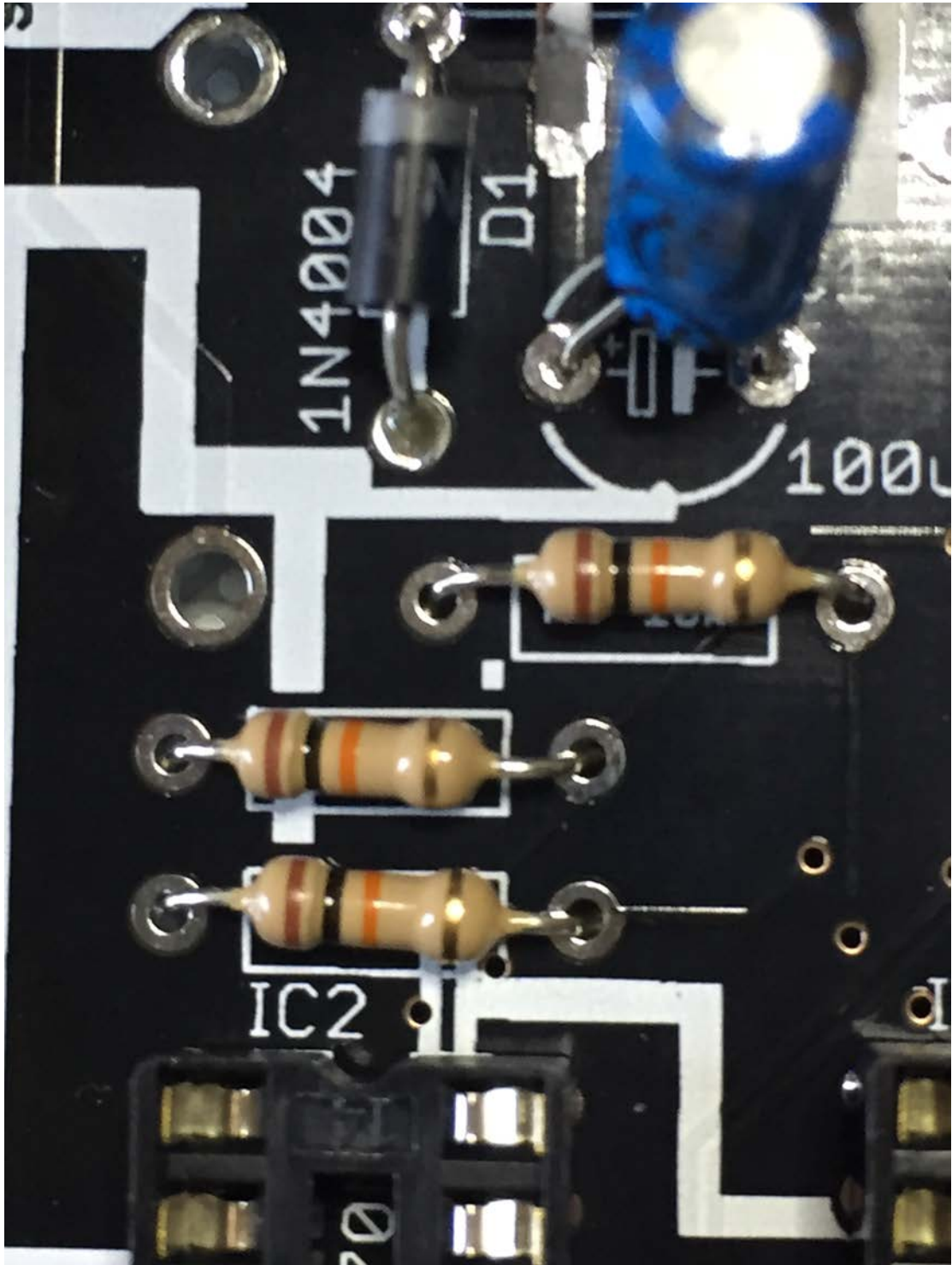

**Add the 330ohm resistors:**

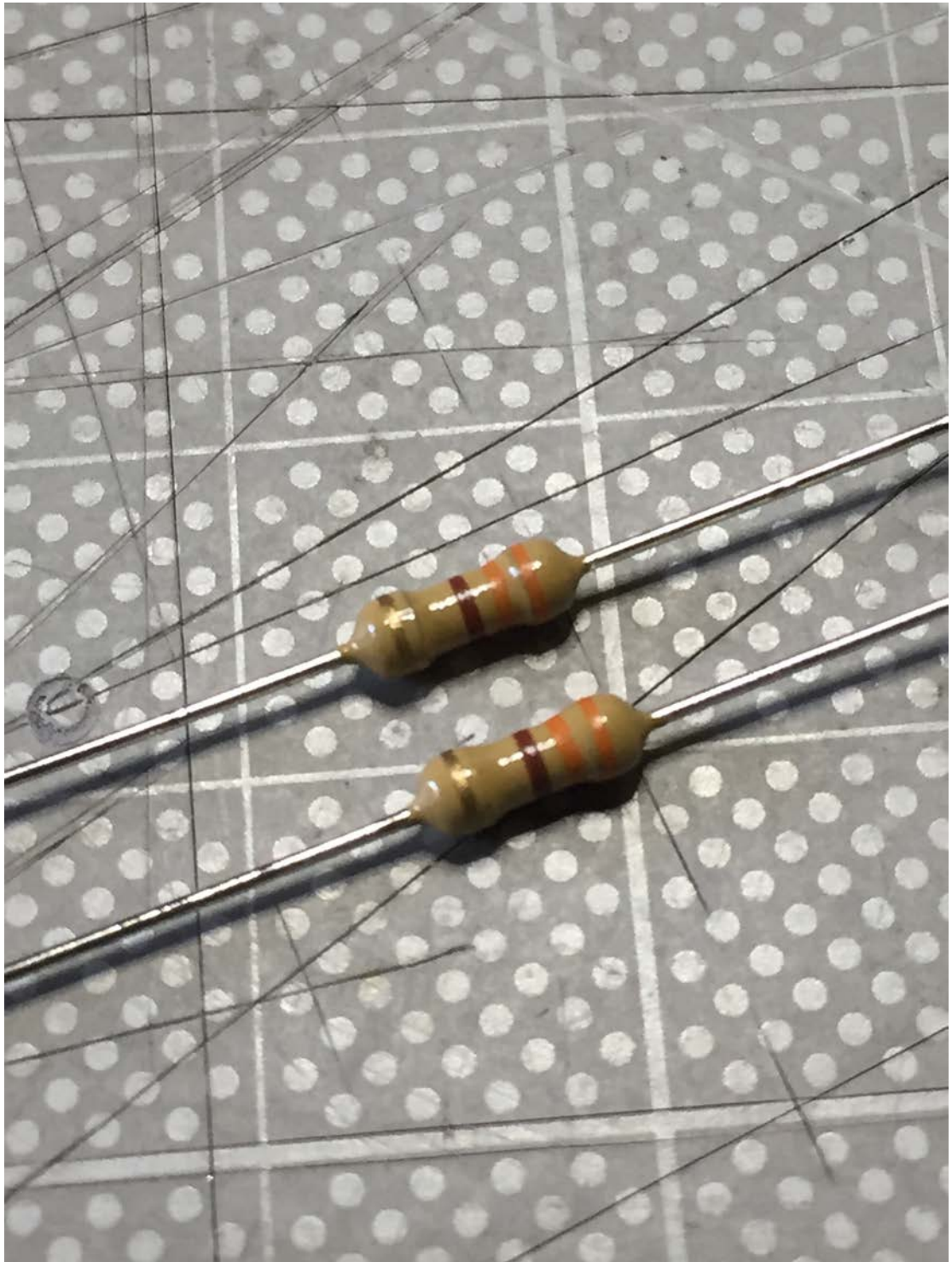



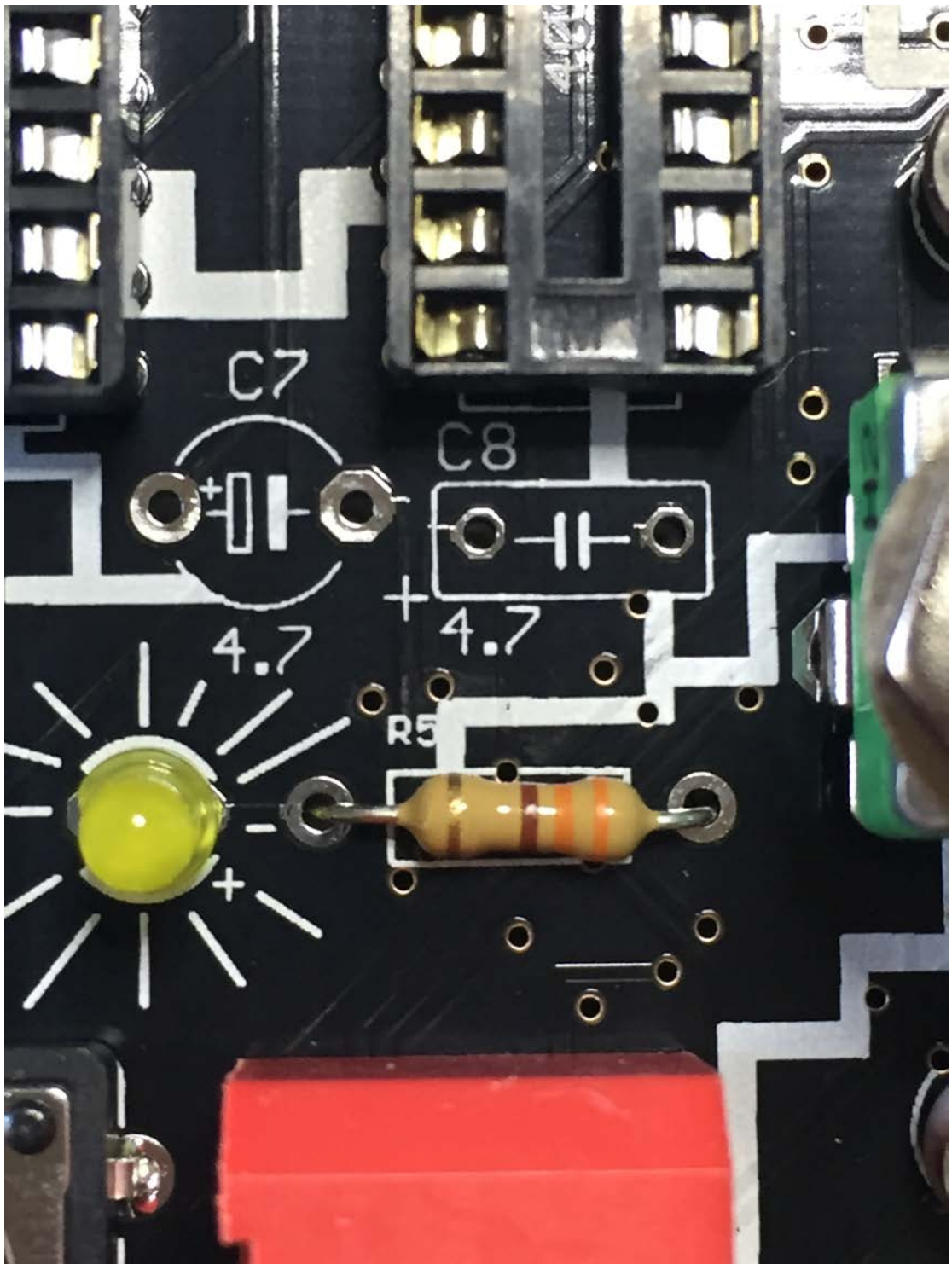

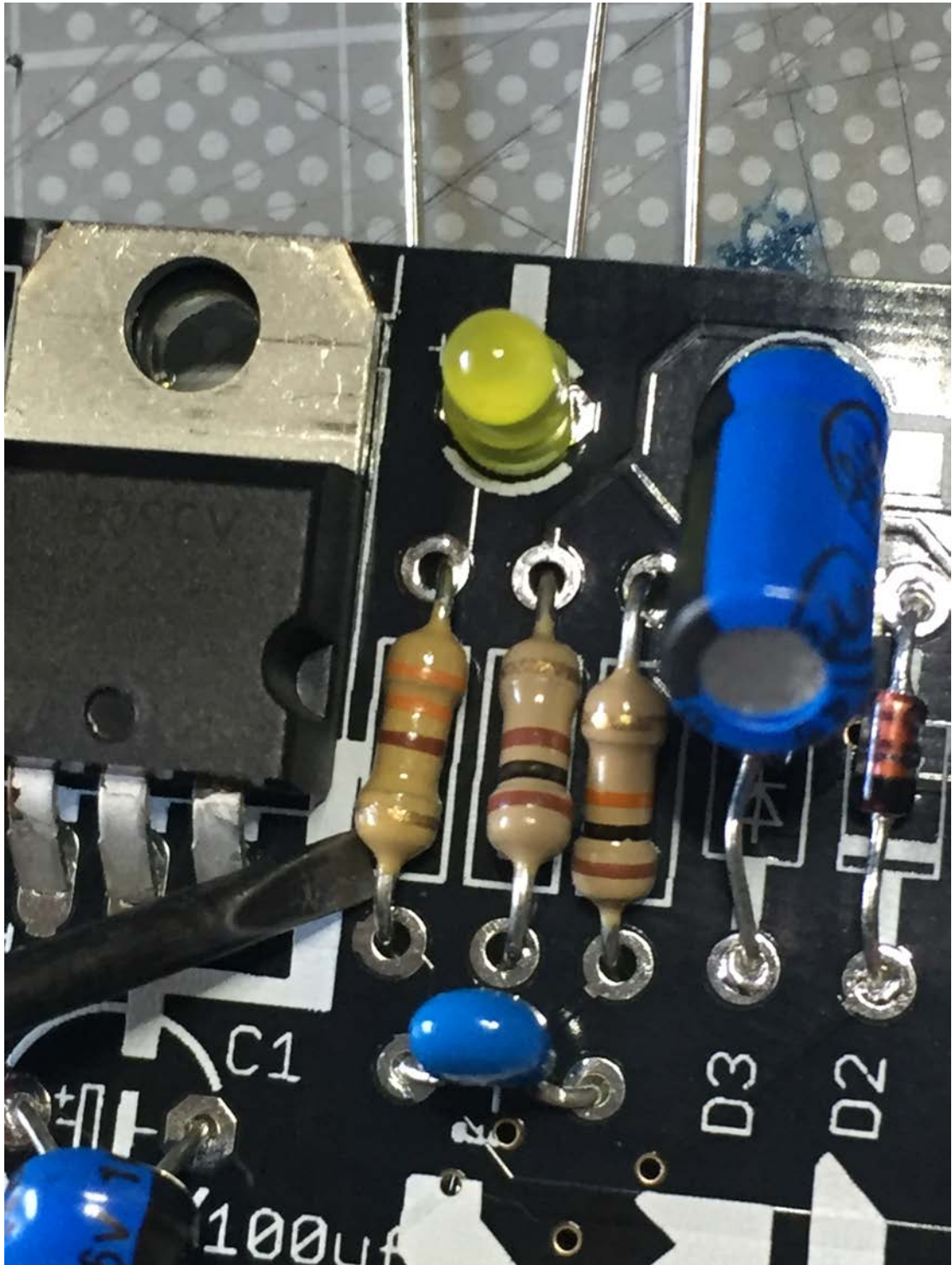

**Add the 4.7uf caps:**







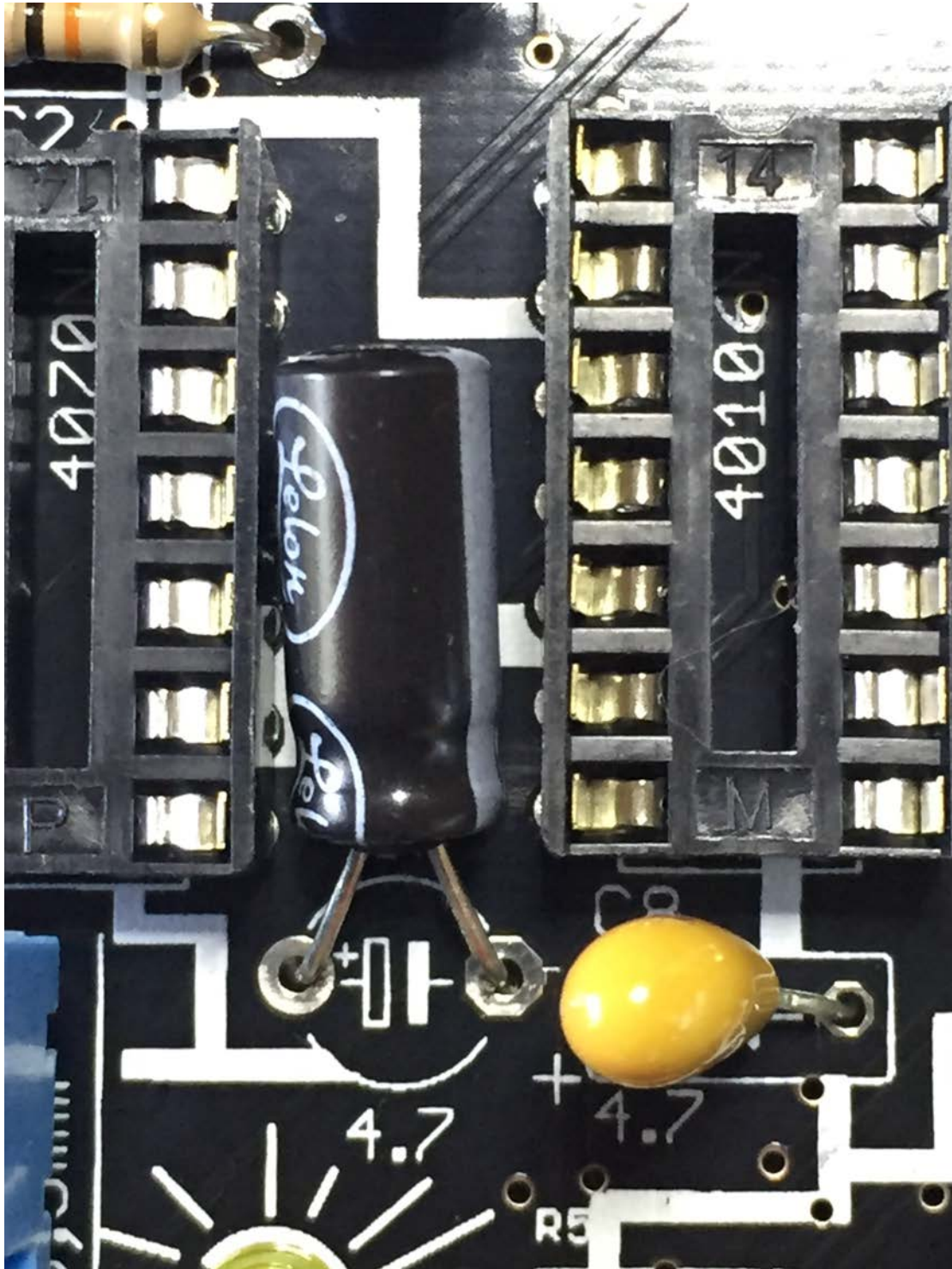

(again the long leg must face towards the + symbol) the black electrolytic cap is the decay for the pseudo envelope, don mix them up or your decay will be so short you wont hear it.)

**SOLDER ALL THIS STUFF IN.**

**TEST THE CIRCUIT:**





If you have a 9v dc centre – power supply you can plug it in and see if the power light comes on. If it does, GREAT!, if not go back and check you have followed all the instructions and soldered all the joints and that there are no shorts where pins on the underside are joined together.

If you don't have a dc power supply you can keep going it will just be harder to fix any mistakes you may have made in the future (not impossible tho)

**Add the CHIPS:**







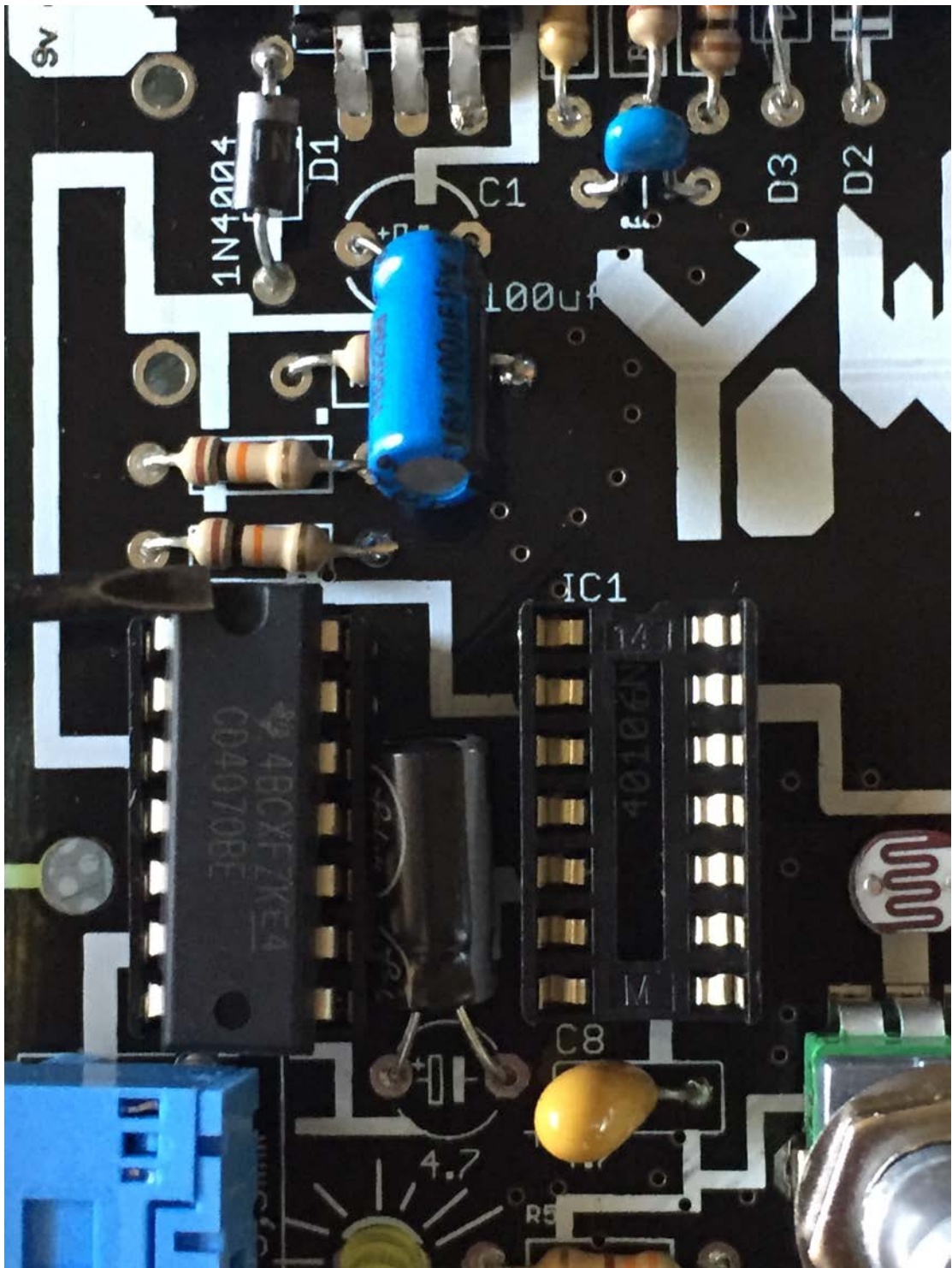



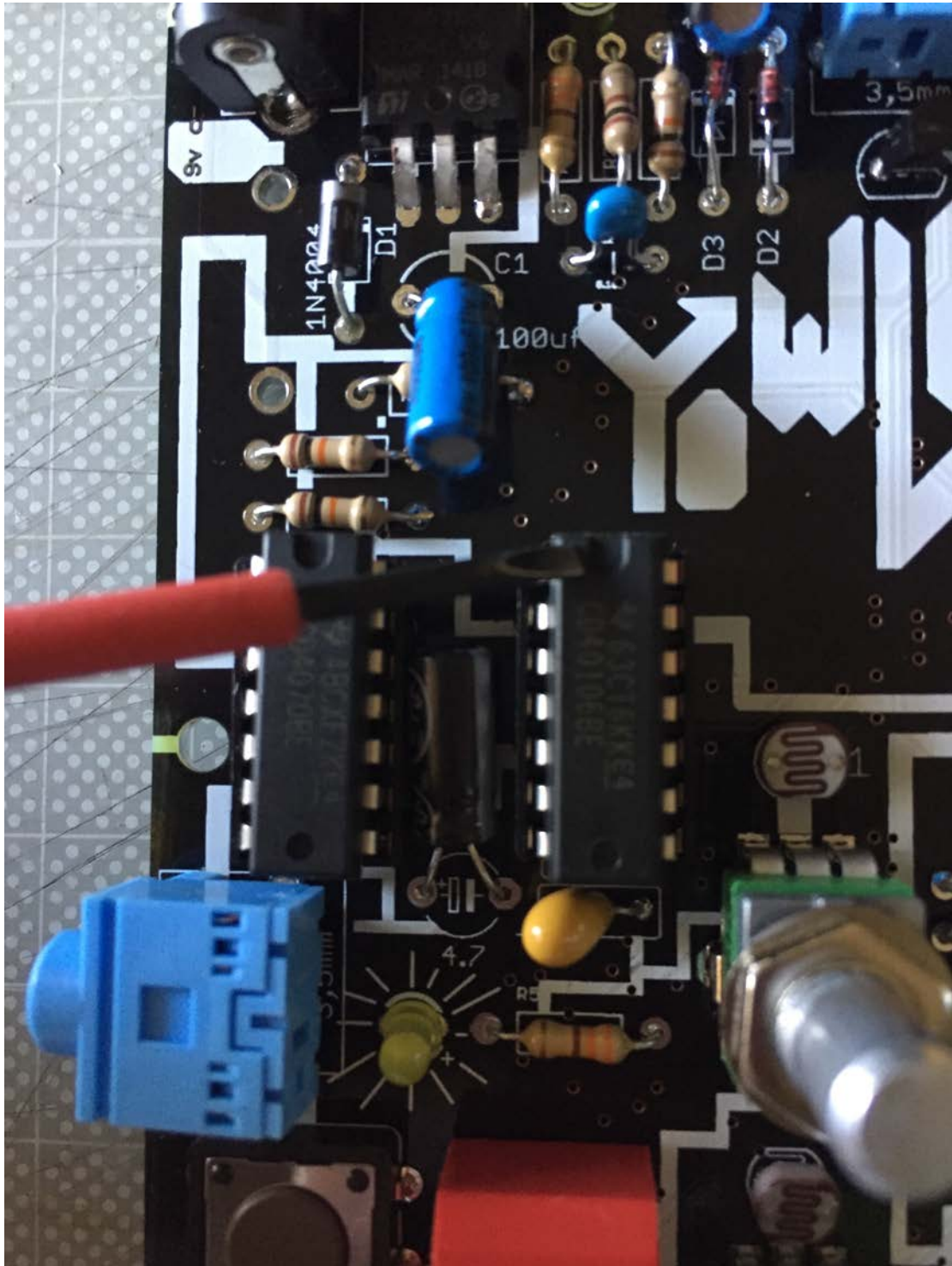

Check that the numbers on the chips match the photos, the 4070 ic goes on the left side closer to the tact button.

**TEST THE CIRCUIT AGAIN:**

Plug it in to the power, see the light next to the power regulator come on, then plug in headphones or an amp or a stereo into the Yowler.

**YOU WILL MOST LIKELY NOT HEAR ANYTHING!!!!!**



the volume may be turned down, turn it to the mid point.

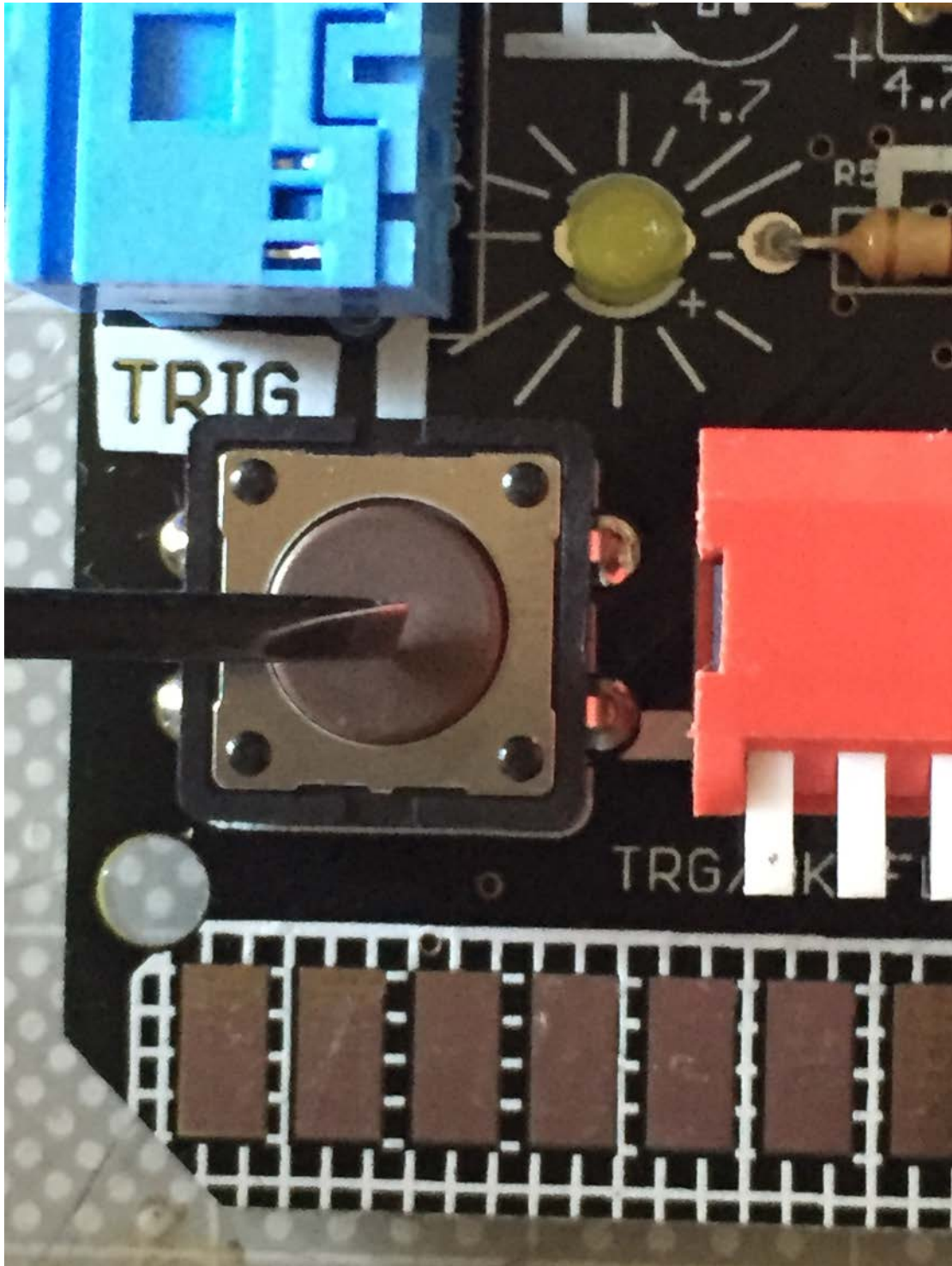

second reason there is no sound, you are in trigger mode, press this button, and you should hear the unit make noise.



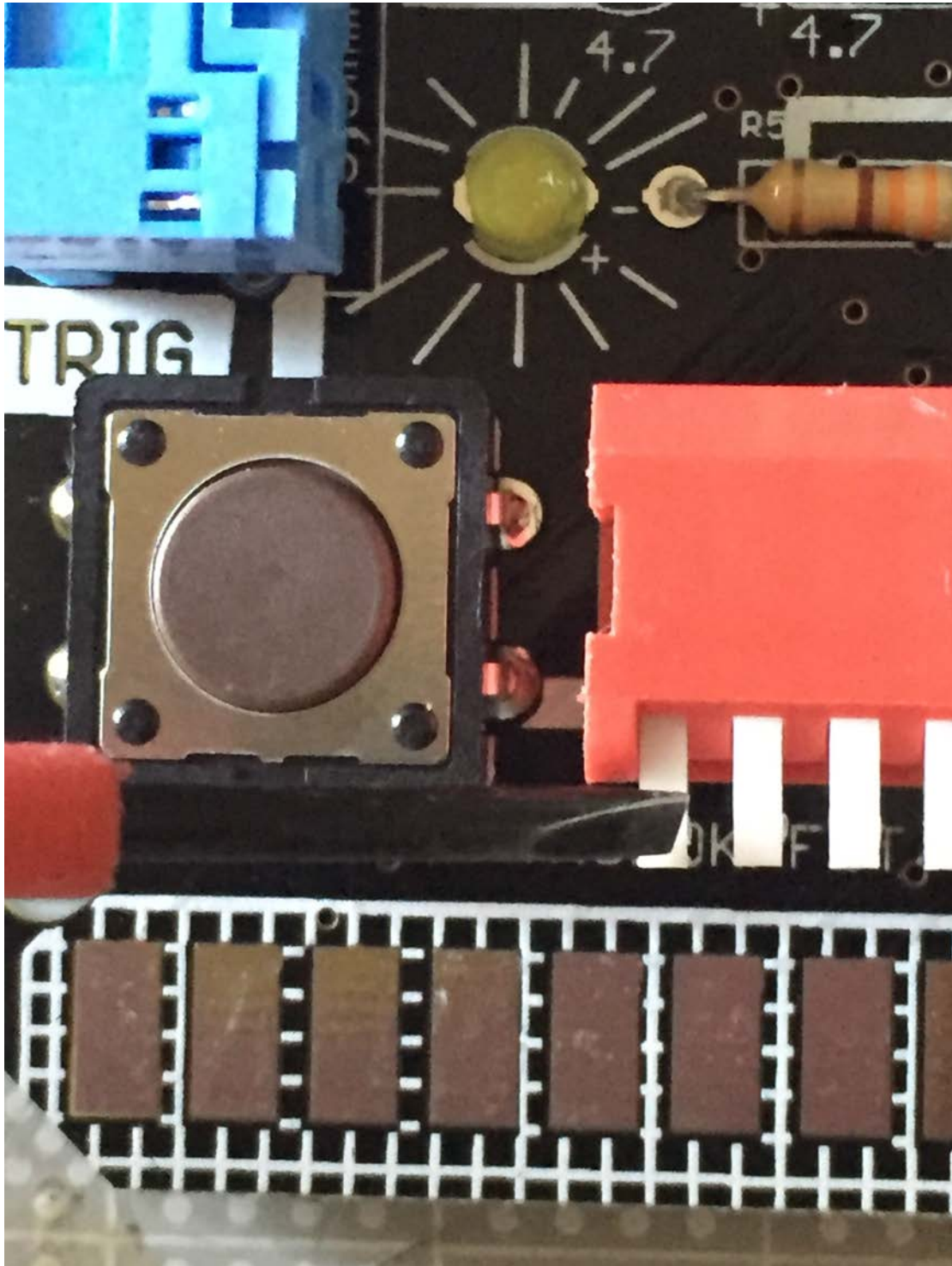

for sustained sound push this switch down.

If you only hear audio in one ear, that is because the unit is set to MONO mode, for stereo mode push down the stereo switch on the other end of this DIP switch. Switch all the switches and play with the knobs to make sure it looks like it is all working. If you are unsure of any of the functions or it seems like a knob is not working, check the 1 page manual, you may have that oscillator switched off.

**Add the 9v battery clasp: (but don't solder till you have followed all the steps)**



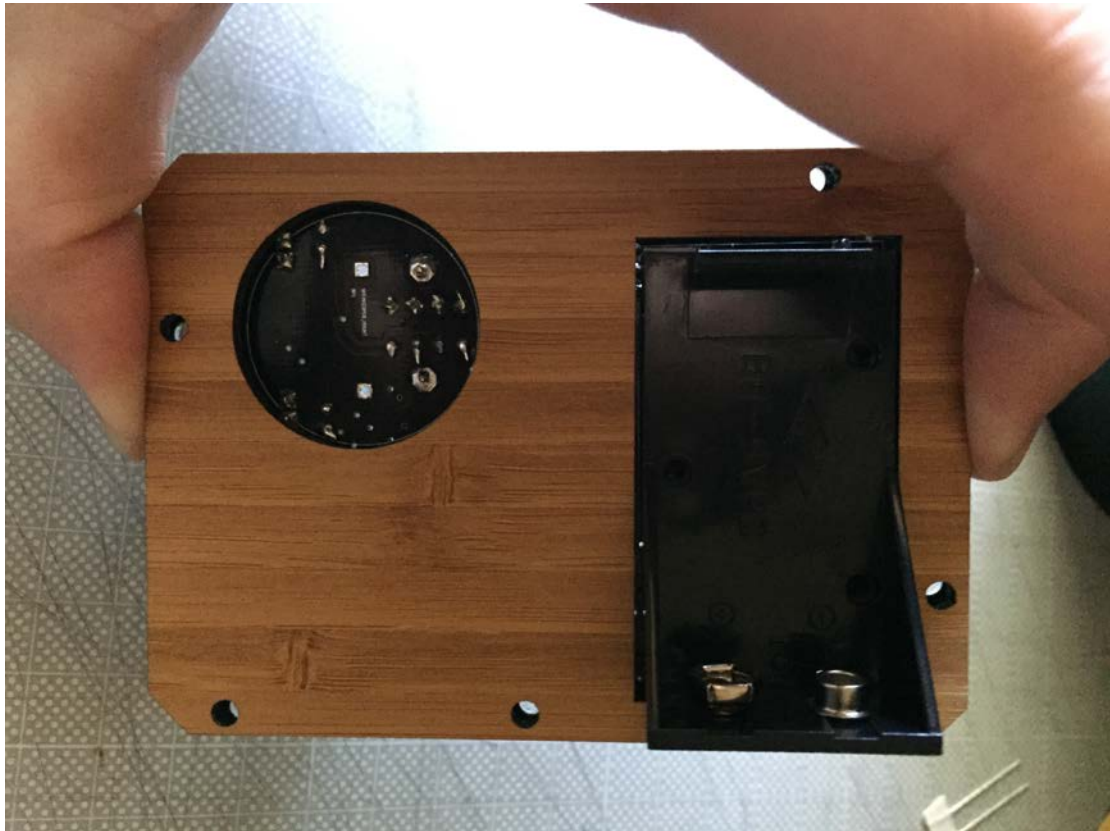

put on the back plate to make sure you have the battery clasp lined up







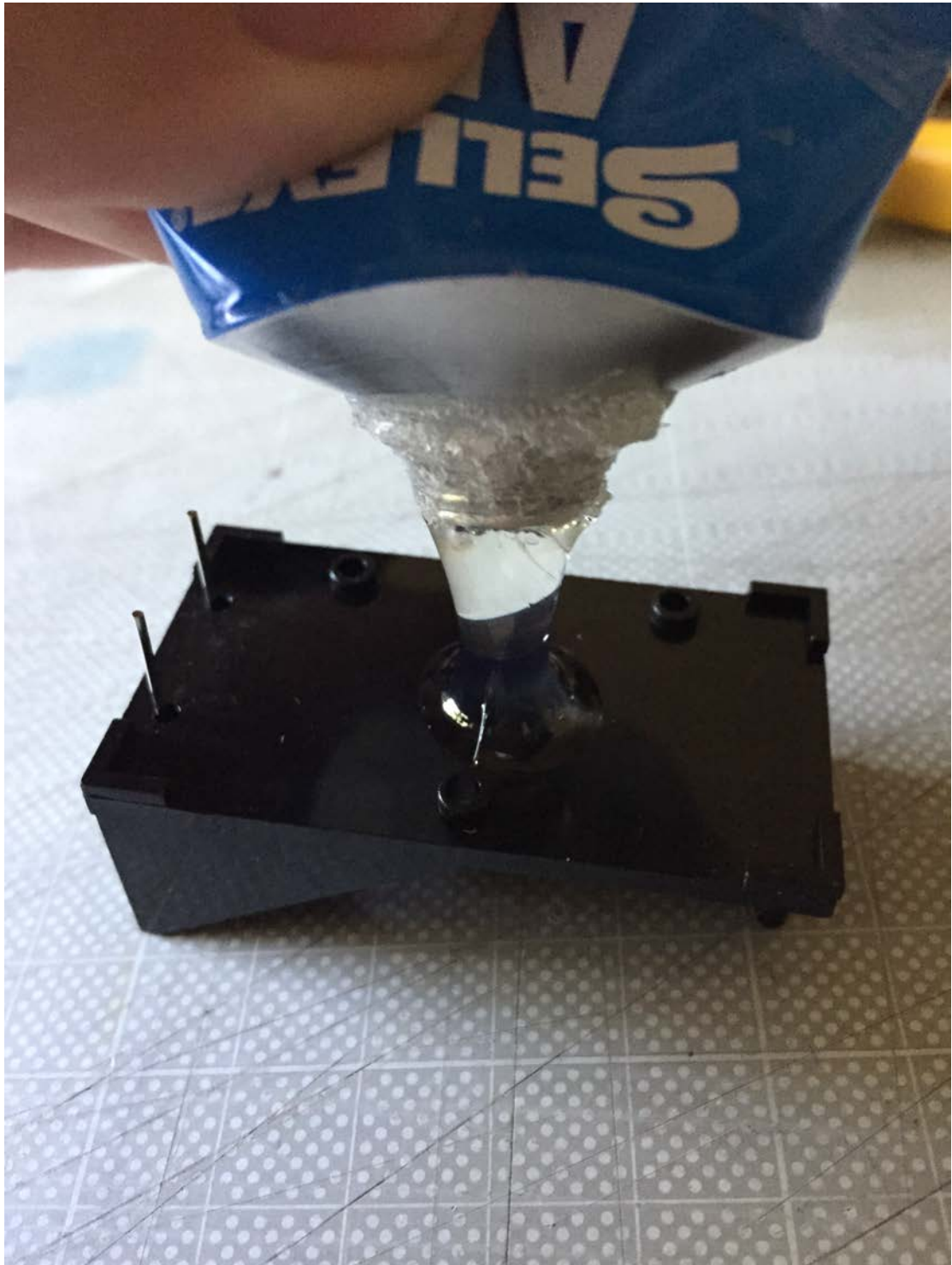

now put your tape or adhesive on the back of the battery clasp.



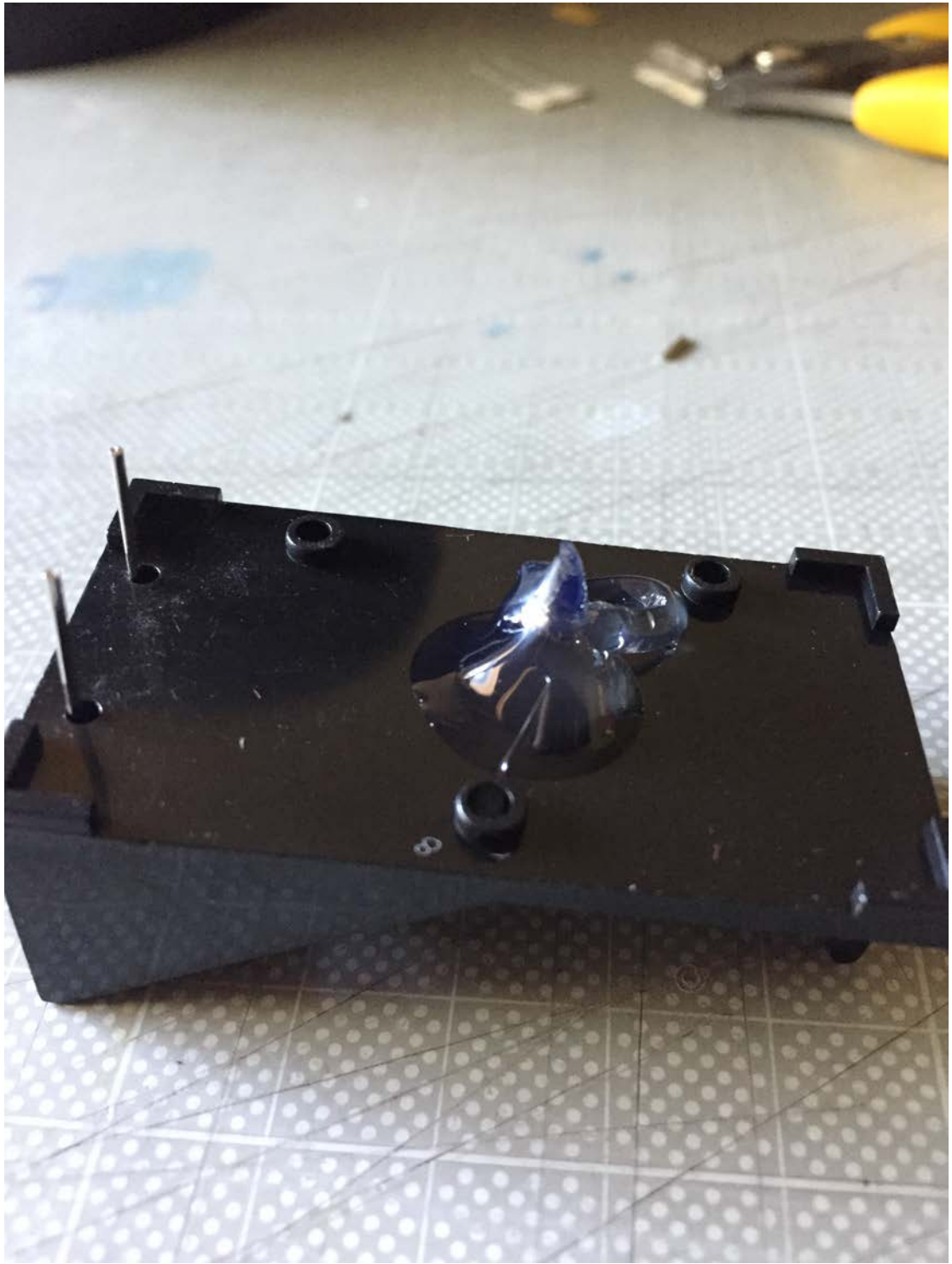

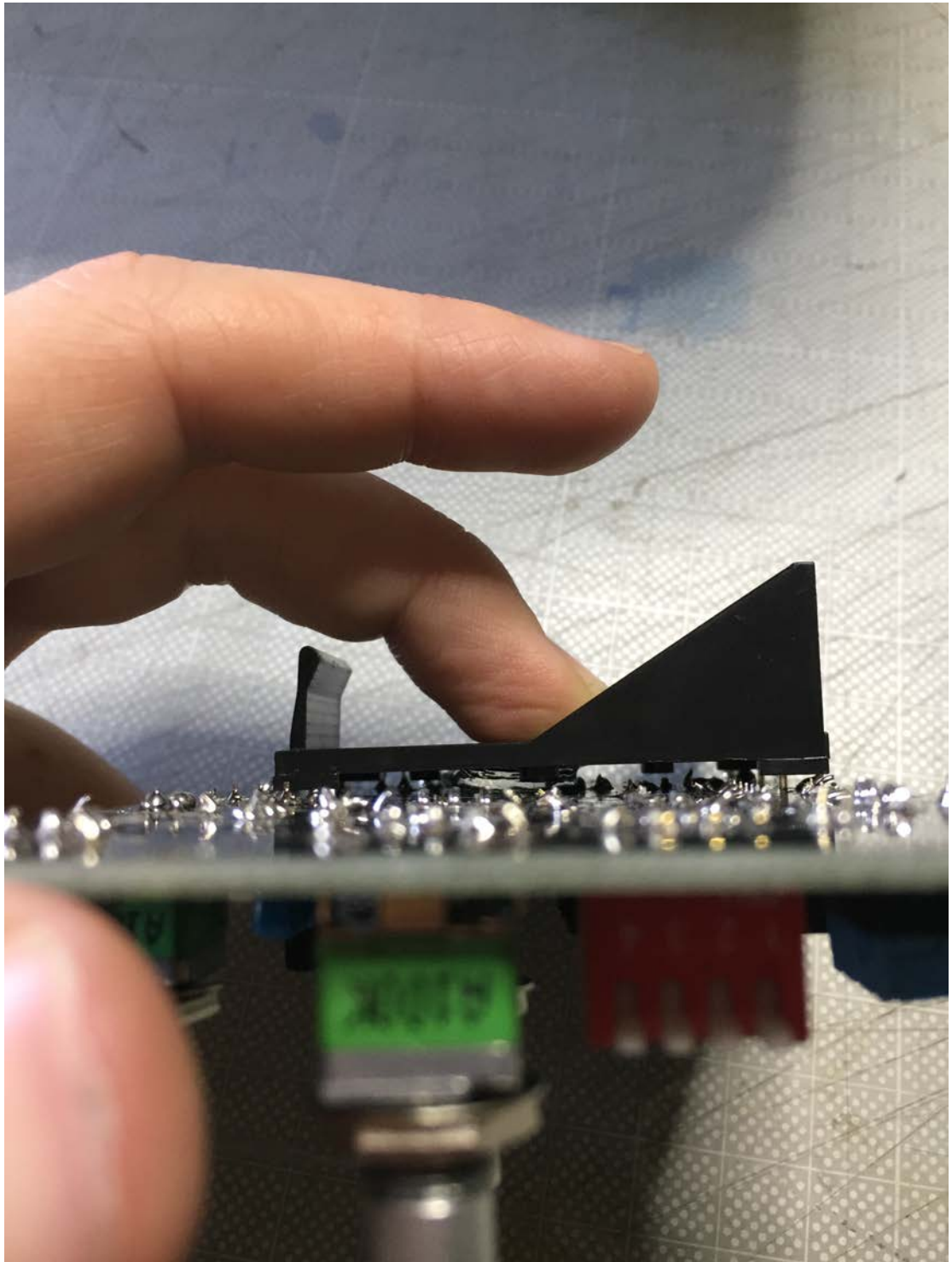

put it in place on the back of the circuit board, using the wooden back as a guide to keep it lined up.



Solder in place.

**Add the speaker:**



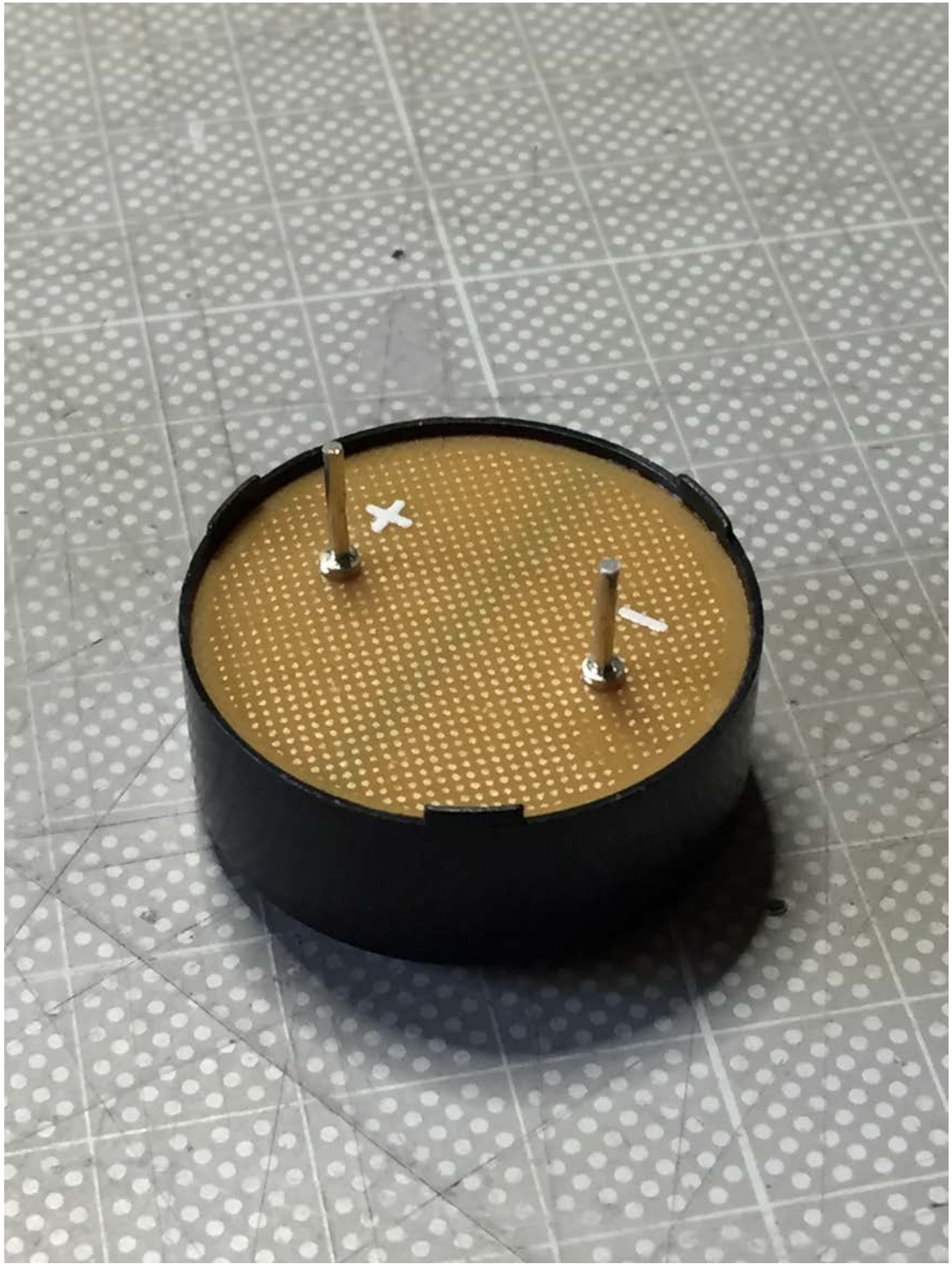

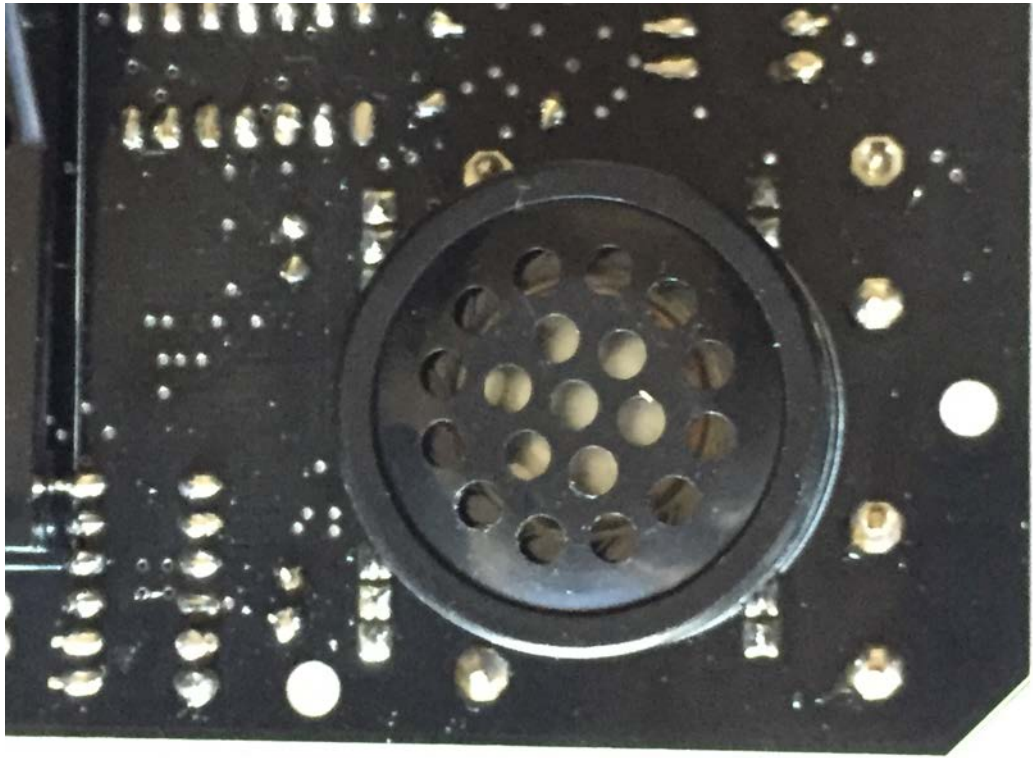

Don't worry about the + and - on it, its not important in this case.

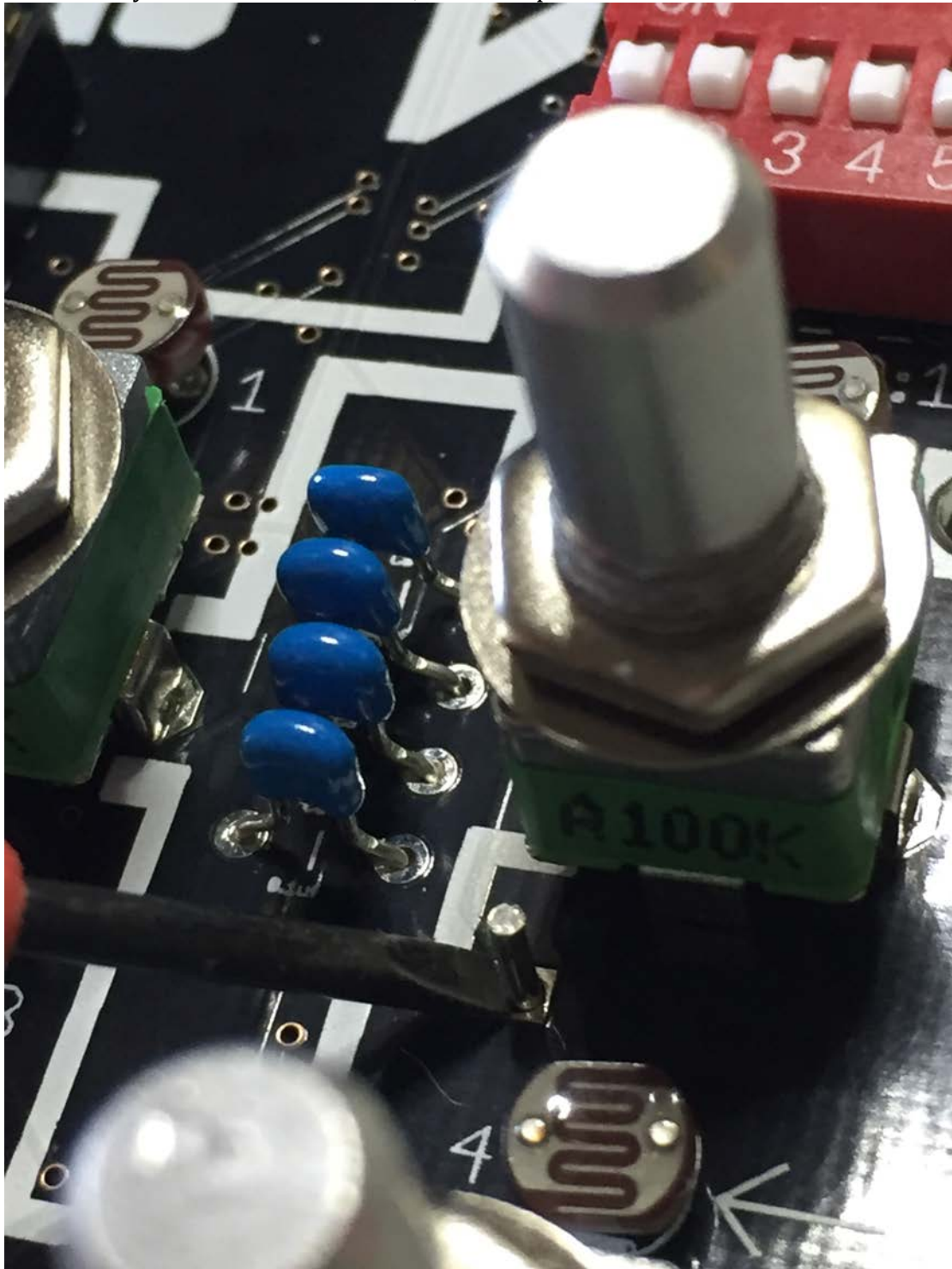

Solder the pins where they stick though the PCB, this is a bit tricky, so be careful.



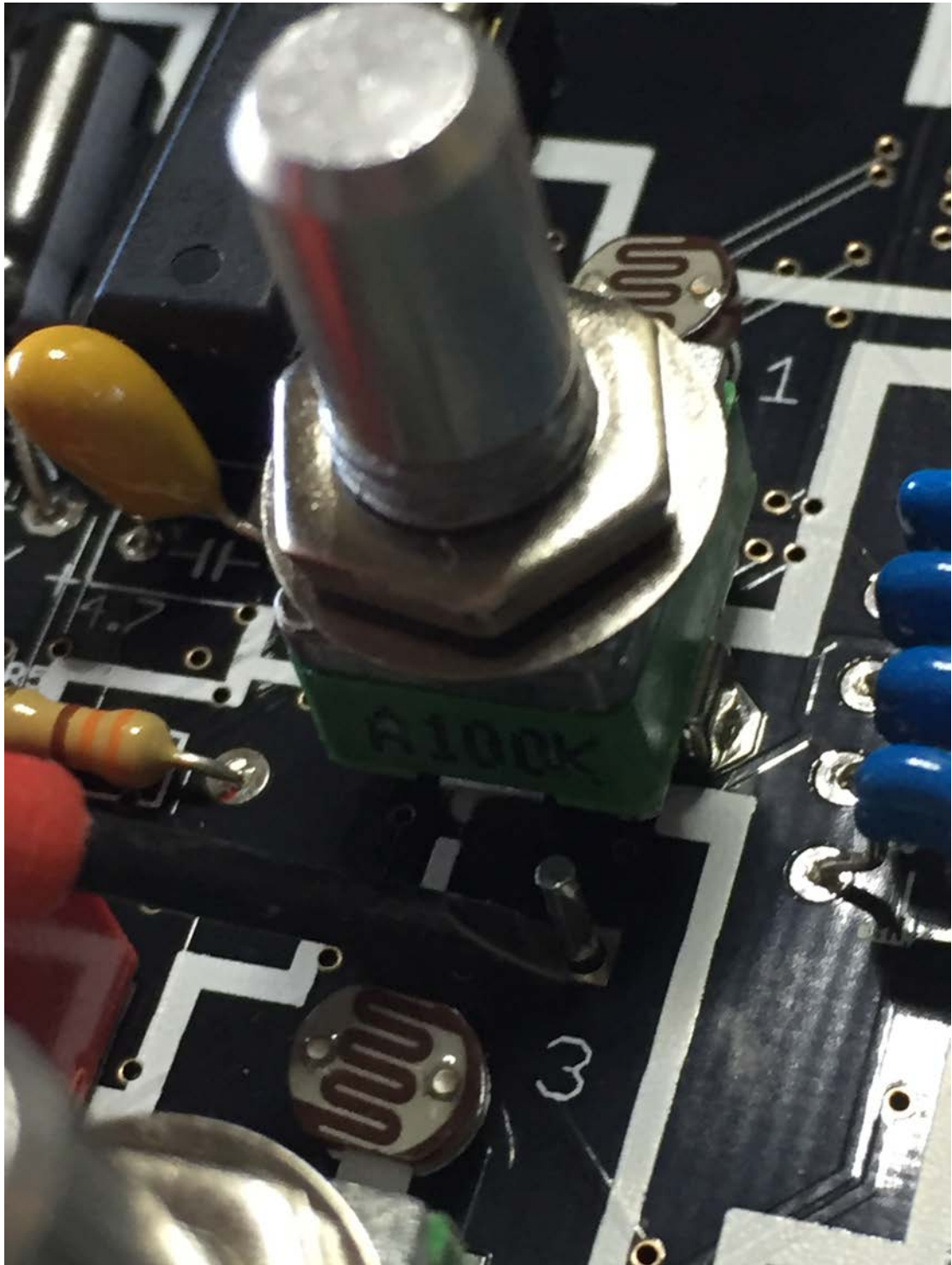

**Add the case:**



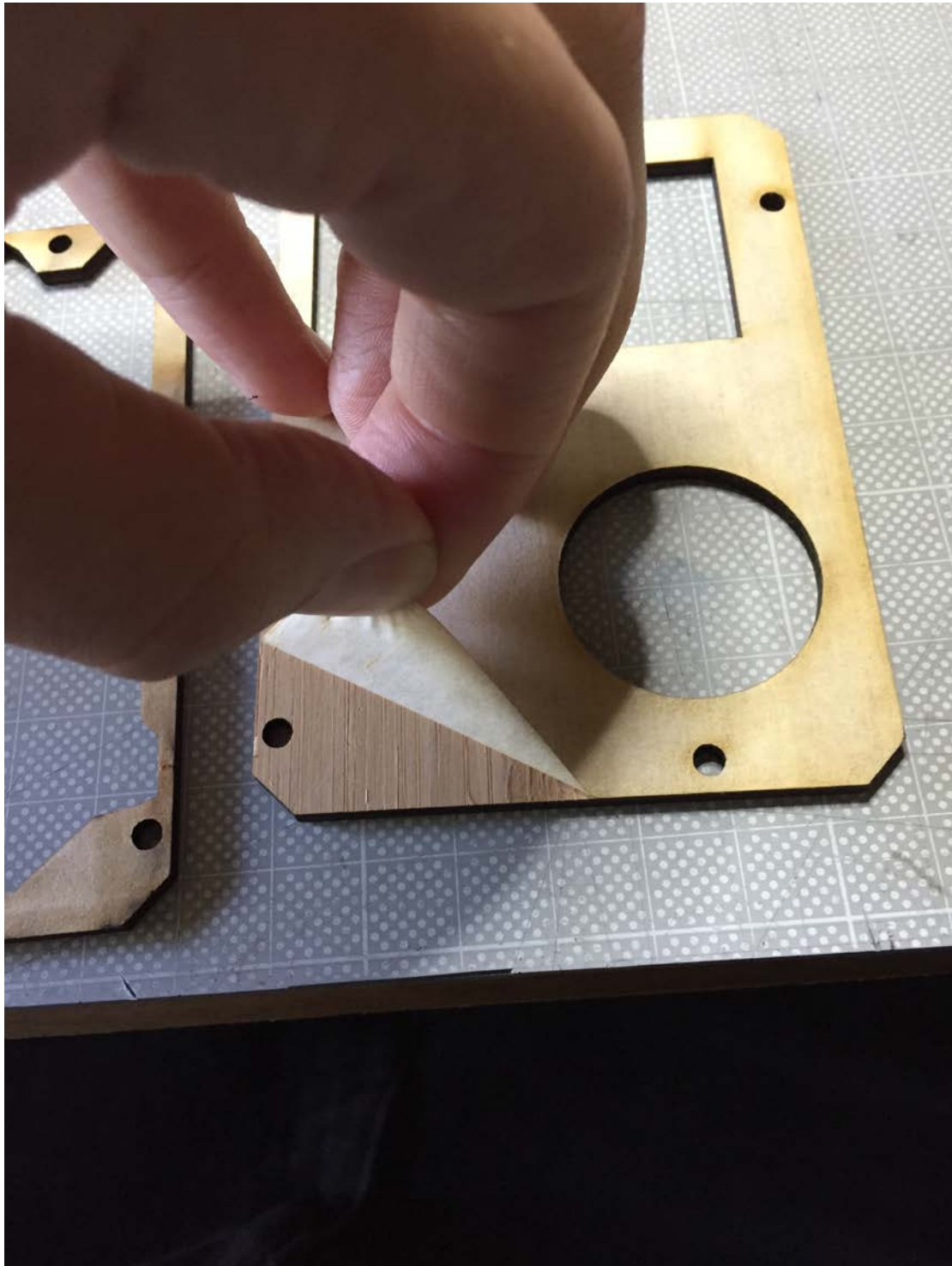

Peel off the protective coating on this piece only. Here is where you can treat the wood if you want. Sand it with a very fine grade sandpaper, you can oil it, varnish it, stain it, paint it. Do whatever you want to it.





here is a sanded piece that has had 3-4 layers of linseed oil applied to it.

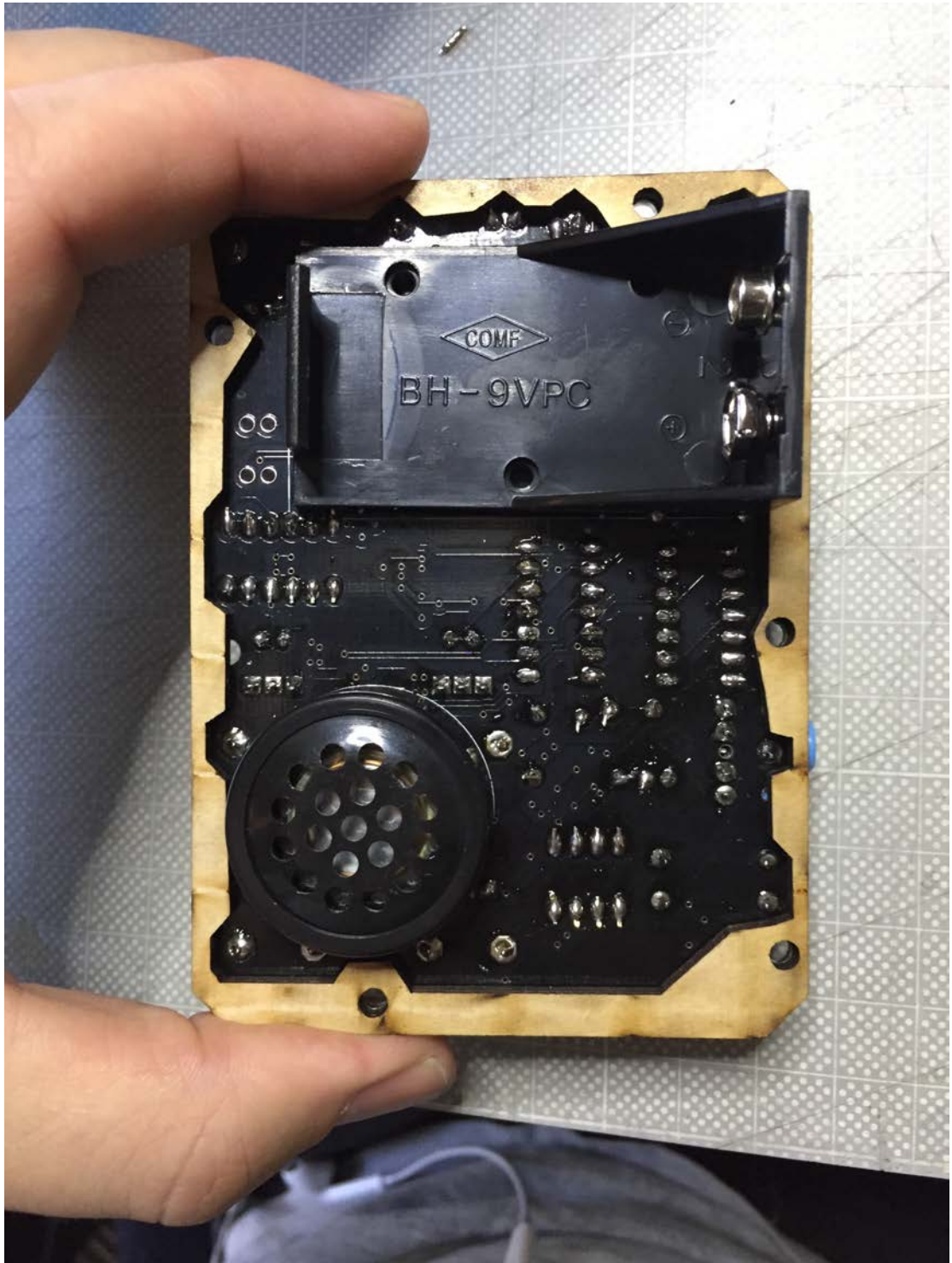







Put the pieces on the back.



Take you long bolts and put them through the case and PCB and put nuts on the other side.

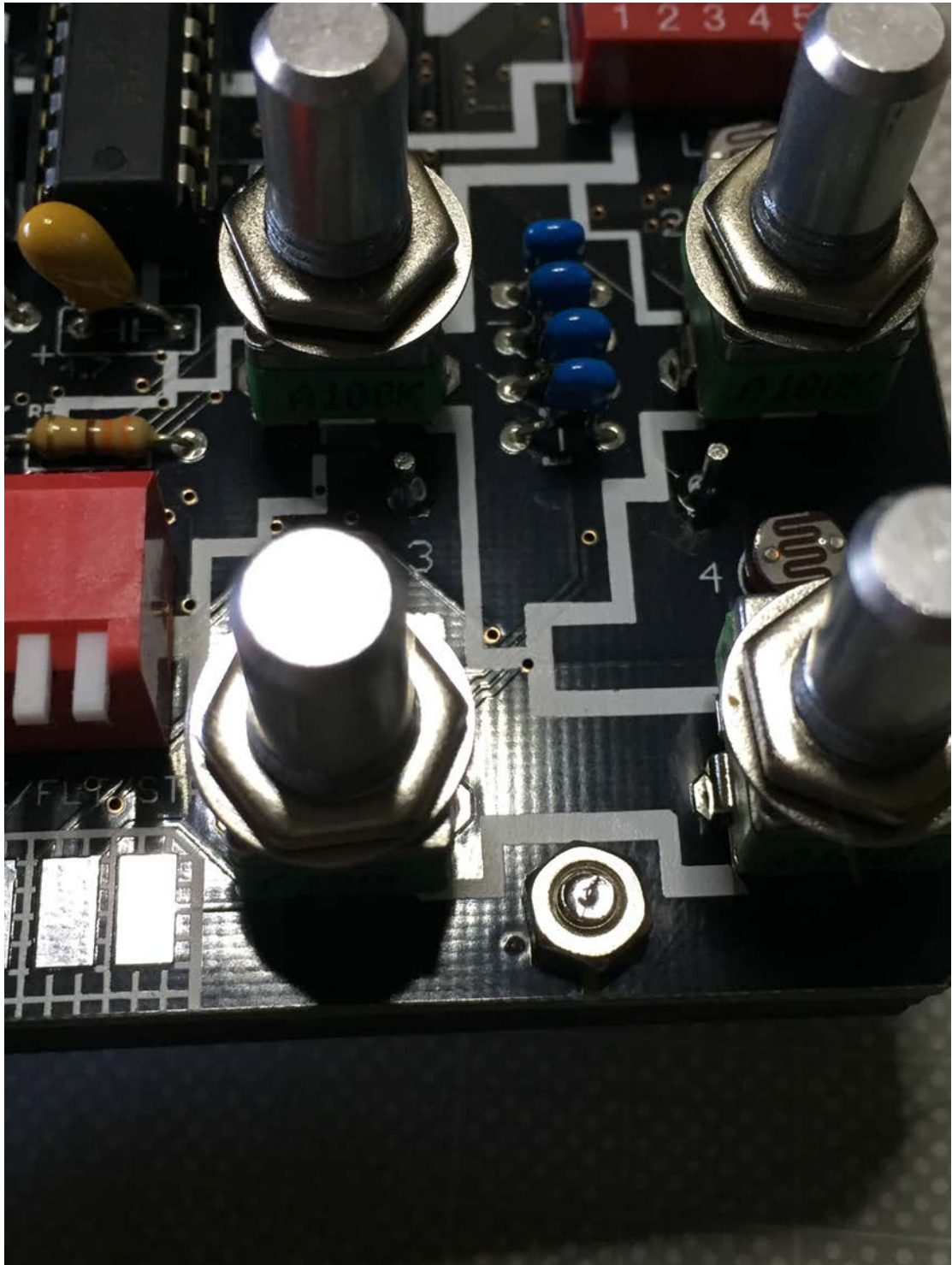



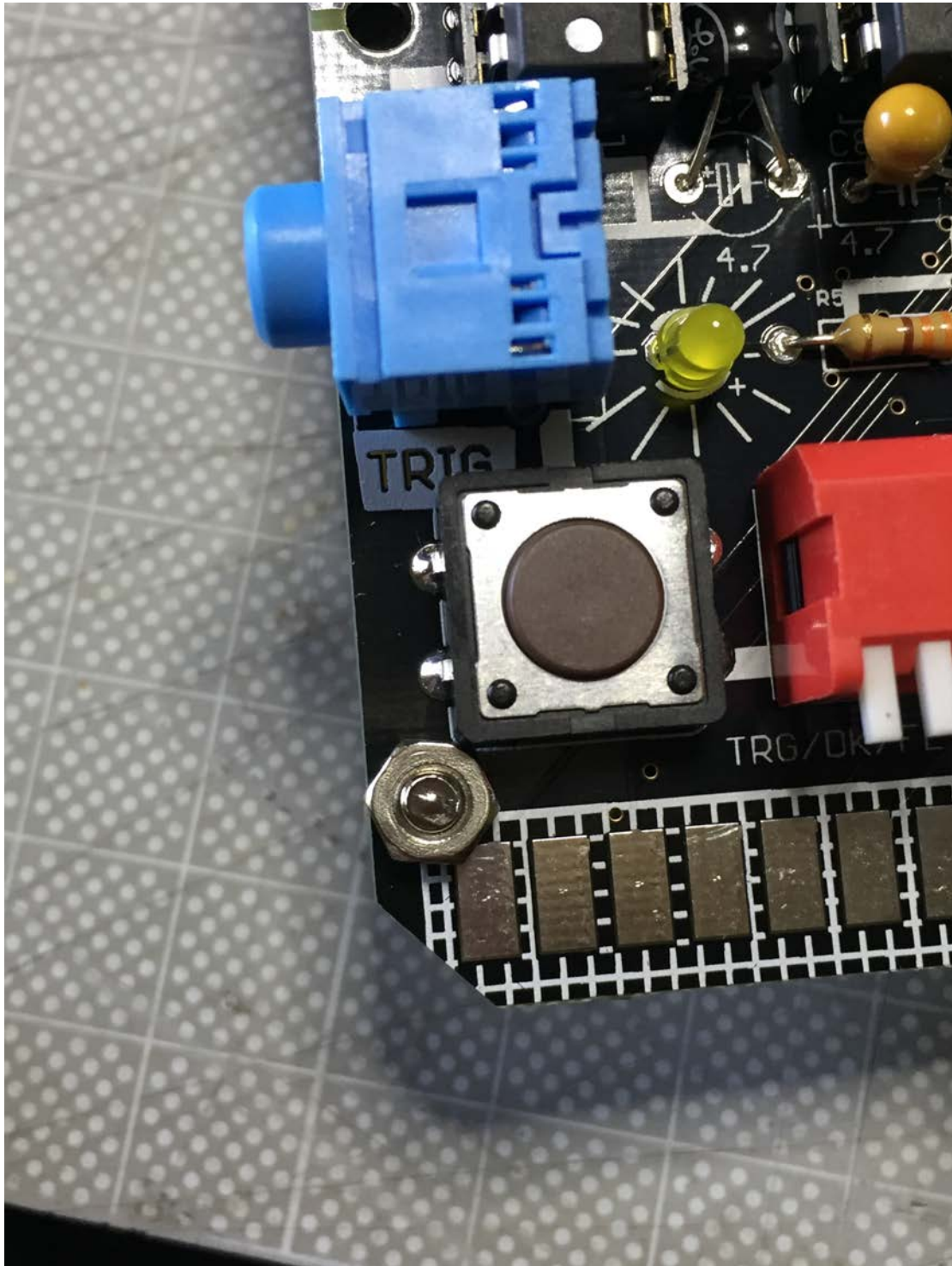

**IF YOU DON'T HAVE THE EXPANDER TOP THEN PUT NUTS ON ALL OF THE BOLTS AND YOU ARE DONE!!!! YAY!!!**

**If you have the EXPANDER top then you will need to do this:**



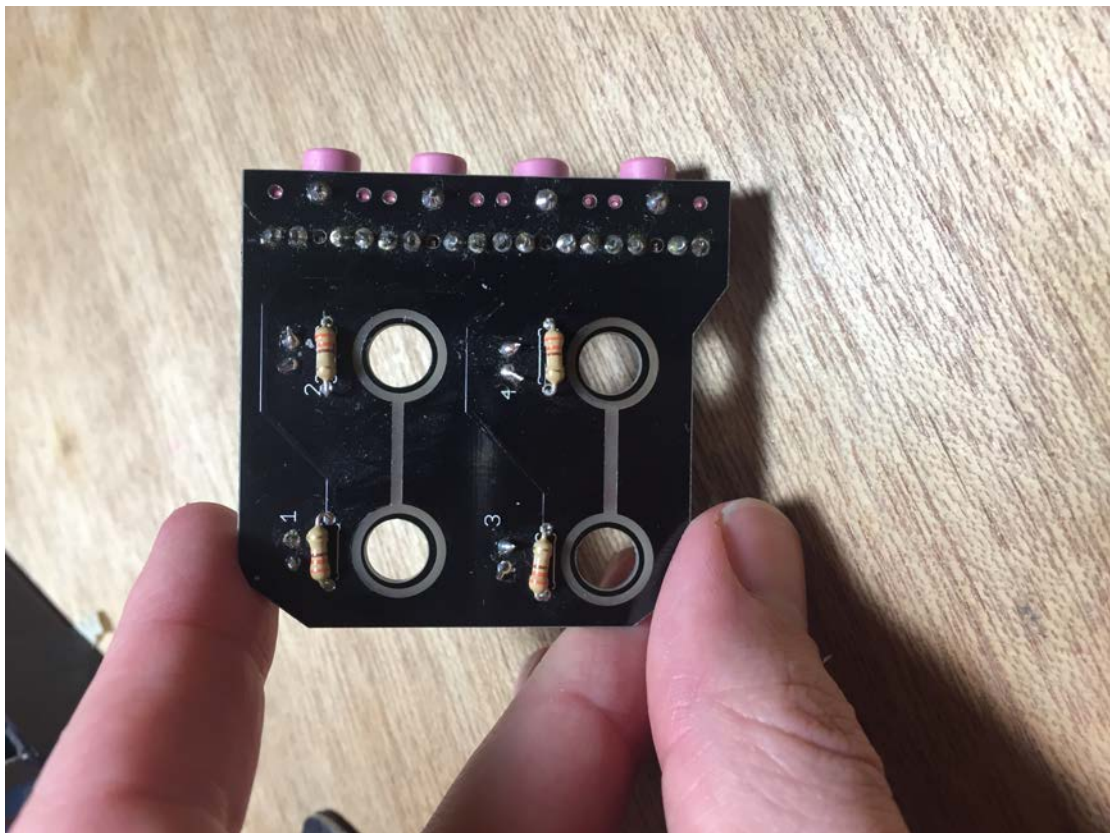
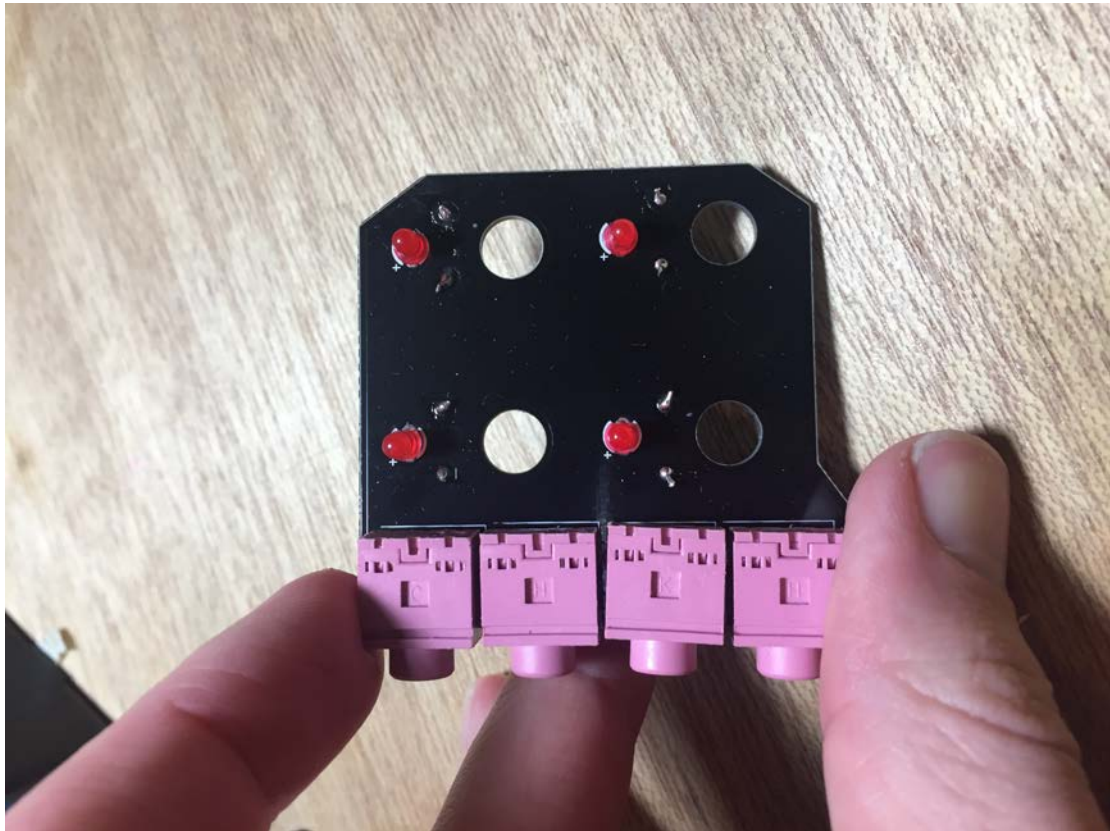

**Pretty simple here, 4 x audio jacks, 4 x leds and 4x 330ohm resistors, solder them all to the EXPANDER PCB and you are done.**

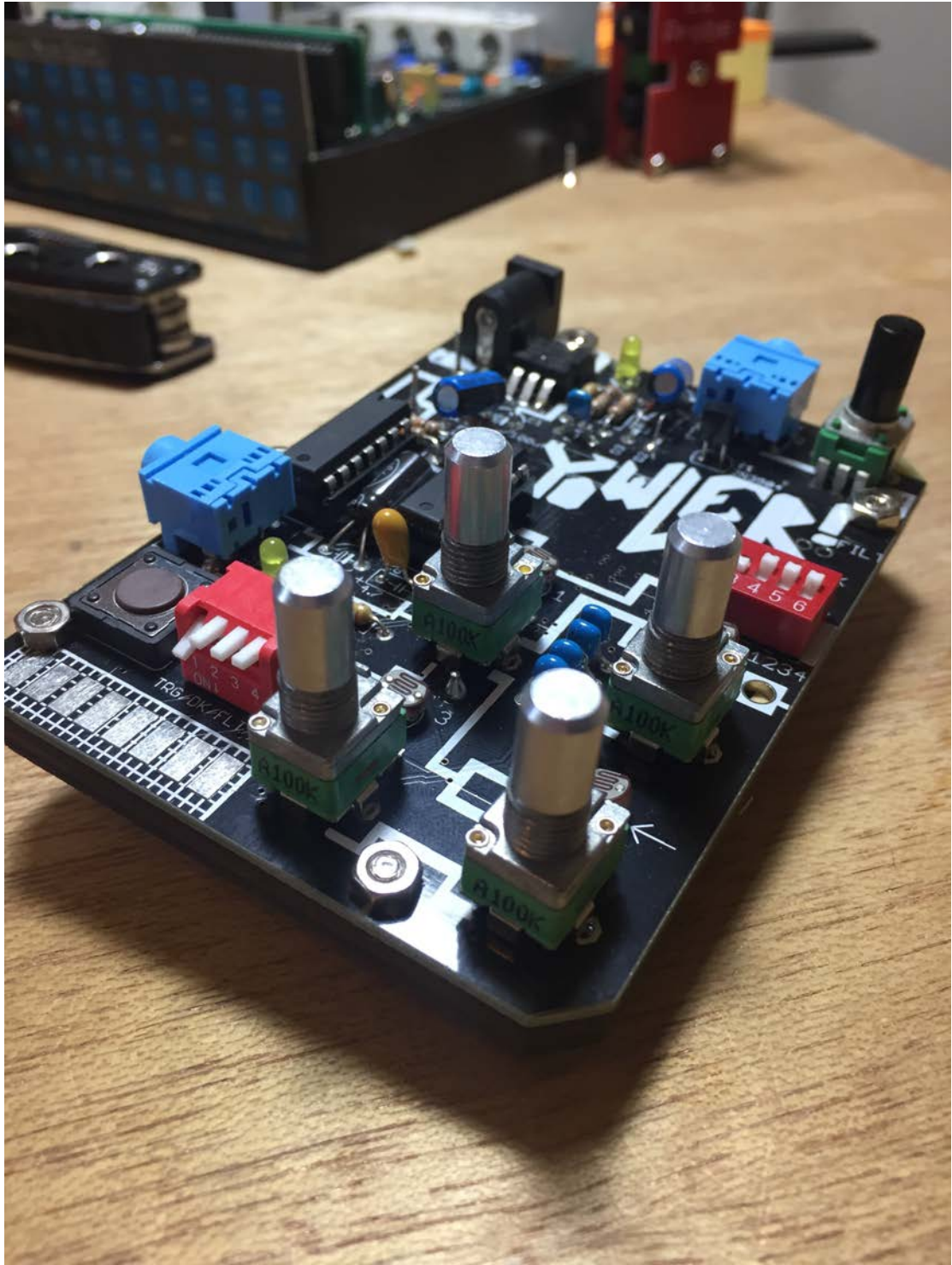



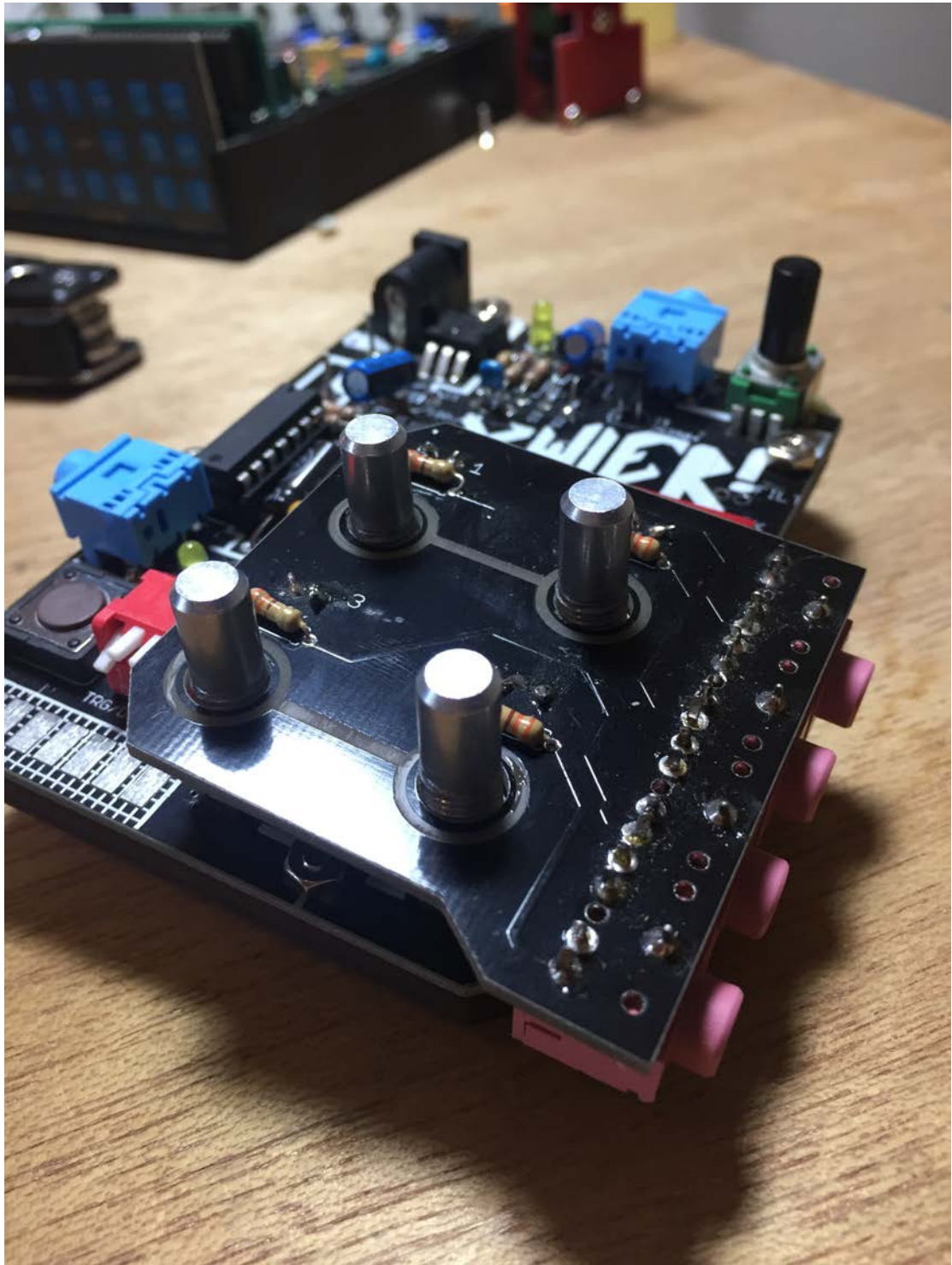



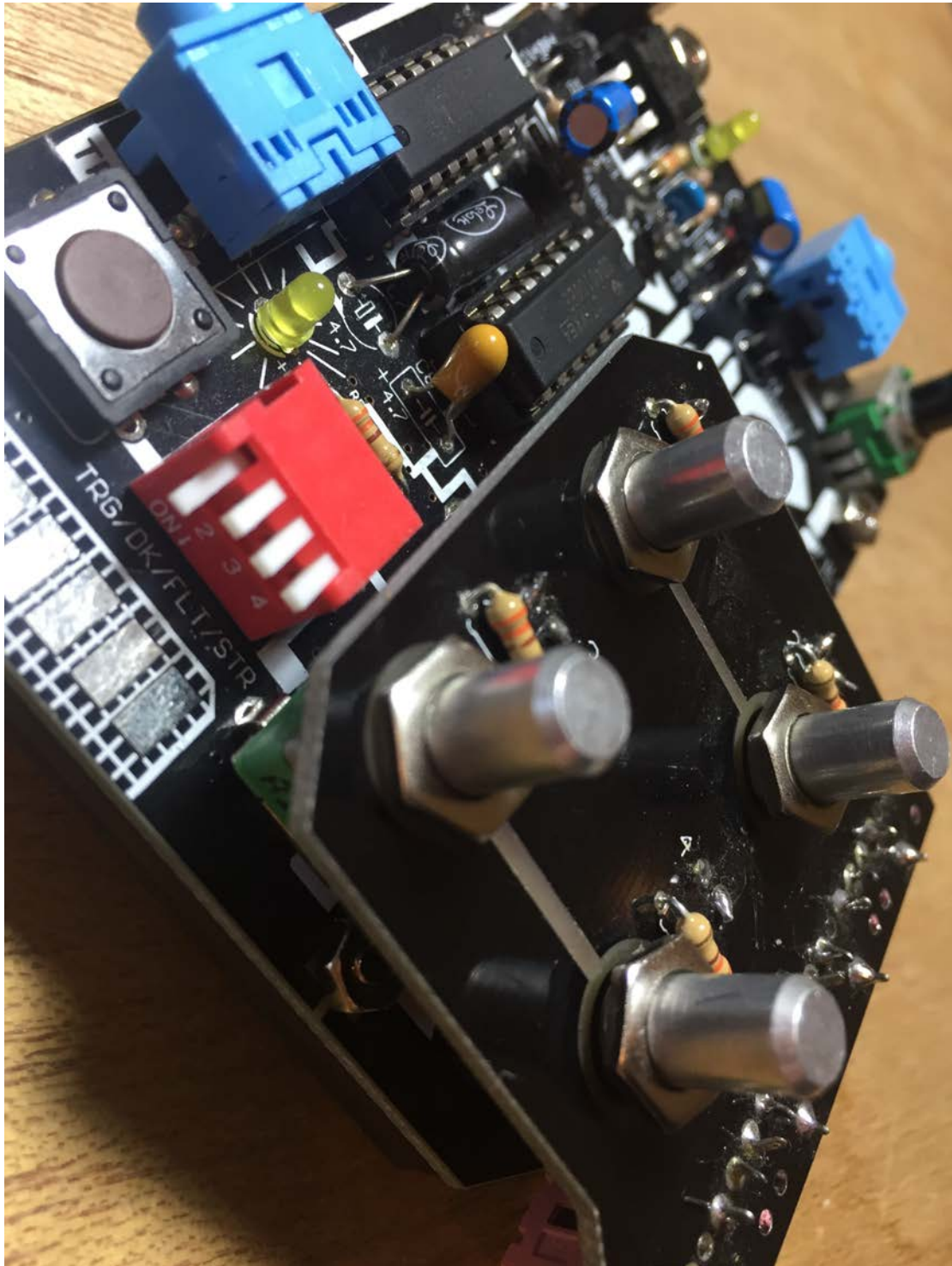

Take off the nuts on the pots and slide the PCB EXPANDER down over them. (if your knobs are not totally straight **\*story of my life\*** you will need to jiggle a bit, be careful of the EXPANDER tho)

Use the nuts and washers from the pots to attach the EXPANDER firmly.





on your knobs loosen these grub nuts

Turn all your pots all the way to the left



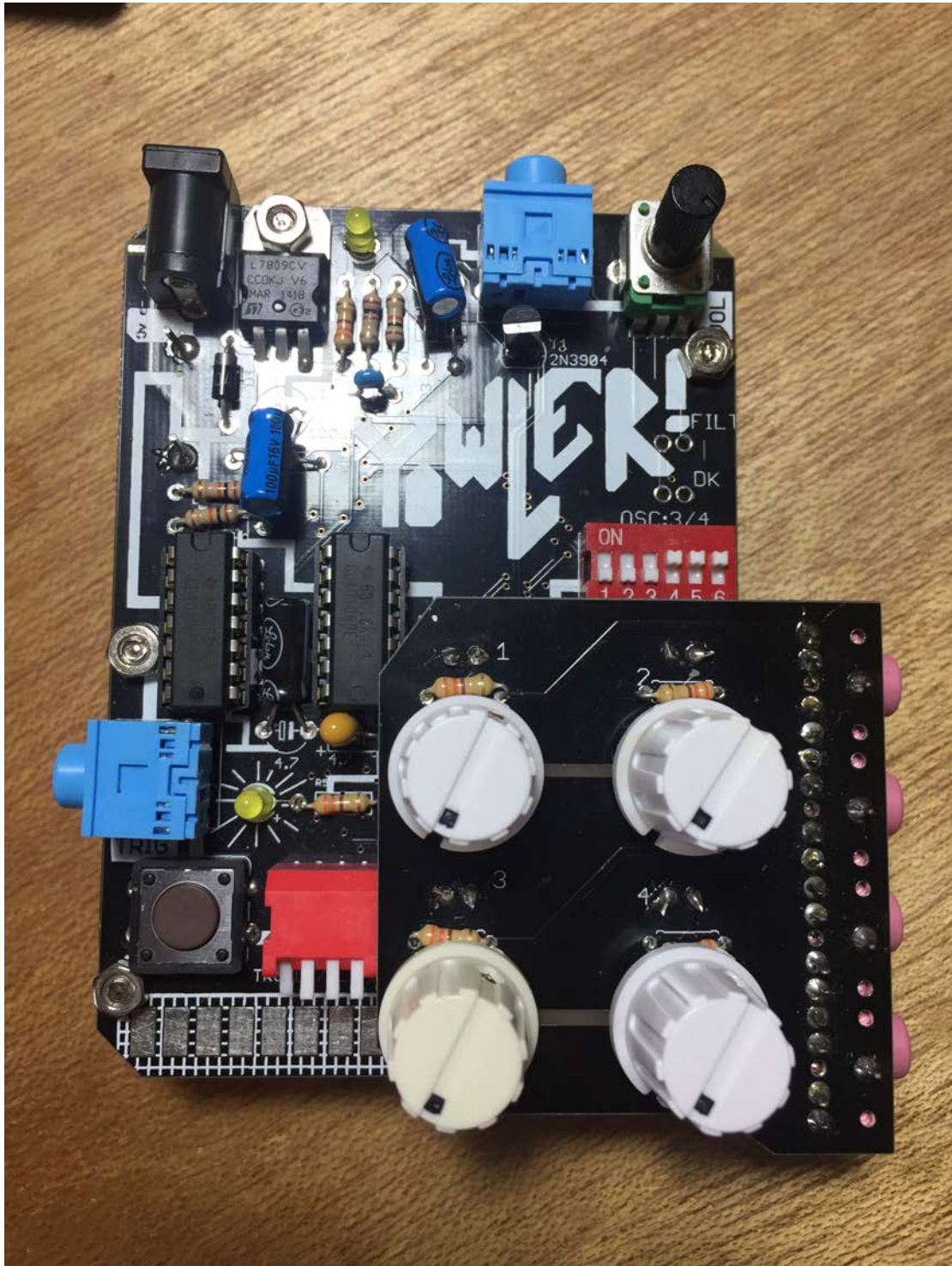

put on the knobs facing to the bottom left position. And tighten them. Make sure that the top right knob is not too far down the shaft or it will brush the Perspex.

**NOW YOU ARE DONE!!!!!!!**