

*Fitzgreyve*

**Polymoog Resonator**

**Euro format (14hp)**

**Version 1.9**



## Table of Contents

Introduction .....	3
Options (read me first!) .....	4
“Vintage” or “modern” build: .....	4
Level Matching.....	4
Gain and clipping.....	5
PCB Versions .....	6
Power Consumption .....	6
PCBs.....	6
Schematics .....	7
Input-Output.....	7
Filters (3 off).....	7
BOM .....	8
Component Placement .....	9
Assembly .....	11
Input-output PCB .....	11
Filter PCBs .....	13
Interconnecting IDC Cable .....	14
Putting it together.....	15
Adjustments.....	17
Afterthoughts – Mixer Phase .....	18

## Introduction

The resonance filter is intended to emulate static resonances that are typically found in acoustic musical instruments.

There are three non-overlapping frequency bands:

- Low range - 60 to 300 Hertz
- Medium range – 300 to 1k5 Hertz
- High range - 1k5 to 7k5 Hertz

Emphasis (or Q) can be adjusted between 0.5 and 10, and each band has its own gain control.

There are separate output level controls for the resonator (filter) and dry signal mix.

The build consists of four PCBs – one doing the input and output, plus three filters.

### Polymoog

The Polymoog used a 4016 CMOS switch for filter mode switching (here, we just use a slide switch). As this integrated circuit operated on the positive supply only, Polymoog internal signals used a virtual ground (Vch) at 1/3 of the supply voltage. This may form part of the character and “vintage” sound of the filter.

The Polymoog’s filter could be switched between Low pass (LP), band pass (BP) and high pass (HP) modes. In addition, a band notch (BN) mode is available, that inverts the polarity of the middle frequency band in relation to the high and low bands.

Note that the filter circuits emulate those in the Polymoog – warts and all.

## Options (read me first!)

### ***“Vintage” or “modern” build:***

1. “Vintage”
  - a. Use MC1458 or equivalent dual op amps the same as the original Polymoog. The Polymoog specified MC1458C, I used MC1458P. Any 8 pin DIL package dual op-amp should work.
  - b. On the input-output PCB:
    - i. Install the Vch voltage reference components (R12, R13, R14, C5)
    - ii. Install the four resistors R17 – R20 (located behind the mode switch).
    - iii. Jumper set to Vch position.
2. “Modern”:
  - a. Use TL072 op-amps (or a lower noise op-amp can be used if they have the same pinout).
  - b. On the input-output PCB:
    - i. Do not install the Vch components.
    - ii. Do not install the four resistors R17 – R20.
    - iii. Jumper set to 0V position.

### ***Level Matching***

The internals of the Polymoog run at *roughly* “line” level – Eurorack signal levels ( $\pm 5V$ ) are hotter than this.

You have the following build options:

- a. Default level -  
R4 = 47k, R9, R21 = 47k – the input buffer has a gain of 0.5, the output buffer a gain of 2.0 : the overall gain through the filter (Dry signal) is 1.0.  
This gives a lower noise level, but will more readily clip if Eurorack input signal levels ( $\pm 5V$ ) are used with high filter emphasis (resonance) settings.
- b. “Eurorack” level –  
R4 = 10k, R9, R21 = 220k – the input buffer has a gain of 0.1 (1/10), the output buffer a gain of 10.0 : overall gain through the filter (Dry signal) is still 1.0.  
Less risk of clipping with Eurorack signal levels, but you can get noticeable noise at the output if you then use the module with line level signals using HP or BP modes with high emphasis settings.
- c. Something halfway between the above two options as a compromise – adjust R4 and R9 values to suit (e.g. R4=22k, R9,R21=100k).
- d. Note that R9 and R21 must always have the same value.
- e. Switchable level (use a DPDT switch) - can be added but not supported on the supplied PCB or panel.

- f. Variable gain (using a stereo potentiometer to replace R4 and R9) - can be added but not supported on the supplied PCB or panel.

### ***Gain and clipping***

At maximum emphasis (Q), each filter has a gain of around x4 (+12dB) at the resonant frequency. Careful use of the gain controls is therefore needed if you want to avoid clipping. If using the Vch reference option (virtual "ground" at +4 volts) there is less headroom on the positive waveform. Some of the resonator output waveforms are not symmetric so you can get significant positive or negative clipping.

With the component values given, the resonator has a gain (dry signal path) of approximately unity. The maximum signal level through the filters is set by R4 (on the input buffer), the corresponding resistors on the output buffer are R9 and R21. R9 and R21 must always have the same value.

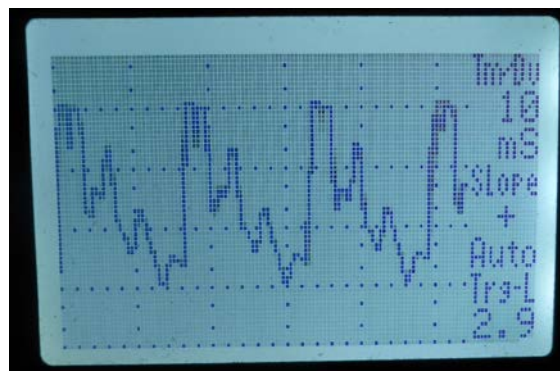

**Sawtooth wave input, with high resonance, high gain but no clipping.**

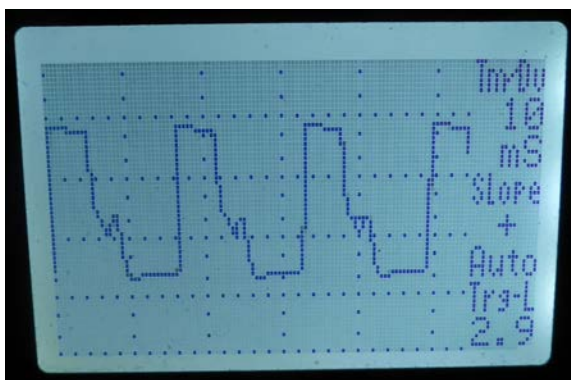

**“Modern” build, Input level turned up – symmetrical clipping.**

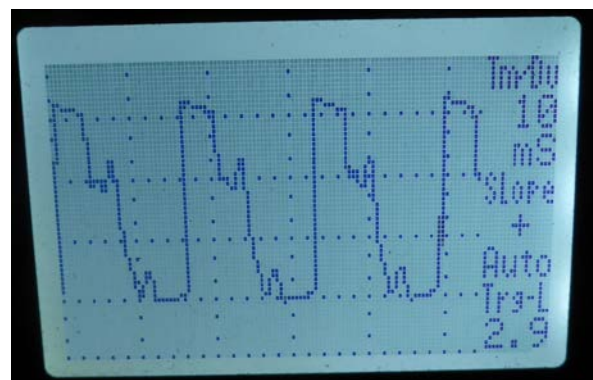

**“Vintage” build, Input level turned up – clipping is more asymmetrical.**

## PCB Versions

This build document refers to PCBs of 2016 manufacture:

- Input/output is marked - "PCB (c) M.Graves 2016"
- Filter PCB is marked - "PCB (c) M.Graves v1-3 2016"

If you have PCBs marked with earlier dates or versions, please refer to version 1.7 of this build document.

## Power Consumption

+12V 18 mA

-12V 17 mA

(using MC1458)

## PCBs

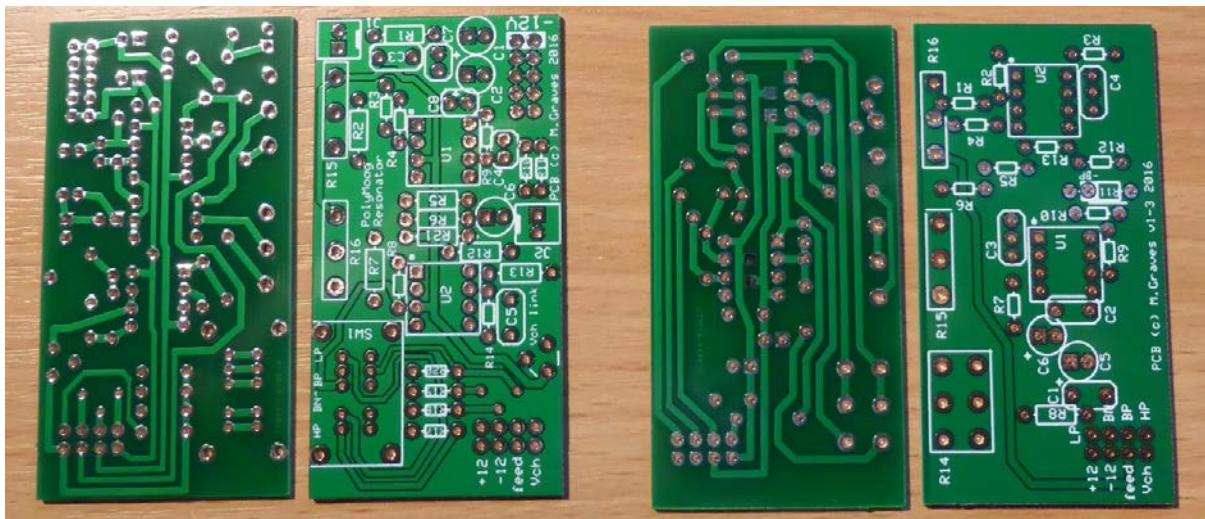

The Input/output PCB is on the left, the filter PCB on the right (3 filter PCBs are required).

**Note that component numbers are specific to each PCB type (i.e. the input-output PCB and the filter PCB both have an R1, R2 etc.).**

# Schematics

## Input-Output

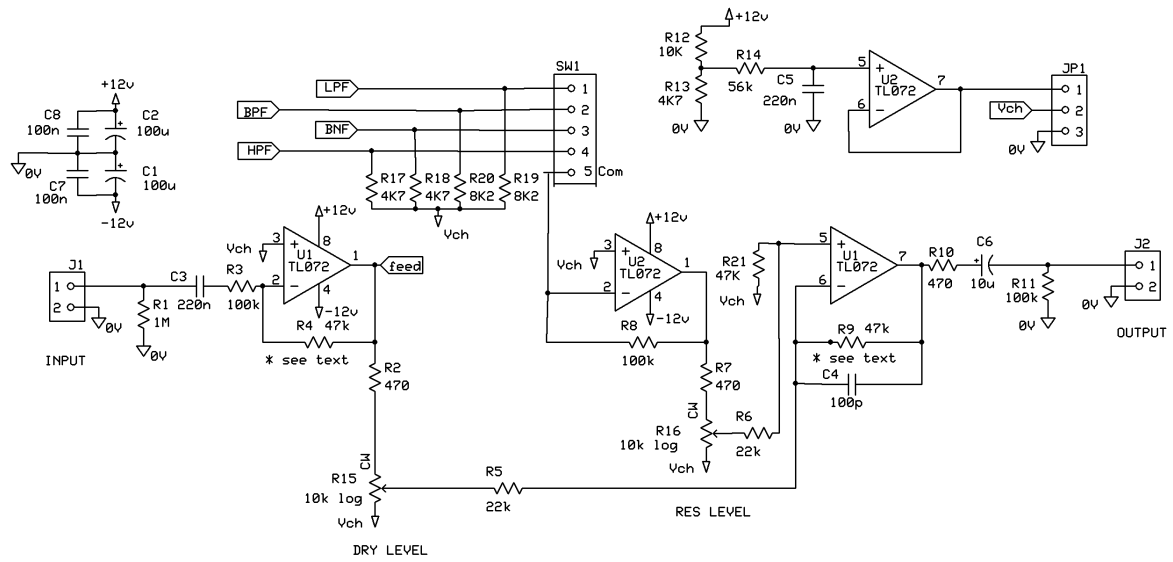

## Filters (3 off)

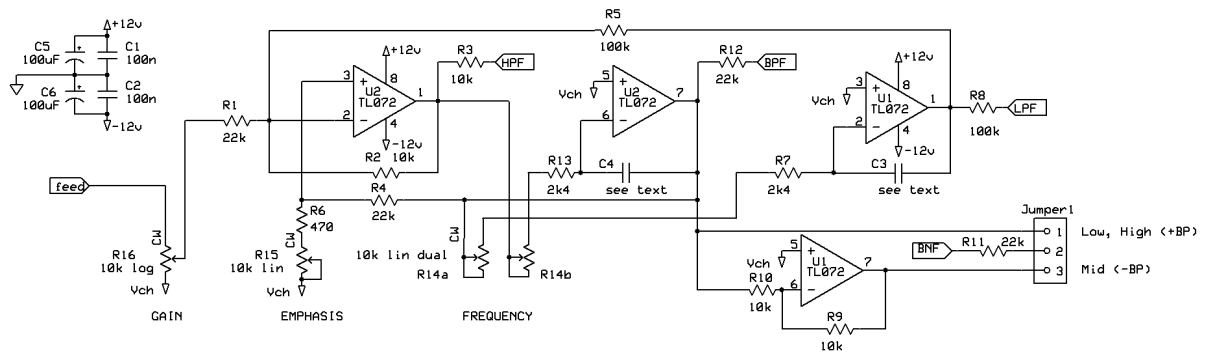

## BOM

### Resistors

5 off 470

6 off 2k4

12 off 10k

14 off 22k

3 off 47k

9 off 100k

1 off 1M

3 off 4k7 (if Vch used)

2 off 8k2 (if Vch used)

1 off 10k (if Vch used)

1 off 56k (if Vch used)

I recommend using 0.25W resistors if possible

### Capacitors

2 off 100uF 25V

6 off 10 to 100uf 25v (filter boards C5,C6)

1 off 10uF 25v

8 off 100nf ceramic

1 off 22pf Ceramic

2 off 2.7nf polyester film (PCB will take 2.5mm or 5mm lead pitch)

2 off 12nF polyester film (PCB will take 2.5mm or 5mm lead pitch)

2 off 68nF polyester film (PCB will take 2.5mm or 5mm lead pitch)

1 off 220nf polyester film (PCB is 5mm lead pitch)

1 off 220nf polyester film (PCB is 5mm lead pitch) (if Vch used)

### **Optional:**

6 off 100nf SMT 1206 ceramic capacitors

### Semiconductors

8 off TL072 or MC1458 (or you can use TL072 for the input and output, and 1458 for the filters). The original Polymoog used MC1458CR, I used MC1458P.

### Potentiometers

3 off 10K Lin dual (stereo) Alpha 16mm

3 off 10K Lin Alpha 16mm

5 off 10K Log Alpha 16mm

### Hardware/Misc

8 off 8 pin DIL sockets

1 off 2P4W (2P4T) slide switch (SK-24D04 )

1 off 10 way PCB header plug

4 off 8 way PCB header plug

1 off 8 way (or 10 way ) IDC header cable – 4 connectors spaced at 47mm approx. intervals on the cable.

11 off knobs to suit your system (I used Davies 1900H clones)

2 sockets to suit your system (the panel is drilled 6mm for 3.5 mm jacks)



## Component Placement

### Input-Output PCB

Component	Value
C1	100uF 25V
C2	100uF 25V
C3	220nF
C4	22pF
C5 (only if Vch used)	220nF
C6	10uF 25v
C7	100nF ceramic - mounted across pins of C1
C8	100nF ceramic - mounted across pins of C2
R1	1M
R2	470
R3	100k
R4	47k - see text.
R5	22k
R6	22k
R7	470

R8	100k
R9	47k- see text.
R10	470
R11	100k
R12 (only if Vch used)	10k
R13 (only if Vch used)	4k7
R14 (only if Vch used)	56k
R15	10k log Alpha 16mm
R16	10k log Alpha 16mm
R17 (only if Vch used)	4.7k
R18 (only if Vch used)	4.7k
R19 (only if Vch used)	8.2k
R20 (only if Vch used)	8.2k
R21	47K - see text.
SW1	2 pole 4 way slide switch – SK-24D04
U1, U2	TL072 or MC1458 – see text.

## Filter PCB

Component	High Filter	Medium Filter	Low Filter
C1	100nf	100nf	100nf
C2	100nf	100nf	100nf
C3	2.7nF	12nF	68nF
C4	2.7nF	12nF	68nf
C5	10 – 100uF	10 – 100uF	10 – 100uF
C6	10 – 100uF	10 – 100uF	10 – 100uF
R1	22k	22k	22k
R2	10k	10k	10k
R3 (HP sum)	10k	10k	10k
R4	22k	22k	22k
R5	100k	100k	100k
R6	470	470	470
R7	2.4k	2.4k	2.4k
R8 (LP sum)	100k	100k	100k
R9	10k	10k	10k
R10	10k	10k	10k
R11 (BN sum)	22k	22k * connected to additional pad marked "-BP" on the PCB	22k
R12 (BP sum)	22k	22k	22k
R13	2.4k	2.4k	2.4k
R14	10K Lin dual Alpha 16mm	10K Lin dual Alpha 16mm	10K Lin dual Alpha 16mm
R15	10K Lin Alpha 16mm	10K Lin Alpha 16mm	10K Lin Alpha 16mm
R16	10K Log Alpha 16mm	10K Log Alpha 16mm	10K Log Alpha 16mm
U1, U2	TL072 or MC1458	TL072 or MC1458	TL072 or MC1458

## Assembly

### ***Input-output PCB***

Populate the Main PCB as shown on the silkscreen, starting with the lowest profile components, so:

- Resistors
- IC sockets. Note that pin 1 has a square pad and is marked with a dot.
- Non-electrolytic capacitors
- Power and interconnecting headers
- Electrolytic capacitors. The positive pin has a square pad.
- Potentiometers, switch (if the potentiometers have plastic dust covers, you may need to remove them). Make sure the potentiometers are all well seated on the PCB as clearances are small.

Please observe correct polarity of the electrolytic caps, ICs etc!

Connections to the input and output sockets:

- The input connection is marked "J1" on the PCB.
- The output connection is marked "J2" on the PCB.
- On both input and output, the pin with the square pad is the signal, the pin with the round pad is 0V.
- You can solder wires directly to the PCB or use a (molex or similar) plug and socket.

If you are not installing the components for the Vch virtual ground, it will look like this.

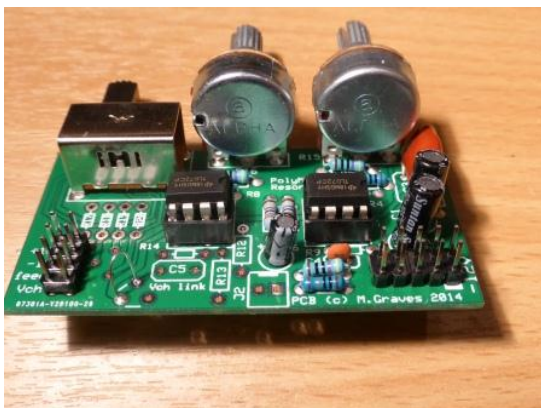

If you are using Vch, it will look like this:

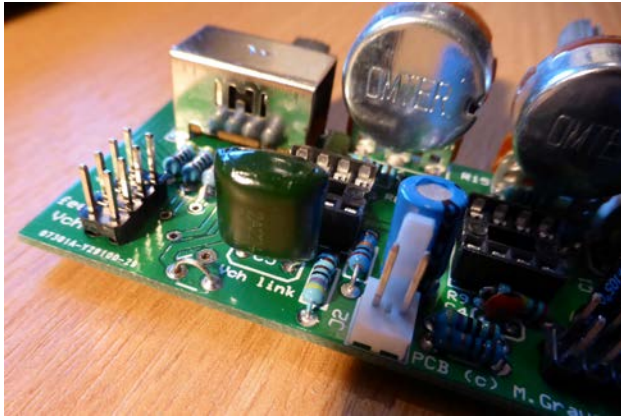

## ***Filter PCBs***

Populate each of the filter PCBs as shown on the silkscreen, starting with the lowest profile components, so:

- Resistors
- IC sockets. Note that pin 1 has a square pad and is marked with a dot.
- Non-electrolytic capacitors.
  - There are pads to take 5mm or 2.5 mm pitch filter capacitors. If using 2.5mm pitch capacitors, make sure you use the correct pads.
- Inter-connecting headers.
- Electrolytic capacitors. The positive pin has a square pad.
- Potentiometers (if the potentiometers have plastic dust covers, you may need to remove them). Make sure the potentiometers are all well seated on the PCB.

The components are identical for each filter PCB, with the exception of the two filter capacitor values.

I recommend that you mark the filter board as L/M/H as you assemble them.

**Take care with R11.** On the “middle” range filter PCB, it connects to the pad marked “-BP” to give the “band notch” mode, and will look like this:

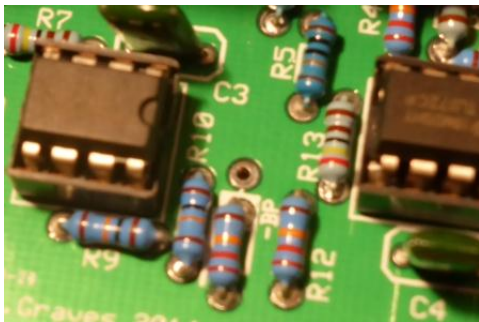

On the “low” and “high” PCBs, it will look like this:

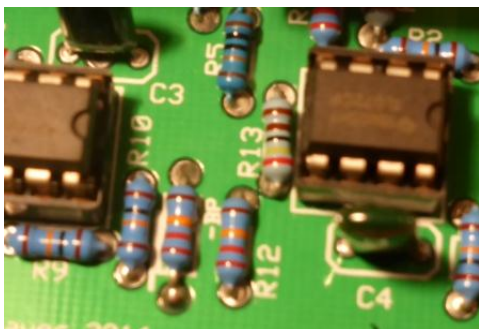

I recommend that you trim the pins of the filter PCB potentiometers, especially the centre pin. The PCB's are close together and you need to avoid shorts between these potentiometer pins and the body of the potentiometer on the adjacent filter.

### **Filter Board Decoupling capacitors**

There are several earlier **filter board** versions – all 2016 manufacture PCBs have the following decoupling capacitors:

- positive power rail:
  - C5: 100uF 25V electrolytic (or anything you have handy e.g. 10uF 25v, 47uF 25v)
  - C1: 100nf ceramic
  
- negative power rail:
  - C6: 100uF 25V electrolytic (or anything you have handy e.g. 10uF 25v, 47uF 25v)
  - C2: 100nf ceramic

**If** you find the filter is noisy (particularly at high Q in HP or BP mode if you are using a high gain at the output amplifier), there is then the **option** to add an additional 100nf SMT capacitor between the power rails (located underneath each op amp on the filter board) to try and fix this. These were an afterthought in case anyone had an issue.

Note that it is possible to "over bypass" things. Depending on the exact op-amps being used I would have either:

- C5, C6, with C1 and C2, with no SMT caps
- C5, C6, with C2 and the SMT capacitors between power rails, but with **no** C1.

Don't install the SMT capacitors unless you find you have a specific problem with excessive noise in HP and/or BP modes on your system.

### ***Interconnecting IDC Cable***

This needs four female connectors spaced at approximately 47mm intervals. The required total cable length is approximately 160mm.

As 8 way IDC sockets are quite rare (and relatively expensive), a 10 way cable can be used instead.

## ***Putting it together***

If using the commercially made panel, remove the protective film from *both sides* of the panel first.

The follow approach is recommended; I would assemble each PCB to the panel and test individually in order:

Input-output PCB testing:

- Check for power rail shorts on the input-output PCB.
- Install the PCB on the panel and wire up the input and output sockets
- Power up and check for +12V at pin 8 of the op-amps, -12V at pin 4.
- If using the Vch option, check that there is approx. +4V present on the Vch wire link.
- Connect the input to a signal source, and the output to some suitable amplification.
- Check that the “Dry Level” control operates correctly (the “Res Level” control won’t have any effect yet – no filters are connected!).
- If that works, we know that the input and output buffers are working OK.

Connect the IDC inter-connecting cable. This can be an 8 or 10 way cable – if a 10 way it will overhang the header:

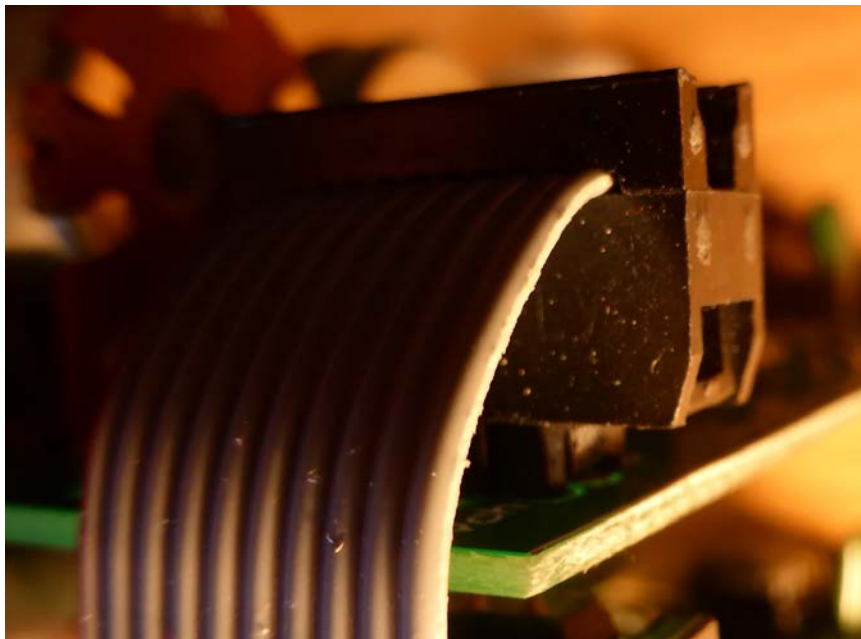

## Filter PCBs

I recommend that you assemble these to the panel in the order Low, then Medium, then High (moving up the panel one at a time).

- Check for power rail shorts on the filter PCB.
- Install the PCB on the panel and connect the IDC inter-connecting cable.
- Check that pins of the potentiometers do not short against the pots on the board below:

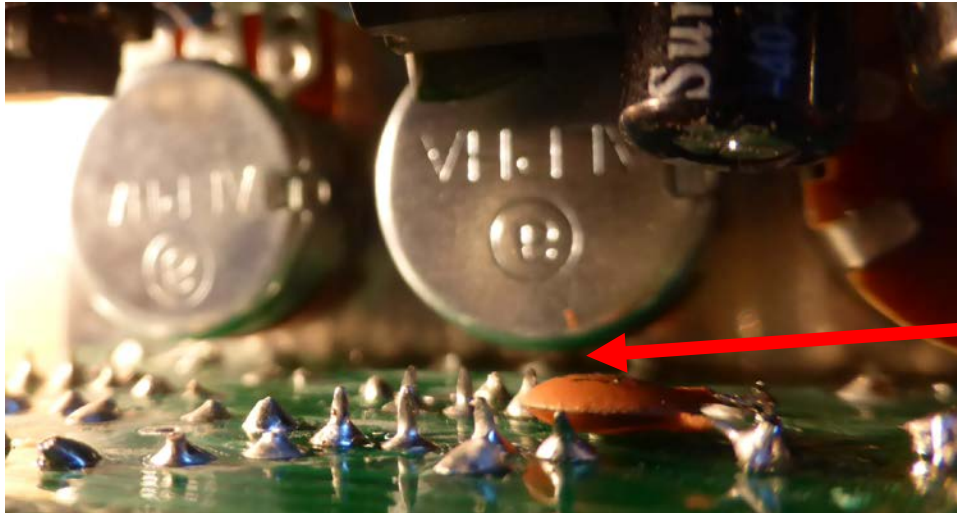

- Power up. Check for +12v at pin 8 of the op-amps, -12v at pin 4. **Note that if using Vch , the ground plane (upper foil) of the filter PCBs are at +4V, not 0V !**
- If using Vch, check for approx. +4v at pin 3 or pin 5 of U1 or U2 (on the filter board). Ensure you measure against a 0V reference (see above note!).
- Connect the input to a signal source, and the output to some amplification.
- Check that the “Dry Level” control still operates correctly.
- Advance the “Res Level” control, you can now check that the filter Gain , Emph and Freq controls work. Remember:
  - You won’t get any output from “Res Level” if the filter “Gain” is set at zero.
  - You need to feed in a signal that has content that is within the filter band being tested – for the “low” band, this means bass!

If that all works OK, we know that this filter PCB is working OK.

Repeat for the other two filter PCBs. It should now look like.....



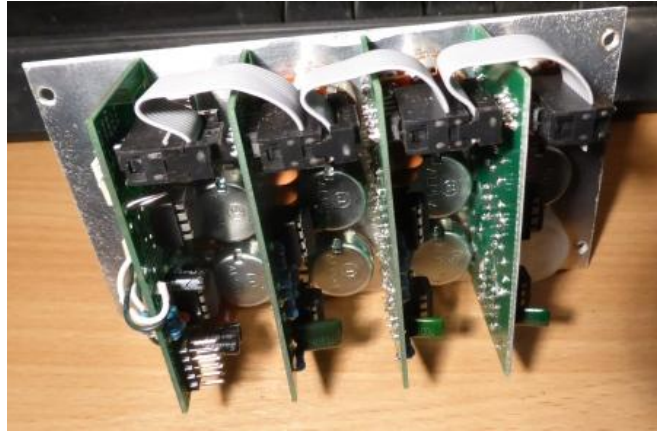
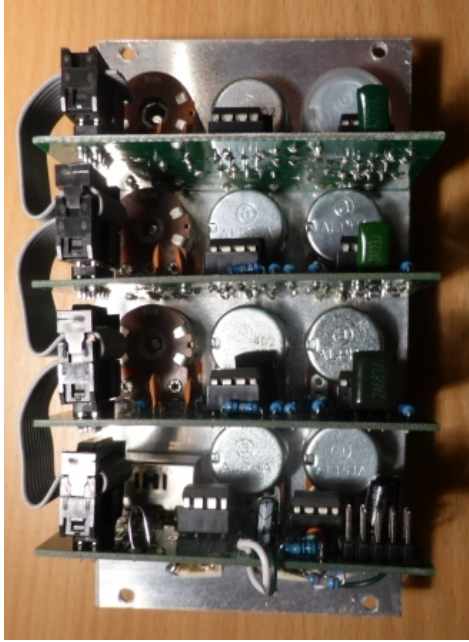

## **Adjustments.**

There are no adjustments – use creatively and enjoy!

## Afterthoughts – Mixer Phase

The latest Input-output PCB is designed to mix the RES and DRY signals “in-phase”, as on the original Polymoog - note that I am totally ignoring the effect of the complex frequency dependant phase changes that occur within the filters themselves, just the effect of the mixer itself.

Earlier versions of this resonator, and a similar design published by the late Juergen Haible, mixed these signals out of phase - the RES signal was inverted in relation to the DRY signal.

It is possible to modify the current mixer PCB to mix RES with DRY “out of phase”.

This can be achieved by modifying R5 and R6:

- Solder R5 to the PCB at both ends.
- Solder the end of R6 that is closest to the potentiometers to the PCB.
- Do **not** solder the end of R6 that is closest to C6 to its PCB pad, instead solder it to the adjacent lead of R5 and *its* pad. Make sure that R6 does not touch the original “R6” pad. It should look something like this (note: this is a mock up without the PCB joints soldered):

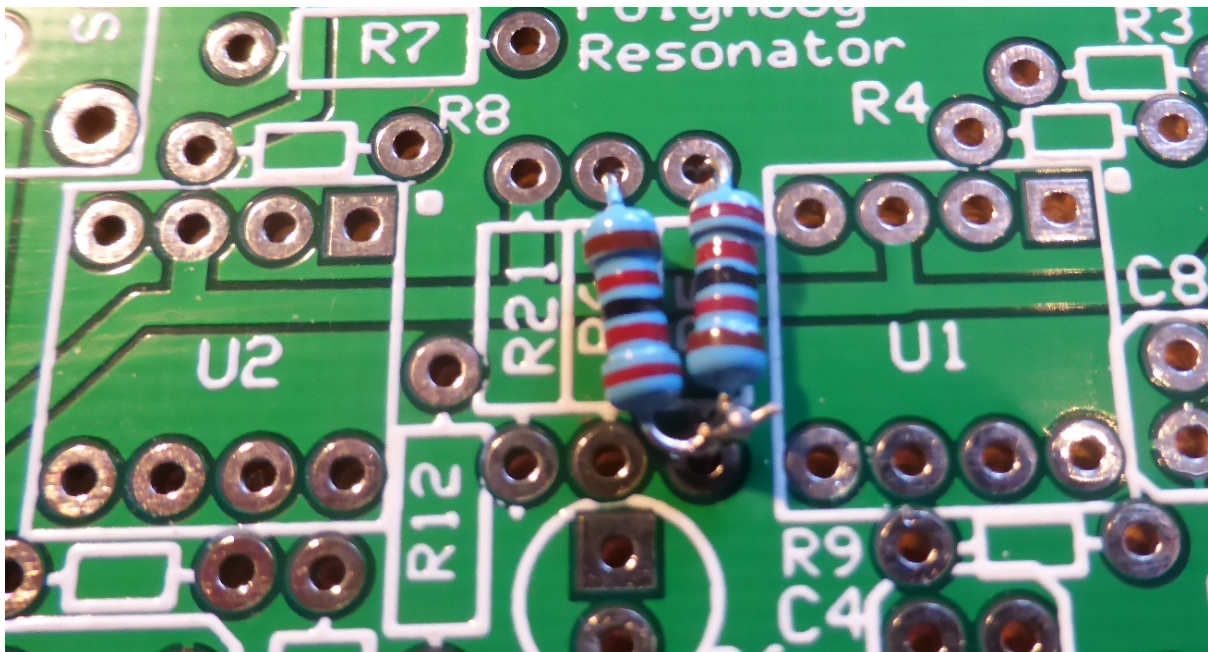

I am not going to recommend which is the better solution; it depends on how you use your resonator and on your individual taste.