



OVERVIEW

For the most recent version of this document please visit <http://www.thonk.co.uk/documents/strakal>

For all technical support please visit <http://bit.ly/1h4aVPk> on Muffwiggler.

The Strakal Brulu manual is here http://www.thonk.co.uk/documents/strakal/StrakalBrulu_ReGrenvEo.pdf



All Thonk kits are sold under our standard Terms and Conditions - <http://www.thonk.co.uk/faq/>

DIY INSTRUCTIONS

This document gives detailed instructions that assume you have purchased a complete kit from www.thonk.co.uk. It also assumes no previous knowledge of electronics. To learn to solder try http://youtu.be/l_NU2ruzyc4 and the **Adafruit guide to excellent soldering** – <http://bit.ly/1l77tF4>

Watch and understand that whole YouTube video! If you're not achieving the results shown in the video then you need to buy new tools or seek advice.

You will not end up with a working module otherwise.

TOOLS REQUIRED

Soldering iron, snipe nose pliers, wire strippers, small flat head screwdriver and diagonal cutters AKA snips AKA side-cutters. A Digital Multimeter is necessary for calibrating this module accurately but you can do it by ear to taste. Thonk sell a range of inexpensive tools here - <http://bit.ly/1jxqF3n>



SOLDER JOINTS

Your solder joints should look like those shown as 'OK' below, they should have that neat conical shape on **BOTH sides of the PCB**. If they don't look the same on both sides then stop! Work out why from the soldering guides linked and don't continue until you are getting those results.

This isn't just OCD talking, you are very likely to end up with a destroyed, damaged or defective unit if you're not hitting that standard.

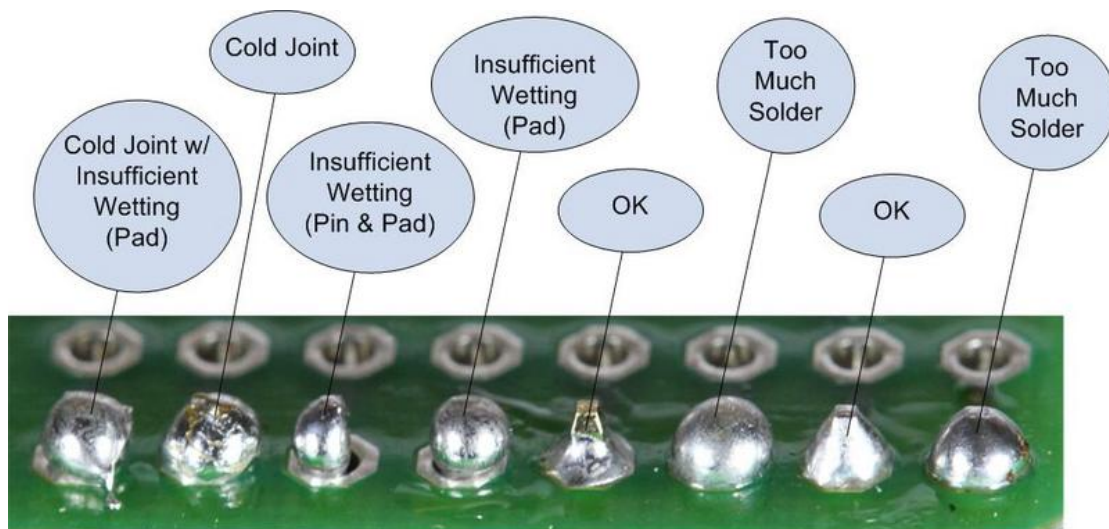

This photo is from the **Adafruit guide to excellent soldering** - <http://bit.ly/1jxqF3n> and is reproduced under an Attribution-Sharealike creative commons license - <http://creativecommons.org/licenses/by-sa/3.0/>



STRAKAL BRULU BUILD INSTRUCTIONS

1.

Start by emptying **BAG A** into a bowl or container. This makes it much easier to pick parts as you need them and you're less likely to lose anything.

2.

The first job is to solder all the resistors.

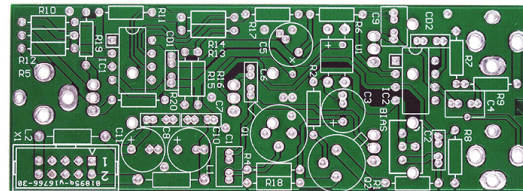

3.

Start by soldering the single 1K resistors in position R18.

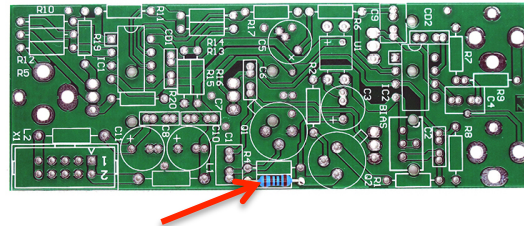

4.

Solder the two 100R resistors in positions L1 and L2.

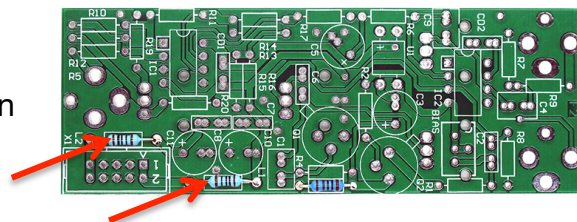

5.

Solder the two 100K resistors in positions R4 and R13.

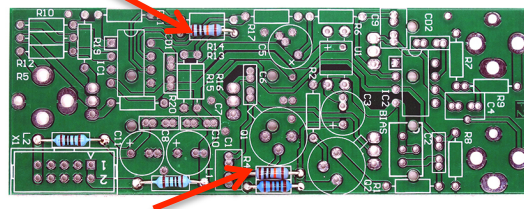



6.

Solder the two 1M resistors in positions R7 and R8.

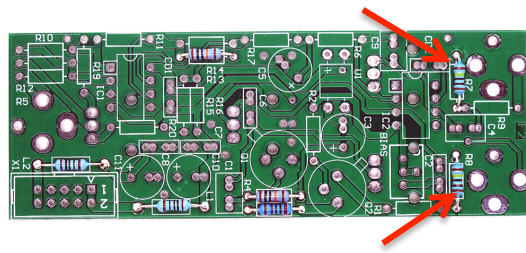

7.

Solder the single 220R resistor in position R9.

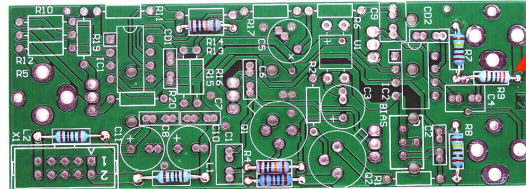

8.

Solder the single 390R resistor in position R17.

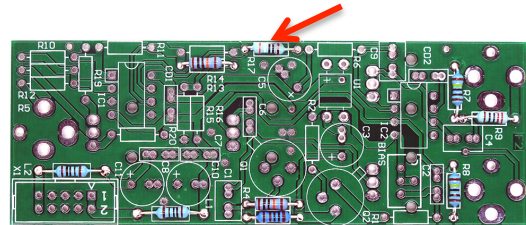

9.

Solder the single 470R resistor in position R1.

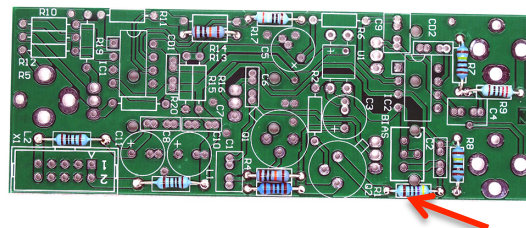

10.

Solder the single 12K resistor in position R16.

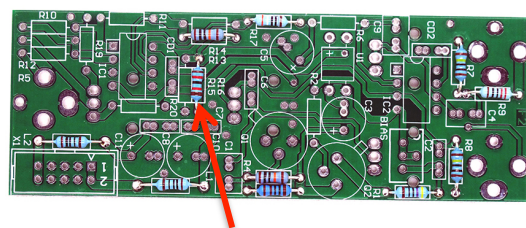

11.

Solder the single 15K resistor in position R15.

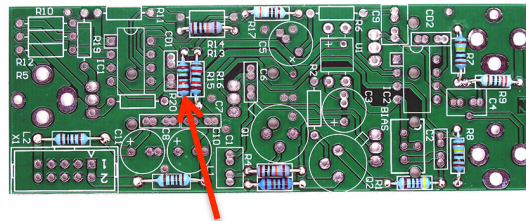



12.

Solder the single 33K resistor in position R2.

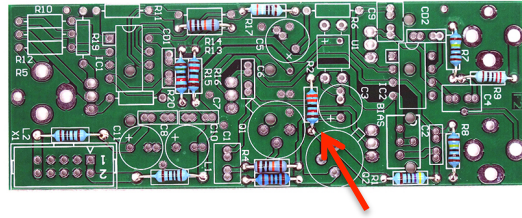

13.

Solder the five 47K resistors in positions R5, R10, R11, R12, R14

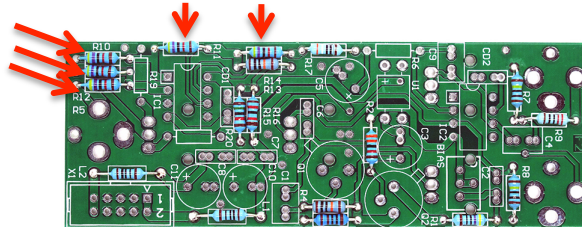

14.

Solder the three 4.7K (4K7) resistors in positions R6, R19, R20. You should now have no resistors left.

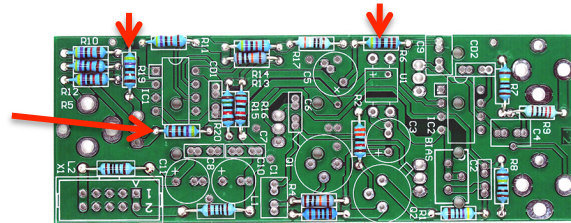

15.

Solder the two 8 pin IC sockets. Ensure the notches in the sockets match the silkscreen.

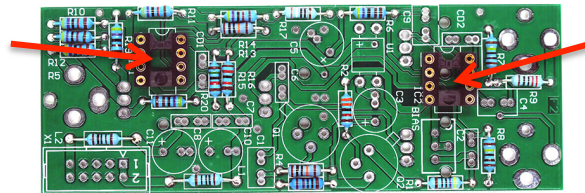

16.

Solder the Vactrol.

Note the orientation of the text on the Vactrol.

The plus symbol on the PCB should be closest to the yellow dot on the Vactrol body.

Note also that on one side of the Vactrol the leads are further apart, this end of the vactrol is positioned closer to the edge of the PCB.

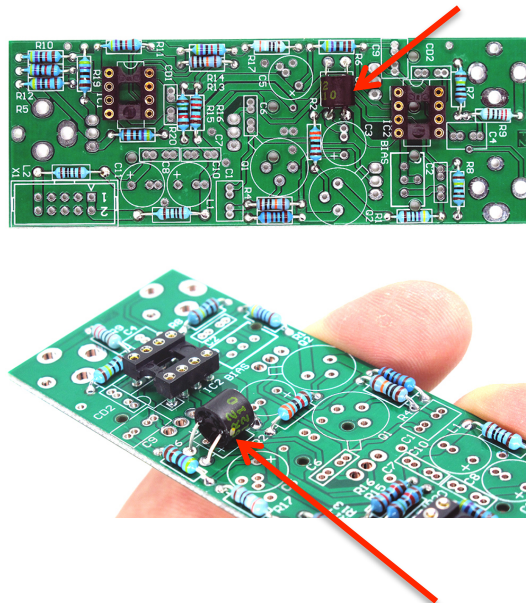

NOTE! – The orientation is vital.



17.

Solder the single 1nF ceramic capacitor into position C9. The orientation of this component does not matter.

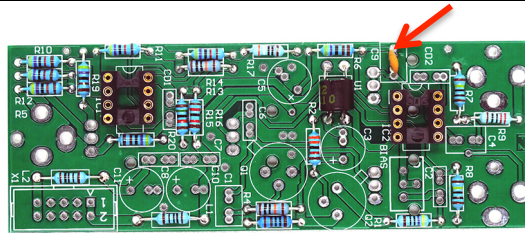

18.

Solder the single red 10nF film capacitor into position C2. The orientation doesn't matter. This capacitor has the marking '10nJ63'

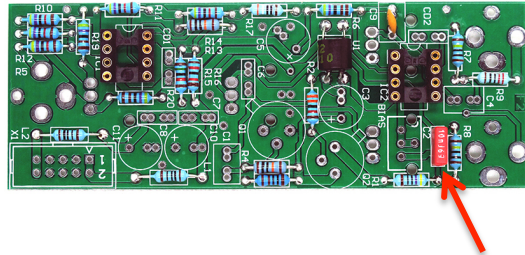

19.

Solder the six red 100nF film capacitor into positions C1, C6, C7, C8, CD1, CD2. The orientation of these components does not matter.

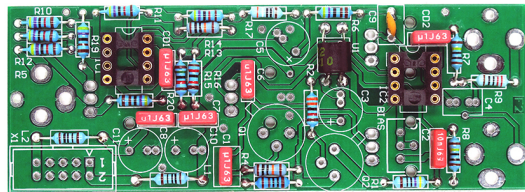

This capacitor has the marking 'u1J63'

20.

Solder the single 1uF film capacitor into position C4. The orientation of this component does not matter.

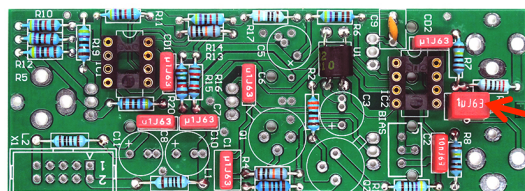

This capacitor has the marking '1uJ63'.



21.

Solder the shrouded power header into place.

NOTE! – The orientation is vital. The gap in the rectangular shroud should point inwards.

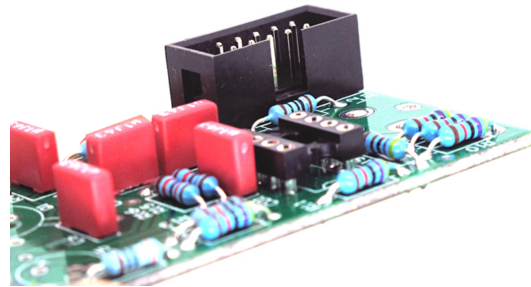
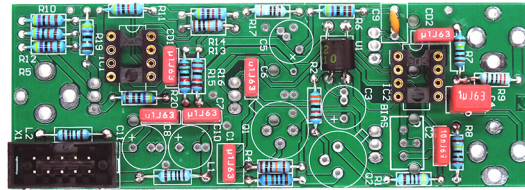

22.

Solder the four 47uF electrolytic capacitors into positions C3, C5, C8 and C11.

NOTE! – The orientation is vital. The longer lead should go into the hole marked +

NOTE! – Ignore this pad marked on C5.

NOTE! – On all these electrolytics there are two holes provided for the negative or shorter lead, you can use either.

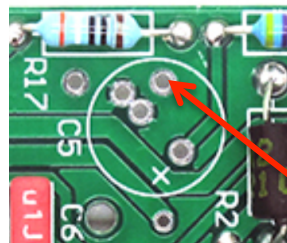
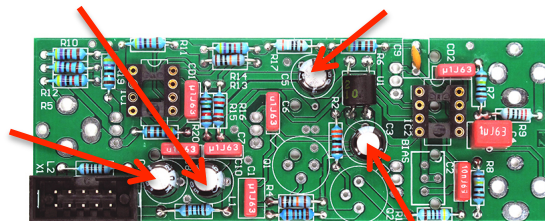

do not use

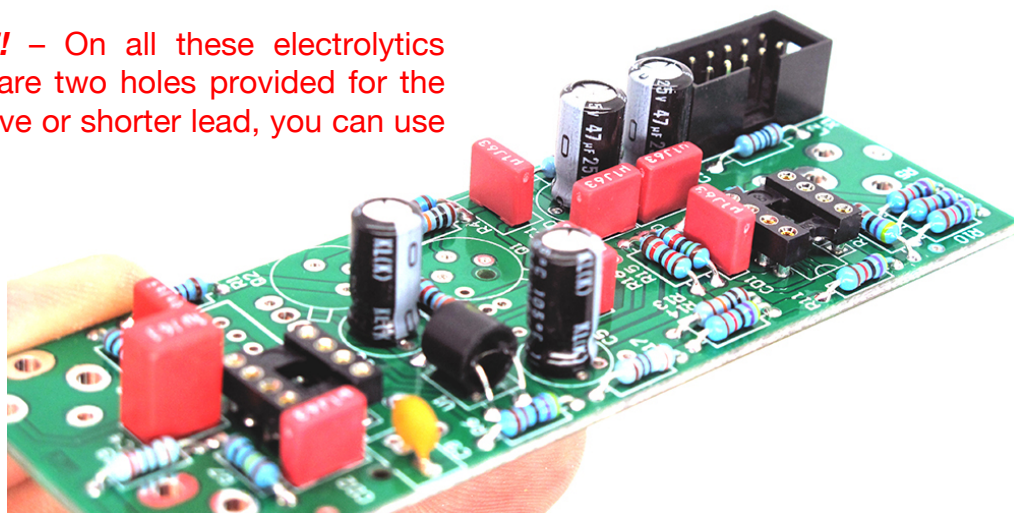

23.

Solder the trimmer into place in the positions identified. You may need to bend the legs a little to get them to fit. Make sure none of the legs are touching.

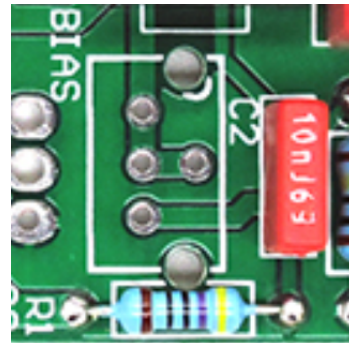
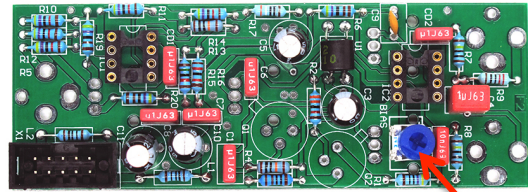

24.

Next you need to modify all four pots.

First snap off the little metal tab shown. This is easily done with pliers or snips.

If you don't do this you may have problems fitting the faceplate.

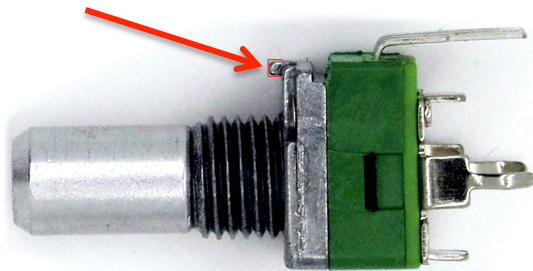

25.

Next you need to snip off the two smaller feet on all the pots. You can repeatedly bend them to snap them off, but you must be careful to not completely break off the metal plate underneath.

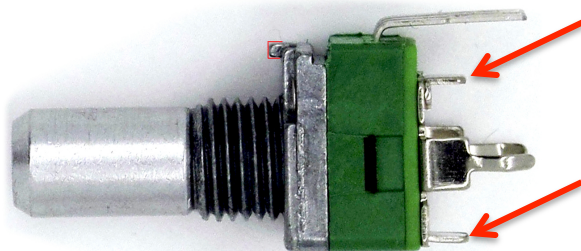



26.

They should now all look like this.

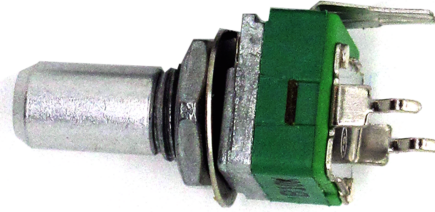

27.

Put the four pots in the positions shown but **DO NOT SOLDER** yet.

Fuzz – B10K
Feedback – B1M
Input Vol – A50K
Gain Out Volume – B100K

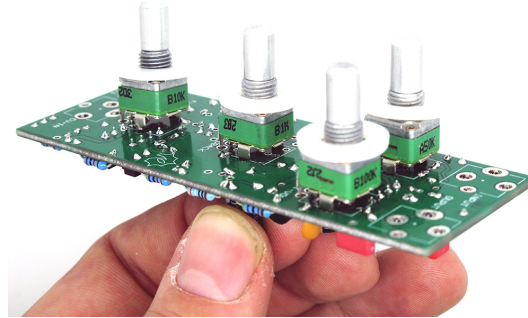

28.

Put the three jacks in the positions shown but **DO NOT SOLDER** yet. Note the Fuzz CV jack is rotated 90 degrees compare to in and out jacks.

Put a plastic washer onto each of the pots.

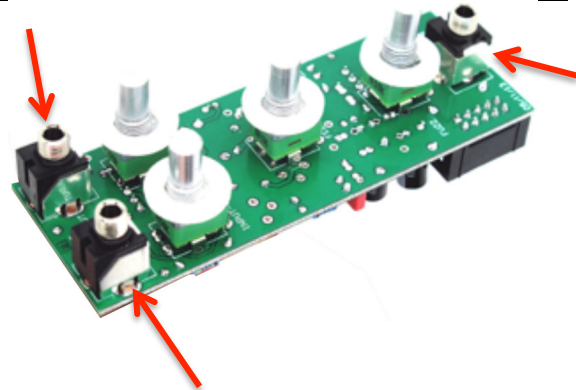

29.

Now put the panel on and hand tighten the three jack nuts and four pot nuts.

NOTE! – The image shows a prototype panel without graphics. Mount your finalised panel with the graphics the right way up.

Solder all the pots and jacks. Note that unlike some builds **only the main three pins** on the pots need soldering.

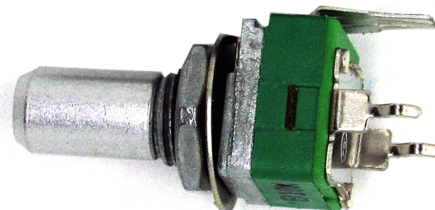



30.

Remove the panel again.

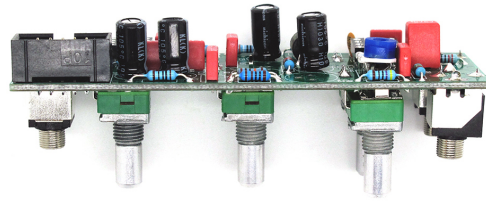

31.

Next you will solder the smaller Germanium Transistor.

NOTE! – The transistor orientation is vital and is not intuitive. Ignore the PCB silkscreen and follow the image below.

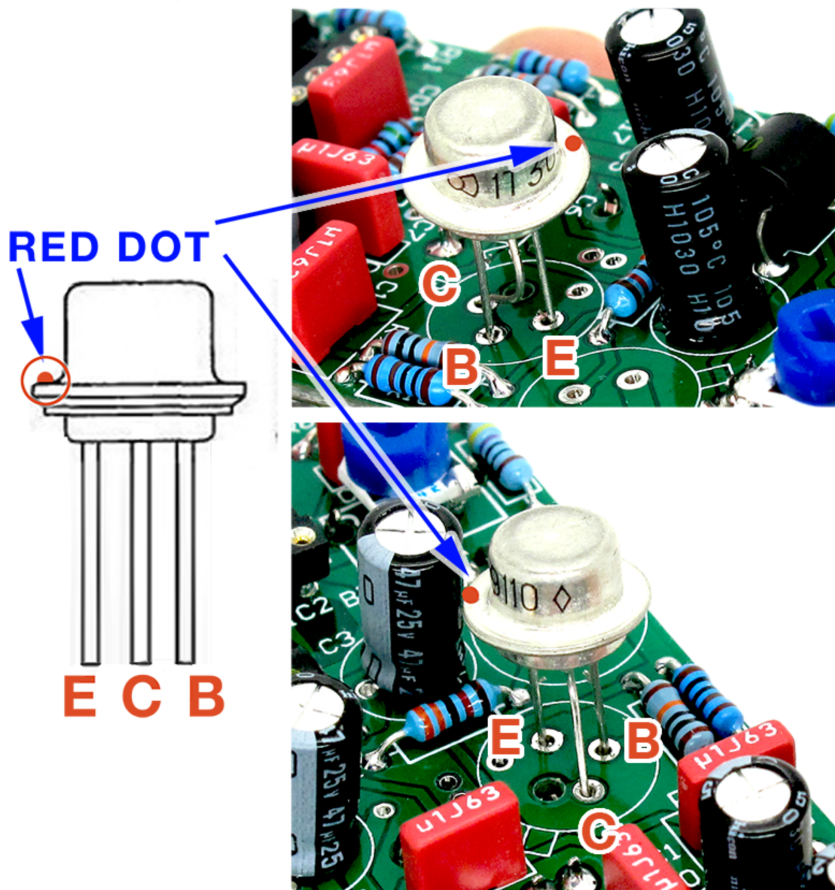
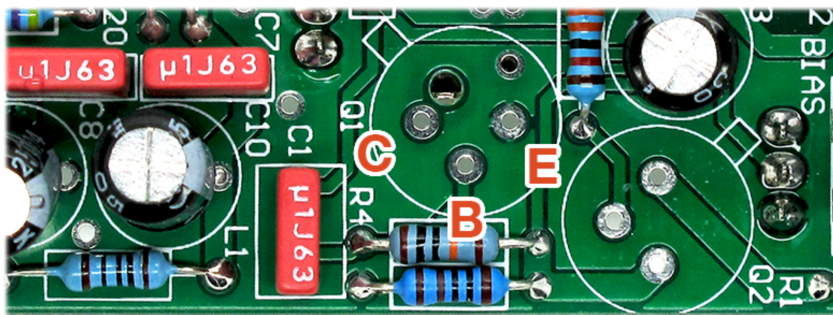



32.

Next you will solder the larger Germanium Transistor.

NOTE! – The transistor orientation is vital and is not intuitive. Ignore the PCB silkscreen and follow the image on this page.

NOTE! – Later on you might need to put a probe on the C pin of this transistor, so mount it high off the board as shown to give you more options for access.

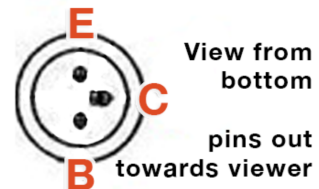
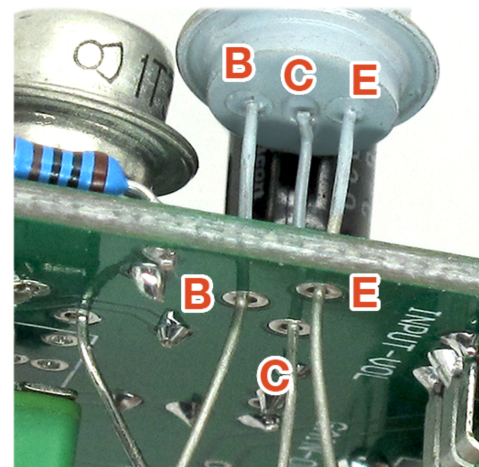
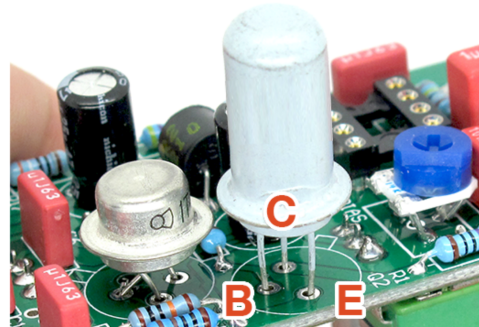
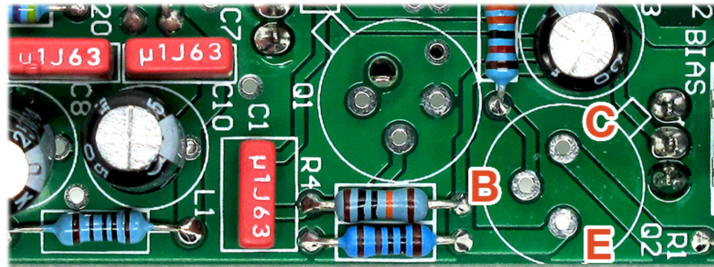

33.

Next insert the TL072 and TL071 ICs.

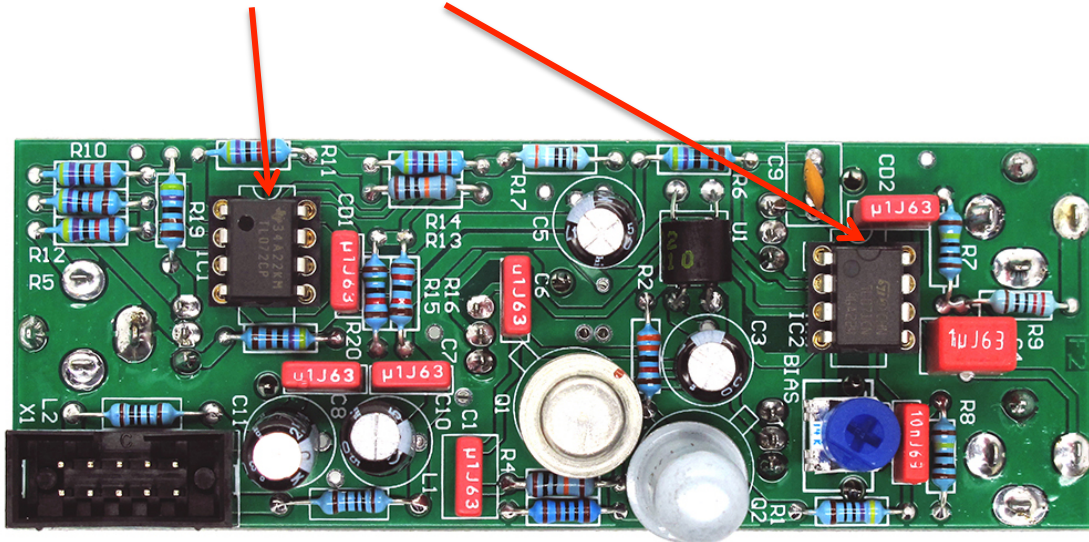

NOTE! – The IC orientation is vital, make sure the notch in the end of the IC or the circle mark are positioned as shown.

34.

Put the metal panel back onto the PCB and put on the knobs.

Insert power cable as shown. The provided cable is keyed correctly. But just in case you use another cable, note that the -12v isn't marked on the board, the red stripe is at the top, not the bottom.

NOTE! – Some of your power cables may not be keyed correctly unlike the one provided. It is advisable to only use the cable provided. You should maybe make a mark on the PCB to indicate where the red stripe should go if this is a concern to you.

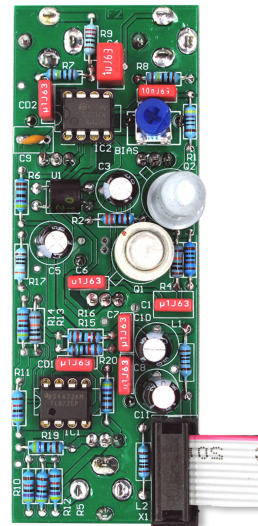



35.

You can now power the module on. You should use a small Philips screwdriver to calibrate the module via the blue trimmer. The best advice from TouellSkouarn is to just trim by ear, I have found if you have the input and output knobs set to midnight and then trim so the feedback knob squeal (resonant self-oscillation) starts to happen sometime around 1 - 2 o'clock then you have a good range of possibilities... but there is not really a 'right or wrong' setting for the trimmer.

If you want to follow the official 'factory' default from TouellSkouarn then with the module powered on, set your multimeter to read DC voltage. Put the Black or COM probe on the ground point shown on the PCB and the Red voltage probe on the 'C' or collector terminal of the larger germanium transistor.

To start turn the trimmer until the DC voltage is showing approximately -5V to -7V.

Not trimming the module will not damage it, but these values are a good starting point for use, the trimmer can alter the sound quite radically in interesting ways though so exploration is encouraged. If it sounds good, it's good 😊

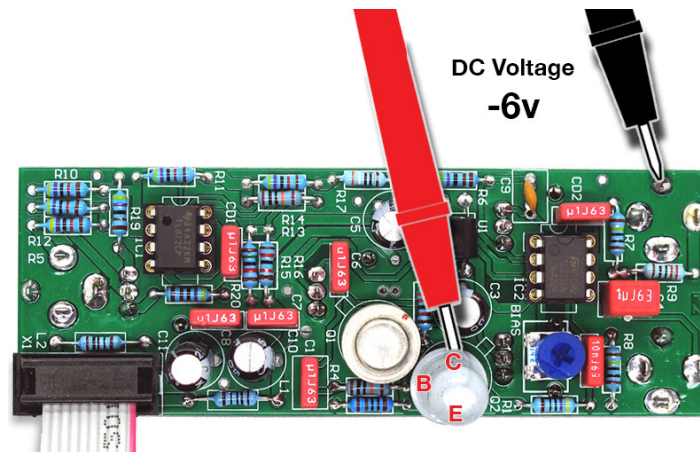



Suggested test points if you need to meter from the front of the board:

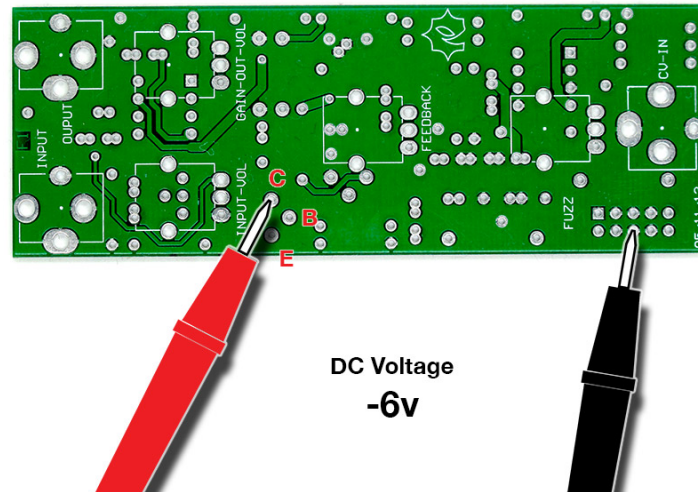

Note! If you left the C leg on Q2 long then don't forget to finally trim it down after!